

The Sphecidae (Hymenoptera)  
of Fennoscandia and Denmark

*by*

O. Lomholdt

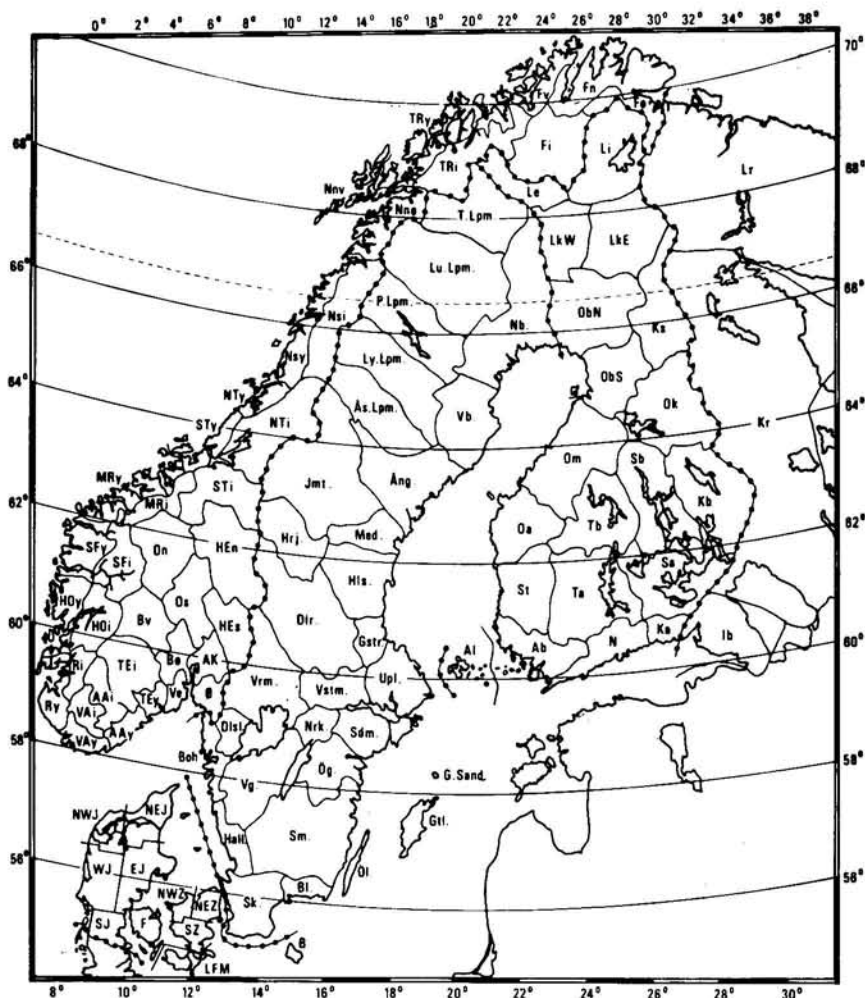

List of abbreviations for the provinces used throughout the text, on the map and in the following tables.

#### DENMARK

SJ	South Jutland	LFM	Lolland, Falster, Møn
EJ	East Jutland	SZ	South Zealand
WJ	West Jutland	NWZ	North West Zealand
NWJ	North West Jutland	NEZ	North East Zealand
NEJ	North East Jutland	B	Bornholm
F	Funen		

#### SWEDEN

Sk.	Skåne	Vrm.	Värmland
Bl.	Blekinge	Dlr.	Dalarna
Hall.	Halland	Gstr.	Gästrikland
Sm.	Småland	Hls.	Hälsingland
Öl.	Öland	Med.	Medelpad
Gtl.	Gotland	Hrj.	Härjedalen
G. Sand.	Gotska Sandön	Jmt.	Jämtland
Ög.	Östergötland	Äng.	Ängermanland
Vg.	Västergötland	Vb.	Västerbotten
Boh.	Bohuslän	Nb.	Norrbotten
Dlsl.	Dalsland	Äs. Lpm.	Åsele Lappmark
Nrk.	Närke	Ly. Lpm.	Lycksele Lappmark
Sdm.	Södermanland	P. Lpm.	Pite Lappmark
Upl.	Uppland	Lu. Lpm.	Lule Lappmark
Vstm.	Västmanland	T. Lpm.	Torne Lappmark

#### NORWAY

Ø	Østfold	HO	Hordaland
AK	Akershus	SF	Sogn og Fjordane
HE	Hedmark	MR	Møre og Romsdal
O	Opland	ST	Sør-Trøndelag
B	Buskerud	NT	Nord-Trøndelag
VE	Vestfold	Ns	southern Nordland
TE	Telemark	Nn	northern Nordland
AA	Aust-Agder	TR	Troms
VA	Vest-Agder	F	Finnmark
R	Rogaland		

n northern    s southern    ø eastern    v western    y outer    i inner

#### FINLAND

Al	Alandia	Kb	Karelia borealis
Ab	Regio aboensis	Om	Ostrobothnia media
N	Nylandia	Ok	Ostrobothnia kajanensis
Ka	Karelia australis	ObS	Ostrobothnia borealis, S part
St	Satakunta	ObN	Ostrobothnia borealis, N part
Ta	Tavastia australis	Ks	Kuusamo
Sa	Savonia australis	LkW	Lapponia kemensis, W part
Oa	Ostrobothnia australis	LkE	Lapponia kemensis, E part
Tb	Tavastia borealis	Li	Lapponia inarenensis
Sb	Savonia borealis	Le	Lapponia enontekiensis

#### USSR

Ib	Ingria borealis	Kr	Karelia rossica	Lr	Lapponia rossica
----	-----------------	----	-----------------	----	------------------

(Continued on back cover)

Copyright for the World  
Scandinavian Science Press Ltd.

Edited by  
Societas Entomologica Scandinavica

Editor of this volume  
Leif Lyneborg

World list abbreviation  
Fauna ent. scand.

Printed by  
Vinderup Bogtrykkeri A/S,  
7830 Vinderup, Denmark

Publication dates  
Part 1: 1 December, 1975  
Part 2: 1 September, 1976

ISBN 87-87491-06-0

## Contents

Introduction .....	7
Diagnosis of the Sphecidae .....	8
Morphology of adult Sphecidae .....	9
Bionomics .....	17
Distribution and zoogeography .....	25
Phylogeny and evolution .....	32
Immature stages .....	37
Key to genera of Sphecidae, larvae .....	41
Key to genera of Sphecidae, adults .....	52
Subfamily Ampulicinae .....	64
Genus <u>Dolichurus</u> Latreille .....	64
Subfamily Sphecinae .....	67
Genus <u>Sphex</u> Linné .....	67
Genus <u>Podalonia</u> Fernald .....	70
Genus <u>Ammophila</u> Kirby .....	75
Subfamily Pemphredoninae .....	81
Tribe Pemphredonini .....	81
Genus <u>Pemphredon</u> Latreille .....	81
Genus <u>Ceratophorus</u> Shuckard .....	102
Genus <u>Diodontus</u> Curtis .....	105
Genus <u>Passaloecus</u> Shuckard .....	113
Genus <u>Stigmus</u> Panzer .....	128
Genus <u>Spilomena</u> Shuckard .....	132
Tribe Psenini .....	143
Genus <u>Mimesa</u> Shuckard .....	143
Genus <u>Psen</u> Latreille .....	150
Genus <u>Mimumesa</u> Malloch .....	152
Genus <u>Psenulus</u> Kohl .....	161
Subfamily Philanthinae .....	169
Genus <u>Cerceris</u> Latreille .....	170
Genus <u>Philanthus</u> Fabricius .....	182
Subfamily Nyssoninae .....	186
Genus <u>Argogorytes</u> Ashmead .....	187
Genus <u>Gorytes</u> Latreille .....	191
Genus <u>Dienoplus</u> Fox .....	199
Genus <u>Bembix</u> Fabricius .....	202

Genus <u>Nysson</u> Latreille .....	204
Genus <u>Didineis</u> Wesmael .....	216
Genus <u>Alysson</u> Panzer .....	218
Subfamily Mellininae .....	223
Genus <u>Mellinus</u> Fabricius .....	223
Subfamily Astatinae .....	228
Genus <u>Astata</u> Latreille .....	229
Genus <u>Dinetus</u> Panzer .....	238
Subfamily Larrinae .....	241
Tribe Tachytini .....	242
Genus <u>Tachysphex</u> Kohl .....	242
Tribe Miscophini .....	252
Genus <u>Miscophus</u> Jurine .....	252
Genus <u>Nitela</u> Latreille .....	259
Tribe Trypoxylonini .....	262
Genus <u>Trypoxylon</u> Latreille .....	263
Tribe Oxybelini .....	267
Genus <u>Belomicrus</u> A. Costa .....	268
Genus <u>Oxybelus</u> Latreille .....	270
Tribe Crabronini .....	286
Genus <u>Crabro</u> Fabricius .....	286
Genus <u>Ectemnius</u> Dahlbom .....	298
Genus <u>Lestica</u> Billberg .....	335
Genus <u>Entomognathus</u> Dahlbom .....	344
Genus <u>Lindenius</u> Lep. & Brullé .....	346
Genus <u>Rhopalum</u> Stephens .....	351
Genus <u>Crossocerus</u> Lep. & Brullé .....	358
Literature .....	412
Catalogue .....	426
Index .....	446

## Introduction

The present work is primarily based on classical faunistic treatments of the European and North American sphecoid faunas. The following monographs represent the foundation of the book: Aurivillius (1904) treated the Swedish fauna of Sphecidae; Balthasar (1972) the Czech; Berland (1925) the French; de Beaumont (1964) the Swiss; Moczar and Bajari (1957 and 1959) the Hungarian; Muesebeck, Krombein, Townes et al. (1951), Krombein et al. (1958, 1967) the North American; Nielsen (1907) the Danish; Noskiewicz and Pulawski (1960) the Polish; Oehlke (1970) the East German; Pulkkinen (1931) the Finnish; Saunders (1896) the British, and Schmiedeknecht (1930) the North and Central European fauna of Sphecidae. Recently Bohart and Menke (1975) published the most important: Sphecoid wasps of the world, a generic revision. As appears from above, the treatment of this fauna in Denmark and Fennoscandia are the most ancient, and the changes, in some cases very extensive, in nomenclature and taxonomy made since then, have necessitated a modern revision of the Nordic fauna. The discovery of several new species within the area also helps to justify a revision. Furthermore, the existing knowledge of the biology, distribution etc. of the species has increased considerably.

I have found it very important to study material from as many localities as possible, and I ask the following institutions and private persons to accept my sincere thanks for invaluable help. My good friends, fil. lic. A. K. Merisuo and E. Valkeila, Finland, through discussions by letter over many years, rendered very valuable aid and inspiration during my work. By their extensive and comprehensive critical papers - dealing mainly with Finnish species - these two colleagues have made important contributions to the sphecoid taxonomy, nomenclature, and biology; also they have willingly permitted me to borrow specimens from their unique private collections. To Lecturer S. E. Abrahamsen, Nr. Nissum, Denmark, I extend a special thanks for successful collaboration and for a great number of biological observations on several species, which have so far never been published.

I am also indebted to Dr. S. L. Tuxen and Dr. B. Petersen, Zoological Museum of Copenhagen, and Prof. J. Leclercq, Gembloux, Belgium, for loan of valuable material of Belgian Sphecidae for comparison. For loan of material I further thank Curator J. Andersen of Tromsøe Museum, Tromsøe, Norway; Fil. lic. H. Andersson, Lund, Sweden; Dr. J. Aubert, Lausanne, Switzerland; Prof. J. de Beaumont, Lausanne, Switzerland; Curator R. Danielsson, Lund, Sweden; Dr. S. Erlandsson, Stockholm, Sweden; Civil Engineer P. I. W. Gleie, Kirke Eskil-



strup, Denmark; Prof. N. Haarløv, Copenhagen, Denmark; Dr. W. Hackman, Helsinki, Finland; Dr. H. Hippa, Turku, Finland; Amanuensis L. -Å. Janzon, Stockholm, Sweden; Mag. scient. B. Jensen, Kalø, Rønne, Denmark; Mr. C. F. Jensen, Århus, Denmark; Dr. E. Königsmann, Berlin, Germany; Mr. A. Lewin, Lerum, Sweden; Curator A. Lillehammer, Oslo, Norway; Prof. C. H. Lindroth, Lund, Sweden; Dr. J. P. van Lith, Rotterdam, Holland; Curator A. Løken, Bergen, Norway; Stud. scient. Thorkild Munk, Copenhagen, Denmark; Dr. J. Oehlke, Berlin, Germany; Lecturer E. Torp Pedersen, Jelling, Denmark; Dr. W. J. Pulawski, Wrocław, Poland; Curator J. Solem, Trondheim, Norway; Prof. O. Sotavalta, Oulu, Finland; Prof. K. Tsuneki, Fukui University, Japan; Mr. C. Vardy, British Museum (Nat. Hist.), London, England, who also read the manuscript and suggested several important alterations; Notary P. M. F. Verhoeff, Utrecht, Holland; Mr. D. Vincent, Columbia, Miss., U.S.A. I extend a cordial thanks to Mrs. A. Volsøe for the great and time-consuming work of linguistic revision of my manuscript. For this purpose The Danish Natural Science Research Council granted considerable support. I am indebted to the Kommitéen för Zoologisk Taxonomi, Naturvetenskapliga Forskningsrådet for supporting a visit to the Swedish Museum of Natural History in Stockholm and to the Museum of Natural History, Gothenburg, Sweden. The final drawings after my sketches were made with experienced skill by Mrs. G. Lyneborg. Some of the drawings in the introductory part were prepared by Mr. H. Elsmann.

Finally, I extend sincere thanks to my friends H. Enghoff, O. Jensen and E. Rald, who often brought home valuable material from excursions in Denmark, Sweden and Finland, and I owe them a debt of gratitude for valuable criticism of my work.

## Diagnosis of the Sphecidae

The Sphecidae constitutes a family within the Hymenoptera Aculeata, closely related to the bees. An autapomorphism for the Sphecidae is not expected to be existing since this family (or a subgroup within this) is regarded the more primitive of the two families, Sphecidae and Apidae (s. lat.), constituting the superfamily Sphecoidea (see also p. 33).

As the Sphecidae is impossible to define in terms of derived characters, the following combination of characters provides sufficient data for referring any Nordic specimen to this family:

Head orthognathous, i. e. mouthparts directed ventrally; eyes large, occupying most of the lateral and antero-lateral surfaces of the head; mandibles usual-

ly stout biting tools, often provided with strong teeth apically or internally; labio-maxillary complex usually short; antennae typically consisting of 13 segments in males and 12 in females; posterior margin of prothorax squarely truncate, in rare cases arcuate; scutum usually continuous with the dorsal part of mesopleuron, resulting in a wide separation of the posterior margin of the humeral tubercles and the tegulae; mesothorax ventrally and laterally represented by the very large mesopleuron; propodeum usually forming a large, strongly convex, sculptured sclerite, whereby thorax becomes rather elongate; abdomen (gaster) usually consisting of seven visible segments in males and six in females; first abdominal segment, or parts hereof, often considerably elongate and narrow, forming a petiolus; last tergum in females often with a triangular, margined area with heavier sculpture (pygidial area); forelegs in females typically with a strong tarsal pecten; claws dentate only in rare cases; forewings typically with three cubital and two discoidal cells, but in several cases these numbers are reduced.

## Morphology of adult Sphecidae

The general morphology of the adult Sphecidae is roughly similar to that of other Hymenoptera Aculeata. The following description is brief and only intended to elucidate the terms used in the keys and descriptions of genera and species.

HEAD (Figs. 1-3).

The head is large and very movable. A considerable large part of its surface is occupied by the compound eyes. These consist of a large number of ommatidia, whose size may vary considerably, even in an individual. Between the facets there are hair-like sensillae which in some species, e. g. *Entomognathus brevis*, may be visible with a pocket lens. Along the upper part of the orbit of the compound eyes many species have an elongate, either depressed or raised portion with different sculpture. This is called the facial fovea (fovea facialis) (Fig. 3). On the upper part of the vertex three ocelli are found, whose mutual position may be of great systematic value. In certain genera (e. g. *Tachysphex*) the two lateral (posterior) ocelli are highly divergent in appearance; they are depressed and elongate (Fig. 287).

Normally the antennae are inserted dorsal to the suture between clypeus and the lower part of the face (the epistomal suture) (Fig. 1). Their first segment is called the scape (scapus), the second, which is considerably smaller, the pedicel (pedicellus). The remaining part of the antenna is the flagellum. The antennae always consist of 12 "segments" in the females, and normally of 13 segments

in the males. Scapus is always the largest segment, and when this is relatively long, the antennae are said to be geniculate. Ventrally on the flagellum the males very often have a single or a pair of longitudinal pads (tyloidea) on each segment, whose morphology is often specifically distinct. The morphology of the flagellum, especially in the males, shows a considerable variation, since part of the segments may be excavated, depressed, dilated or provided with tooth-like processes.

The area between the anterior (median) ocellus and the epistomal suture is called frons (Fig. 1). Posteriorly on the head there is a large hole (foramen magnum) (Fig. 2), through which the internal organs (oesophagus, nerve cords etc.) pass from the head to the thorax. Round this hole runs, at a short distance, a carina (the postoccipital carina) (Fig. 2). Outside this there is a large horse-shoe-shaped area (occiput), which represents the posterior surface of the head. Laterally it is delimited by a usually sharp carina (the occipital carina) (Fig. 2). Anteriorly on the head, below the frons, a large plate, clypeus, is found (Fig. 1),

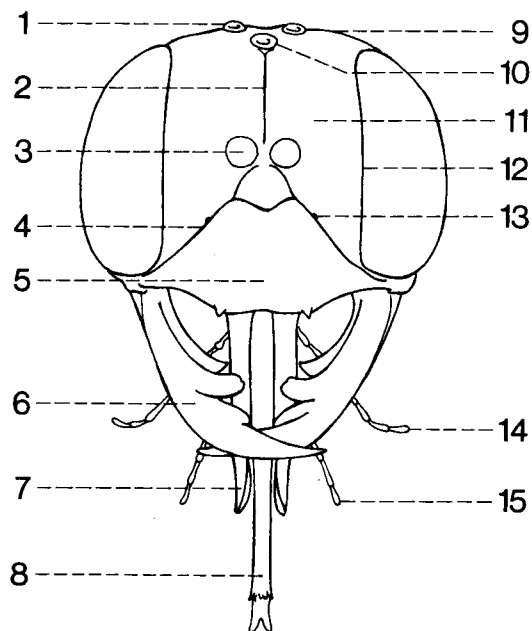

Fig. 1. Head of *Ammophila* sp. ♀ in frontal view. - 1: lateral ocellus; 2: frontal line; 3: antennal socket; 4: epistomal suture; 5: clypeus; 6: mandible; 7: galea; 8: glossa; 9: vertex; 10: anterior ocellus; 11: frons; 12: inner orbit; 13: anterior tentorial pit; 14: maxillary palpus; 15: labial palpus.

covering partly the mouth, partly the mandibles, when these are at rest. The anterior margin of the clypeus shows great variation, and this is frequently used in taxonomy. The labrum is articulated distally on the clypeus. Normally, the labrum is partly concealed by the clypeus, but in *Bembix* it is articulated with the anterior margin of the clypeus (Fig. 78). The mandibles are strongly developed, partly for biting, partly as digging tools. Their number of teeth, excavations etc. are useful taxonomic characters. Sexual dimorphism in the morphology of the mandibles is very common. Maxillae and labium are connected by membranes and function as a unity, the labio-maxillary complex, during intake of food. Generally the labio-maxillary complex is comparatively short in Sphecidae. A typical six-segmented maxillary palp is found in this family (Fig. 2). The labial palp (Fig. 2) normally consists of four segments.

THORAX (Figs. 4-5).

The thorax consists of three fused segments, however, the anterior segment

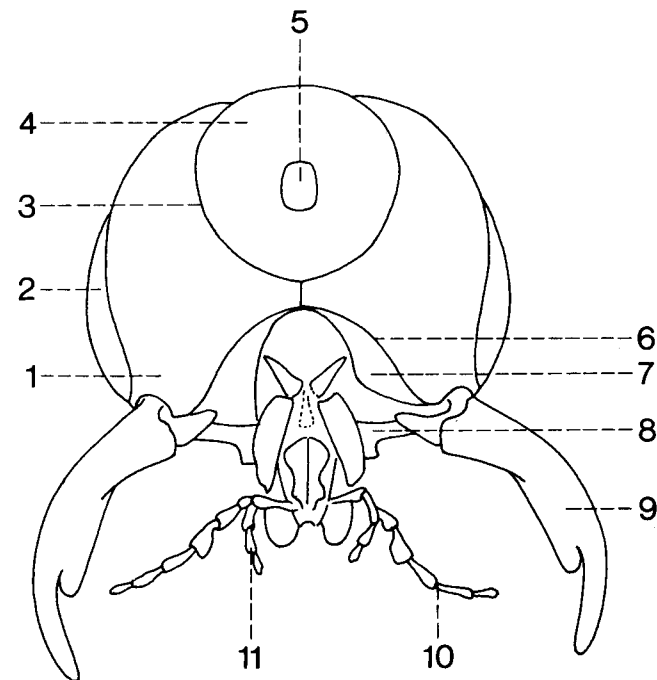

Fig. 2. Head of *Ammophila* sp. in posterior view. - 1: gena; 2: compound eye; 3: occipital carina; 4: occiput; 5: foramen magnum; 6: hypostomal carina; 7: hypostoma; 8: clypeus; 9: mandible; 10: maxillary palpus; 11: labial palpus (Redrawn from Bohart and Menke, 1975).

(prothorax) is ventrally rather loosely connected with the mesothorax. Prothorax is usually short (except in Sphecinae (Fig. 4), Ampulicinae and *Alysson*). Laterally it is protruded into a backward directed, sharply delimited lobe, the pronotal or humeral tubercle, which covers the mesothoracic spiracle (Fig. 4). The distance between the humeral tubercle and the base of the forewings is usually large so that the mesonotum achieves a broad contact with mesopleuron. Dorsally on the prothorax (pronotum) a sharp transverse carina is often present, which laterally may be protruded into tooth-like processes. The propleuron (pleuron 1) is rather loosely connected with the pronotum and appears as a segment belonging to the legs.

The mesothorax is by far the largest thoracic segment. Dorsally it is divided into two sclerites, scutum (Fig. 5) (mesoscutum) and scutellum (Fig. 5). On the scutum often one or several pairs of longitudinal furrows or carinae are found. Anteriorly are found two median scutal lines, and lateral to these run the pre-scutal carinae (Fig. 5). From the posterior margin of the scutum the parapsidal furrows run a shorter or longer distance forward. Often only a single pair of longitudinal lines is found lateral to the median scutal lines, and these are generally called parapsidal furrows, although this term is not strictly correct. A separate mesosternum is not found in Sphecidae, and the whole lateral and ventral part of the mesothorax is therefore usually called mesopleuron. The precoxal suture (Fig. 4) often protrudes sharply anterior to coxae 2, where it may develop as an angularly bent carina or be reduced to a small tooth-like process. The ventral midline is usually strongly depressed and is called the median sternal groove. From a sharp depression, just ventral to the base of the forewings

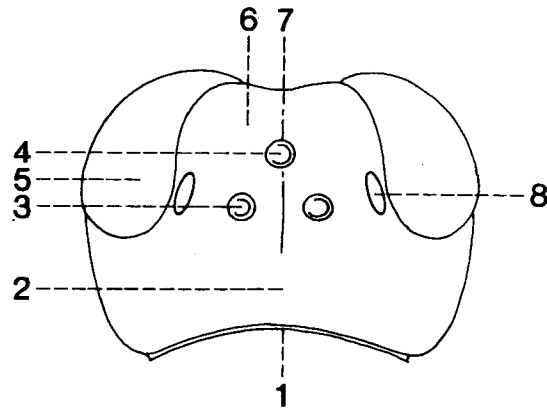

Fig. 3. Head of *Crossocerus* sp. in dorsal view. - 1: occipital carina; 2: vertex; 3: lateral ocellus; 4: anterior ocellus; 5: compound eye; 6: upper frons; 7: frontal line; 8: facial fovea.

(subalar pit), a coarsely pitted oblique furrow (anterior oblique furrow) often runs ventrally, where it may join or cross the epicnemial carina (Fig. 4). The area in front of the epicnemial carina is called the epicnemium (Fig. 4). In *Mimumesa* the epicnemial carina continues in the acetabular suture or crest (Fig. 75). The epicnemium is often smooth without sculpture.

The metathorax is short, dorsally represented by metanotum, laterally by metapleuron (Fig. 4). The sutures between scutum and scutellum are often strongly depressed, and may be divided into coarse, more or less quadrate pits.

#### ABDOMEN.

The first abdominal segment forms part of thorax as a functional portion of thorax, and is called propodeum. It is usually very large. Many species have dorsally a more or less heart-shaped area (area cordiformis or propodeal enclosure (Fig. 5)), whose sculpture often deviates considerably from that of the surrounding areas. The morphology of this area is of great taxonomic value, and its sculpture is extensively used in the definition of several species. In many genera the propodeum carries characteristic spines or teeth. Between the propodeum and the functional first abdominal segment a very pronounced constriction is found, whereby the abdomen becomes very mobile, mainly in the vertical plane. In the Sphecidae, usually the female abdomen consists of six visible segments,

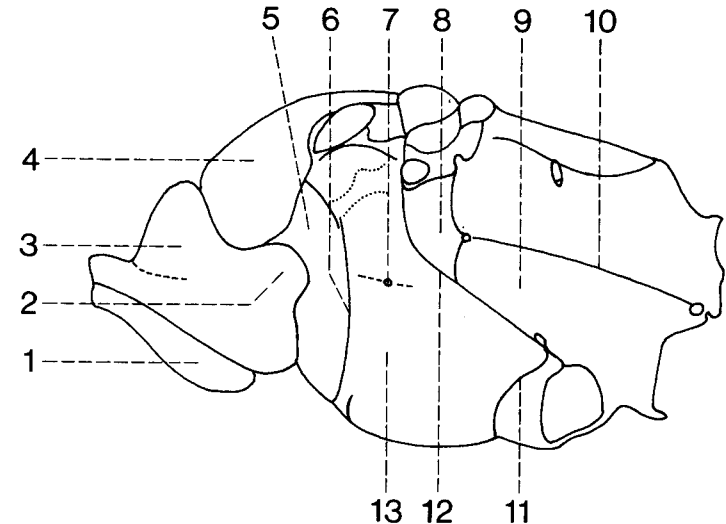

Fig. 4. Thorax and propodeum of *Ammophila* sp. in lateral view. - 1: propleuron; 2: humeral tubercle; 3: pronotum; 4: scutum; 5: epicnemium; 6: epicnemial carina or suture; 7: mesopleural scrobe; 8: upper metapleural area; 9: lower metapleural area; 10: metapleural suture; 11: precoxal carina or suture; 12: mesopleural suture; 13: mesopleuron (Redrawn from Bohart and Menke, 1975).

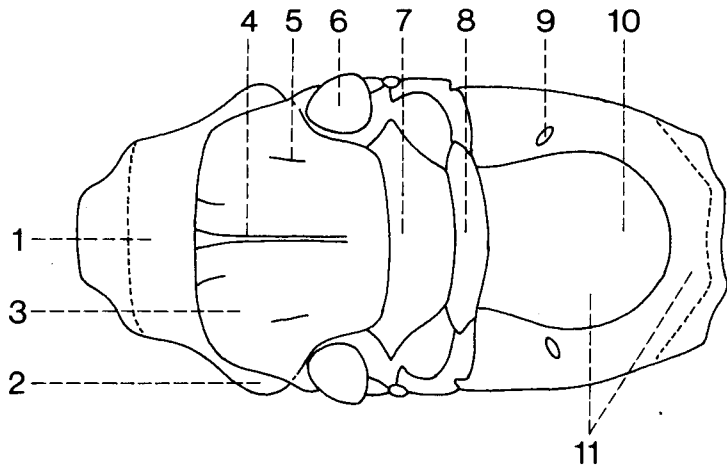

Fig. 5. Thorax and propodeum of *Ammophila* sp. in dorsal view. - 1: pronotum; 2: humeral tubercle; 3: scutum; 4: median scutal lines; 5: parapsidal furrow; 6: tegula; 7: scutellum; 8: metanotum; 9: propodeal spiracle; 10: dorsal propodeal area or area cordiformis; 11: propodeum (Redrawn from Bohart and Menke, 1975).

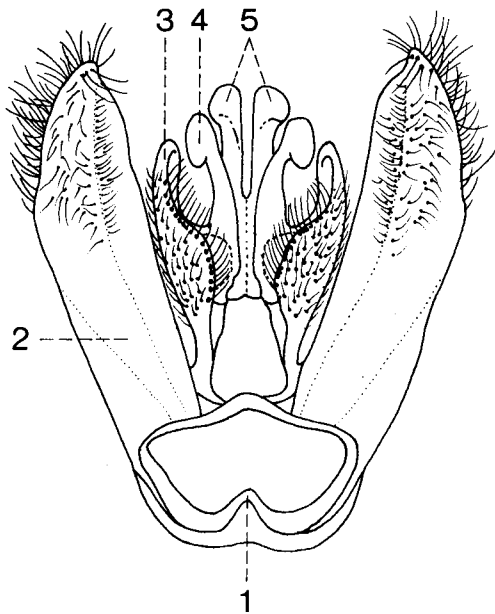

Fig. 6. Male genitalia of *Chlorion aerarium* Patton in ventral view. - 1: basal ring; 2: paramere; 3: cuspis; 4: digitus; 5: aedeagus (Redrawn from Bohart and Menke, 1963).

the male of seven. Segments VIII and IX are highly modified and form the sting apparatus etc. in the females, and the external genitalia in the males (see below). The anterior part of the abdomen may be considerably prolonged forming a petiolus, either by the first sternum alone or by first sternum + tergum. In the latter case it carries spiracles. On the last visible tergum in the females (VIth) a pygidial area is very often found, which usually is surrounded by a protruding carina. The morphology and pubescence of and round this area are very characteristic, and frequently used in taxonomy.

#### MALE GENITALIA (Figs. 6, 7).

The morphology of the external male genitalia is subject to great variation in the Sphecidae, and since, in some cases, they may be useful in the identification of closely related species, they are briefly described. The terms used in the following should be regarded as "trivial names" (cf. Snodgrass, 1941 and Smith, 1970). Proximally there is a ring-shaped sclerite (basal ring, gonobase, lamina annularis) (Fig. 6) with which some of the remaining sclerites are articulated. The large parameres (Figs. 6, 7), which morphologically are developed from gonocoxa and gonostylus, are situated laterally. These sclerites are, however, always fused, and the suture has disappeared. Medial to these, a proximal sclerite, volsella (lamina volsellaris) (Fig. 7) is typically present which distally carries the usually mutually movable cuspis and digitus (Fig. 6). In several species the volsellae are highly reduced and may be absent. Dorsally between the parameres the aedeagus (phallus) (Figs. 6, 7) is found, which is a paired structure, often with incisions, teeth etc., which may be used in taxonomy.

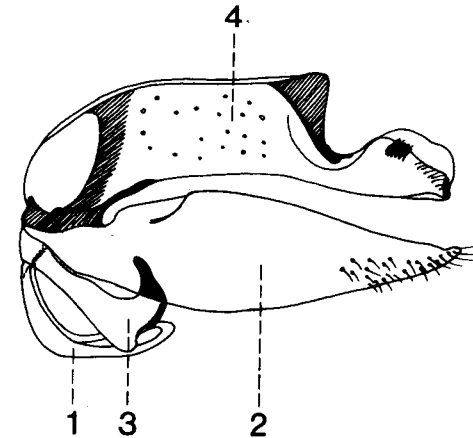

Fig. 7. Male genitalia of *Nitela borealis* Valkeila in lateral view. - 1: basal ring; 2: paramere; 3: volsella; 4: aedeagus.

## LEGS.

In principle the legs do not differ from normal legs in Hymenoptera Aculeata. In the females the forelegs are very often modified for digging, thus the tarsi on the outer side may carry a row of stout, usually deflexed spines (tarsal pecten). Proximally on metatarsus (basitarsus) of the forelegs there is a deep emargination, which together with the apical spur on the tibia forms an antenna cleaner. A similar, but more weakly developed device, is found on the hindlegs. The legs or parts of them are very conspicuously developed in many males, e.g. within Crabronini, in which especially the tibia 1 and tarsus 1 may be much flattened, dilated or of different colour from the rest of the leg. It is probable that these highly modified forelegs are used to seize the female during copulation.

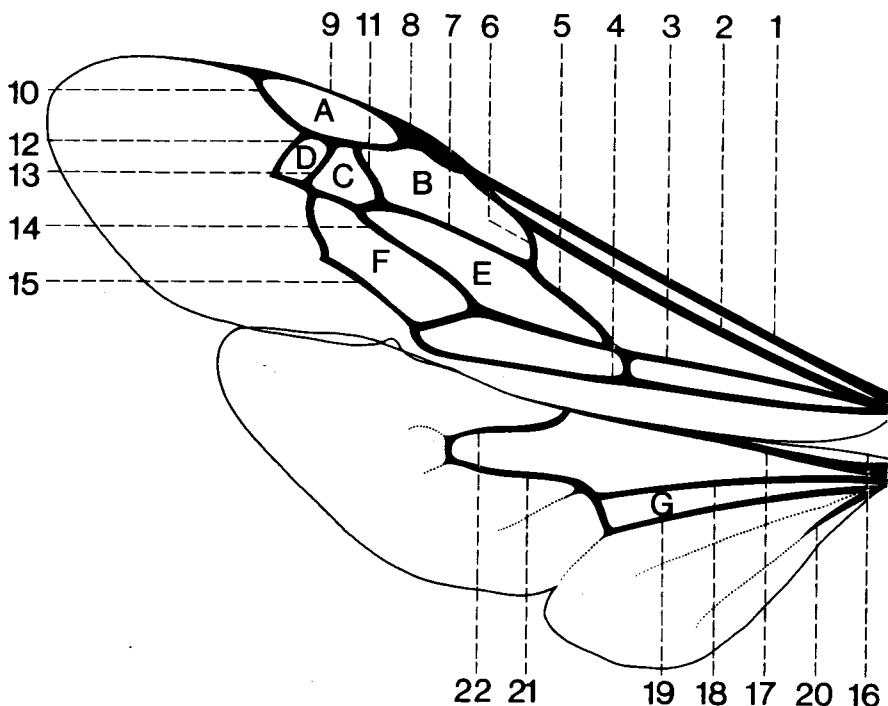

Fig. 8. Wings of *Ammophila sabulosa* (L.). - 1: costa + subcosta; 2: radius; 3: media + cubitus; 4: analis 1; 5: media; 6: radial sector; 7: radial sector + media; 8: pterostigma or stigma; 9: radius; 10 - 11: radial sector; 12: third cubital transverse vein; 13: second cubital transverse vein; 14: first discoidal transverse vein; 15: second discoidal transverse vein; 16: costa; 17: radius; 18: media + cubitus; 19: analis 1; 20: analis 3; 21: media; 22: radial sector. Cells: A: radial cell; B: first cubital cell; C: second cubital cell; D: third cubital cell; E: first discoidal cell; F: second discoidal cell; G: anal cell (Terminology adopted from Richards, 1956).

## WINGS (Fig. 8).

The venation is best illustrated by a drawing (Fig. 8). The fore- and hindwings are coupled during flight by means of a number of hooks (hamuli) on the anterior margin of the hindwings. The hooks catch on to part of the reflexed posterior margin of the forewings.

## Bionomics

The species of the Sphecidae are primarily solitary Hymenoptera. There are, however, important exceptions (see also Evans, 1964b): *Microstigmus comes* Krombein (Pemphredoninae) from Costa Rica shows "reproductive dominance" (division of labour) in females from the same nest. Apparently, no external morphological differentiation occurs (Matthews, 1968a, b). *Trigonopsis cameronii* Kohl (Sphecinae), occurring in Central and South America west of the Andes, shows a rather low degree of social development. Groups of females collaborate when constructing the nest. Theft without provocation of aggressive behaviour is common in this species (Eberhard, 1972).

In northern temperate zones adult Sphecidae are only active in the summer months, and the majority of the species produce only a single generation annually. The peak of the active period usually falls in June and July. Many species are, however, also on the wings during August and September, and a few may be met with in May. The maximum duration of life of the imagos is two to three months, dependent especially on climatic conditions.

The species frequently occur in habitats fully exposed to the sun, but a few, e.g. of *Crossocerus*, may breed in comparatively shady habitats such as woods. As to the placing of the nest, the Nordic Sphecidae may be divided into two main groups: (1) terrestrial species, which nest in the soil, and (2) arboreal species nesting in wood or hollow plant stems. The genus *Nysson* lives as predator on species of *Gorytes*, *Argogorytes* and *Dienoplus* (Nyssoninae), all of which construct their nests in the ground. It seems reasonable to assume that species belonging to group (1) represent the initial condition in evolution. In this connection it is interesting to note that both choices of habitat may exist within the same genus, e.g. *Lesticia* and *Crossocerus*, but only exceptionally within the same subgenus, e.g. *Crossocerus*. In certain species the same entrance is often used by several females, suggesting an initial social behaviour (examples: *Crossocerus elongatulus*, *C. megacephalus* and *Ectemnius cephalotes*).

In Northern Europe there is a tendency for the fauna gradually to include more arboreal species northwards, and if comparison is made with more southern fau-

nas, especially with the French, this tendency becomes clear. See also the chapter "Distribution and zoogeography".

A good classification of nest types was given by Merisuo (1943), which is summarized as follows:

A. Nests constructed in wood and the like.

I. Nests constructed by the wasp itself.

- a. In decayed wood, stumps etc. The system consists of a main tunnel and one to several lateral burrows. The cells are partitioned by sawdust..  
..... Ectemnius-type (Fig.9)
- b. In branches and thin stems. The tunnel system is branched or unbranched, the cells are arranged in a linear fashion. Partitions between cells consist of pith-dust or foreign substances .... Pemphredon-type (Fig.10)

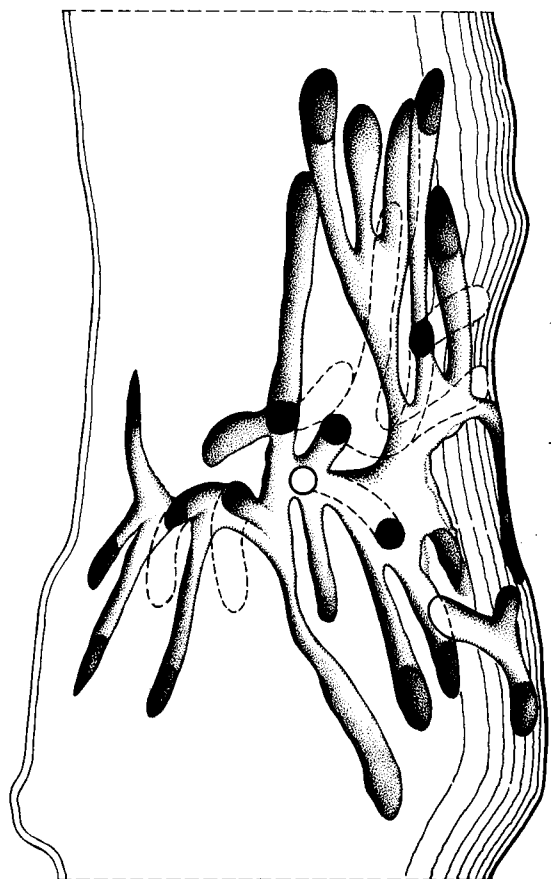

Fig.9. Nest of Ectemnius cephalotes (Oliv.) in trunk of Betula sp. Scale: 2 cm.

- II. Nest constructed in connection with tunnels made by xylophagous insects or old nests made by the same or other species of Sphecidae. Hollow plant stems are often used. The cells are arranged successively in branched or unbranched systems. The partitions between the cells consist of wood-dust or foreign substances ..... Passaloecus-type (Fig.11)

B. Nests constructed in soil.

I. A single cell.

- a. Containing one to five prey animals ..... Ammophila-type
- b. Containing many prey animals ..... Bembix-type

II. Branched tunnel system with mass provisioning in each cell.

- a. Cells placed in short lateral tunnels ..... Cerceris-type
- b. Cells placed in long lateral tunnels ..... Gorytes-type

Other classifications are given by Abrahamsen (1972), Crevecoeur (1951), Minikiewicz (1933), and Tetens Nielsen (1936).

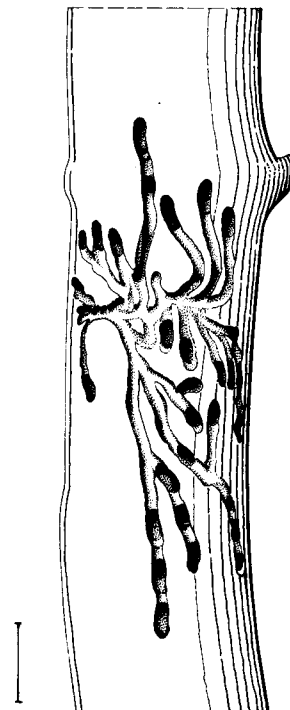

Fig. 10. Nest of Pemphredon lugubris (Fabr.) in branch of Quercus robur. Scale: 2 cm.

It is mentioned by Merisuo (l. c.) that the majority (about 75%) of the arboreal species in Finland are black or mainly dark coloured, while species constructing their nests in the ground usually have yellow and/or red markings (about 75%). Whether this is ascribable to camouflage seems rather uncertain.

Construction of the nest - as far as the terrestrial species are concerned - is mainly with the forelegs, whose tarsal segments usually bear a strong tarsal pecten on the outer side. A few genera (Dinetus, Podalonia and Belomicrus) have developed a psammophore, which consists of a row of long stiff hairs, partly on the inner side of femur 1 and partly along the ventral face of the head. When closed, these together constitute a kind of basket, in which material can be carried away. The mandibles play an important part in breaking up coarse-grained material. Arboreal species almost exclusively use the mandibles when constructing nests. The mandibles may be highly modified, e.g. in species of Passaloecus, which also use them for transporting and handling resin (Lomholdt, 1973).

The behaviour of the females in connection with the highly evolved care of the offspring may be divided into five main components:

#### A. Hunting

1. Search for prey.
2. Attack and paralyzation.
3. Transportation of prey to a temporary storing place.

#### B. Construction of nest.

1. Search for suitable nesting site.
2. Excavation (eventually interrupted by periods where the temporarily deposited prey is inspected).

#### C. Transportation of prey to the nest and deposition in cell.

1. Prey transported to nest.
2. Nest examined.
3. Prey pulled down into nest.

#### D. Oviposition.

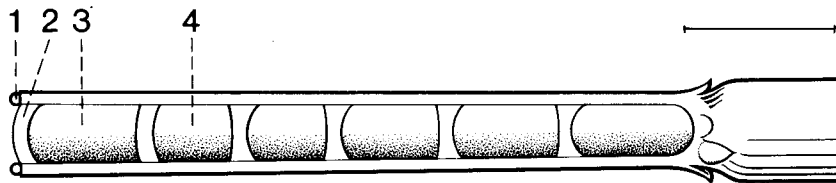

Fig. 11. Nest of Passaloecus eremita Kohl in stem of Phragmites communis. - 1: ring of resin droplets surrounding entrance; 2: terminal plug; 3: empty ves-tibular cell; 4: last provisioned cell. Scale: 1 cm.

#### E. Closing of nest.

1. Cell sealed.
2. Nest closed.

It is a general feature of the Sphecidae that the females undertake orientation flights in the immediate surroundings, both when a fully provisioned cell has been closed, and when the entrance is sealed. The above-mentioned schedule can be applied directly to the Ampulicinae and several Sphecinae, but should be modified if used for the description of the breeding biology of the "higher" Sphecidae. See the chapter "Phylogeny and Evolution".

The prey animals are mainly free-living insects and spiders, but several species of Podalonia seek terrestrial larvae of Noctuidae (Lepidoptera). The selection of prey shows that Diptera and Homoptera are preferred in Fennoscandia and Denmark. Usually the species seek their prey within a genus, order or suborder, but some species, e.g. Crossocerus quadrimaculatus and Lindeni-us albilabris use prey of several orders. Other species, e.g. Dolichurus cornicul-us, Philan-thus triangulum, Argogorytes mystaceus and Belomicrus borealis have specialized on a single prey species.

Searching for prey often takes place far from the nest. In single cases (Passa-loecus) the prey is sought in the same locality where the material for partitioning the cells is found. The prey consists of aphids living in pine and spruce.

In many species, especially those collecting Diptera, the large compound eyes play an important rôle in locating the prey. At short range (when the prey has been seized) the senses of smell and touch replace the vision. The species of Mellinus and Ectemnius are probably sharp-sighted at a distance of 15-20 cm. The hunting method of Mellinus can briefly be described as a slow stalking towards the prey to a distance of 2-3 cm. Thereupon the wasp seizes its prey with wide-open mandibles and spread forelegs. Ectemnius cavifrons and others, at the sight of a suitable prey, (often Syrphidae) will perform a hovering flight and make short jerky horizontal movements (estimate of distance), very slowly approaching the resting fly. With lightning speed it attacks the prey, seizes it with mandibles and legs, and paralyzes it. Such hunting technique is learned, and many unsuccessful attempts are made, before the technique is mastered. The adaptive radiation which has taken place with regard to the hunting methods within the Sphecidae has been briefly summarized in Table 2.

Paralyzation of prey is made almost exclusively by means of poison injected mainly ventrally in the thoracic region. The chemical composition of the poison is not known. In the honey bee it is produced in the acid gland, its active component being one or several neurotoxins (dialysable proteins) produced together with phosphatases and probably also acetylcholine and formic acid (Wigglesworth, 1965).

The products from the alkaline gland are not supposed to have toxic action. It is known that Philanthus triangulum is immune to its own poison (Rathmayer, 1962). Tetens Nielsen (1935) described the effect of the poison on larvae of Ceramica pisi L. (Lepidoptera, Noctuidae), which were paralyzed by Ammophila. He found that especially in the metathoracic ganglion, but also in the brain (supraoesophageal ganglion) considerable histological changes had occurred (evidence of degeneration). The nuclei were dissolved and the nerve tissue on the whole badly injured. Rathmayer mentions that in Apis mellifera paralyzed by Philanthus triangulum, especially the glia-cells in the thoracic ganglions were strongly affected. Sphecidae using highly sclerotized prey, e.g. Cerceris, Philanthus and Lin-denius, inject the poison through the thin intersegmental membranes, especially near the base of the legs and through the cervical membrane, the poison thus coming in direct contact with the powerful leg and wing musculature, where it probably acts on the neuromuscular synapses. In Pemphredoninae the sting - as far as known - is not used during paralyzation. On the other hand, the preyed aphids receive a number of strong bites (malaxation) in the neck region. This causes paralyzation of the locomotory musculature.

Depending on the size of the prey, this is dragged or flown to the nest (Table 2). Species using relatively small-sized prey have to collect an often considerable number, and Pemphredon lugubris provides with up to 40 aphids per cell.

The most common method to bring home paralyzed prey is to hold it with the middle legs during the flight. Thereby the forelegs are free and can be used to reopen the temporarily closed entrance to the terrestrial nesting site. Pemphredoninae, which are mainly arboreal species, transport their prey held with the mandibles, and Oxybelus carries it impaled on the sting. There is a single observation showing that the latter method may also be used by Crossocerus elongatulus (Tetens Nielsen, 1933).

The egg is attached ventrally on the thorax of the prey so that the newly hatched larva has no difficulty in finding its way through the soft segmental membranes at the base of wings, legs and head. The egg is usually placed on the last deposited prey, whereafter the nest (cell) is sealed.

Since males of Sphecidae, like many other Hymenoptera, are haploid, i.e. arise from the unfertilized eggs (haploid arrhenotoky or generative parthenogenesis), the females must be able to control fertilization of the eggs.

In the honey bee this control is made by means of four pairs of small muscles placed near the origin of the spermathecal duct near the receptaculum seminis (Snodgrass, 1956). The haploidy of the males means that they cannot be bearers of recessive genes, and a consequence of this is that a favourably mutated gene will have a considerable chance to spread in species with generative parthenogenesis (Suomalainen, 1962). Another consequence of haploidy is that the males

cannot receive hereditary characters from their father, since they do not have one! (See also Whiting, 1945).

In species which construct their cells in a row, the innermost cell is first provisioned. In this cell is usually deposited a fertilized egg, which develops into a female. Dependent on the number and volume of the cells, fertilized and non-fertilized eggs are laid so that males develop in the outermost and often smallest cells. The eggs hatch in the course of one to three days and larval development normally takes two to three weeks. A cocoon is then spun and in this the larva hibernates. The pupal stage normally lasts two or three weeks. In the solitary Hymenoptera Aculeata it is very common that the males emerge earlier than the female. This is erroneously named proterandry. This is obviously necessary, since it would be a catastrophe if a newly hatched female from one of the innermost cells began to gnaw her way through the row of still un-reared pupae.

Males of Sphecidae play a biologically important, though very brief, rôle, since their primary function is to inseminate the females. This occurs probably only once. Repeated copulation attempts often occur, but once the female is inseminated, she is completely unresponsive to further approaches. The males do not partake either in the hunting of prey or the construction of the nest.

#### ECOLOGICAL SIGNIFICANCE.

Most species of Sphecidae in the North do not occur in large populations, and even if rather large local aggregations are found, their relative importance in terrestrial ecosystems has never been studied in detail. It should, however, be remembered that Philanthus triangulum is completely dependent on Apis mellifera (the honey bee) as prey, and might act as a rather severe predator on this species, but such cases are rather exceptional. Otherwise it is hard to imagine which biotic factors could affect the populations of the species of Sphecidae to any considerable extent. The relatively non-prey-specific habits may be responsible for the high adaptiveness observed in several species.

It might be claimed that e.g. Cerceris and species of Passaloecus and Pemphredon might have some positive economic importance by preying on harmful species of Curculionidae (Coleoptera) and Aphididae (Homoptera), respectively, but the influence has never been investigated. It is my impression that Cerceris arenaria, when preying on Hylobius or Pissodes and occurring in large aggregations, may have a clear decimating effect on the weevil populations, but that any species of Passaloecus or Pemphredon might be useful in the biological control of noxious aphids is hardly credible, especially in the Nordic countries, where the wasps usually produce a single, short-living generation which most likely is not synchronized to the life cycle of any given aphid species.



The Sphecidae themselves of course are preyed upon, and predators are found even within the family itself (Nysson). It seems that mainly preimaginal stages are affected, and that predators are mainly composed of Hymenoptera and Diptera. The predatory stress is only elucidated in a few instances (Danks, 1971; Lomholdt, 1973). The value of Sphecidae as pollinators is undoubtedly insignificant, but exceptions exist in Argogorytes and Gorytes, but only in areas where the Fly Orchid, Ophrys insectifera, is common. The extreme adaptations found in these species as to "tempt" their pollinators is a reflection of Nature's most astonishing fancy (Kullenberg, 1961).

#### PREDATORS.

The carnivorous insects from which the Sphecidae suffer in their preimaginal stages, are commonly called parasites. This term should, however, be reserved for organisms which during their ontogenetic development are dependent at the cost of other organisms, without killing these. The insect larvae which can be found in nests of Sphecidae can live either (A) on the available provision, with the result that the "host larva" dies from starvation, or (B) on the whole content of the cell (egg plus provision), or (C) exclusively on the full-grown larva or pupa. These "foreign" insects should be grouped under the term parasitoids or cleptoparasites, of which the first term (Malyshev, 1968) is preferable. The group can be divided into four biological types:

I. Inquilines: The egg is laid on or near the "host egg". It hatches rapidly, and the young larva seeks and devours first the "host egg", then the provision. Gasteruption (Evanidae) and some Chrysididae belong to this group.

II. Metaparasites: The "host larva" gets time to pass through parts of or the whole larval period, before it is attacked by the predator. Many Chrysididae, Chalcidoidea and Ichneumonidae belong to this group. The intraspecific size variation is often great in these species.

III. Orthoparasites: The predator does not lay its egg in the cell until the "host larva" has pupated. Some Chrysididae and Mutillidae belong to this group.

IV. Cleptoparasites: The larva feed exclusively on the provision. To these belong species of Diptera.

In the Coleoptera only a single predator, Megatoma undata L. (Dermestidae), has been established, the larva normally destroying several cells (Lomholdt, 1973).

The insect predators associated with the Sphecidae and other solitary Hymenoptera Aculeata seem to be host-specific only to a slight extent. However, a pronounced tendency exists in Hymenoptera "Parasitica" to seek Sphecidae nesting in wood, while the predatory Diptera seem to have specialized to a very great extent on terrestrial species. Within the Chrysididae, especially Omalus is a pre-

dominant predator on arboreal species, while Hedychrum and Hedychridium exclusively "parasitize" terrestrial species. In the Diptera the Sarcophagidae is the dominating predator group on Sphecidae nesting in the soil.

As predators should finally be mentioned birds, especially tits (Paridae) and woodpeckers (Picidae), which among other things feed on immature stages of arboreal Sphecidae.

## Distribution and zoogeography

The digger wasp fauna in Fennoscandia and Denmark cannot be said to represent a unity. All the species occurring within this about 1.25 mill. sq. km large area are supposed to have their main distribution outside this. It is true that a few species were hitherto described as endemic, but they must be supposed also to occur, for instance, in West Russia, possibly in the Urals or Caucasus. The 171 species which at present can be reckoned to belong to the Nordic fauna have had extremely varied opportunities to colonize this in many respects "inhospitable" territory. If the numbers of species in the northern countries are compared (Table 1), it is clearly seen that areas with a stable, warm and dry climate in the summer months harbour a richer fauna, whereas areas with a rainy and cool summer climate have a numerically much poorer fauna.

The family Sphecidae mainly inhabits tropical and subtropical climates and is especially abundant in arid and semiarid areas. In the deserts and semi-deserts of the Tropics also occur the most "primitive" forms, both in morphological and biological respects. Towards the north the number of species decreases very considerably. In the Mediterranean subregion probably around 400 species occur, and Table 1 shows the rapid decline in the number of species towards the north. It should, however, be pointed out that (1) The relatively high number of species in Sweden and Finland should be correlated with the presence of a more stable continental climate in the summer, which favours immigration of both eastern and southern faunal elements. Several species with an eastern distribution have arboreal nesting habits and are associated with the trans-Siberian coniferous zone - the Taiga. This continues through North America, which makes the existence of Holarctic species possible. Southern and southeastern species often have terrestrial nesting habits but many are associated with the deciduous forest. (2) The number of species in Norway, especially in the western areas, is strikingly low. Here the influence of oceanic climatic conditions must be regarded as a serious limiting factor. Unstable breeding conditions mean diminished reproduction and thereby reduced chances of survival in these areas.

TABLE 1.

Distribution of number of species in the North and adjacent areas.

Area	Number of species	% of arboreal species
France	292	28
Schleswig-Holstein	136	43
England	114	47
Denmark	123	48
Sweden	148	51
Norway	94	52
Finland	146	47
Karelia	120	43
Faunistic provinces of		
1 Fennoscandia and Den-	155	48
mark. See Fig.13.	153	37
2	122	50
3	27	41
4	47	40
5	72	50
6	9	79
7		

## COMPOSITION AND DISTRIBUTION OF SPECIES.

An analysis of the fauna composition of the Sphecidae in the North was given by Lomholdt (1974), and here only the main features are mentioned. Fig.12 shows how the number of species gradually declines towards the north and northwest through Fennoscandia. It is noted that there are large areas with strikingly low numbers of species, but this can probably be partly ascribed to low collecting activity. If distribution maps of several species are compared, faunistic provinces can be prepared (Fig.13), but an analysis of whether these provinces denote communities (associations) gives the result (Fig.14) that discontinuity does not exist between the regions. The fauna simply thins out gradually northwards. In describing the distribution of individual species, the provinces may, however, be useful, since they are also characterized on the basis of vegetation and climate.

## ARBOREAL FORMS.

As a matter of fact, the family Sphecidae should be regarded as having developed from terrestrial forms, and consequently arboreal nesting habits can be conceived as an advanced feature. This has very often induced modifications in the body parts involved in constructing the nest. Another characteristic trait in the arbore-

al forms is their often comparatively small size and absence of yellow and red colour markings (Merisuo, 1943).

No less than 48% (82 species) of the species in Fennoscandia and Denmark occur also in easternmost Asia (Mongolia, China, Kamtchatka, Sakhalin), and most of these (62 species) are found also in Japan. 56% (46 species) have arboreal habits, and of these 72% (33 species) can be characterized as true Taiga species, either found breeding mainly in conifers and/or using coniferous resin as nest-building material. The majority of these species belong to Siberian fauna elements, and in Fennoscandia they have a pronounced eastern or north-eastern distribution (Fig.15). Only a few of these species have been found in Denmark. A very considerable part (84%) of the total of 20 species with holarctic distribution are arboreal, but their distribution is often markedly disjunct.

## TERRESTRIAL FORMS.

In Fennoscandia and Denmark the terrestrial Sphecidae mainly represent south-

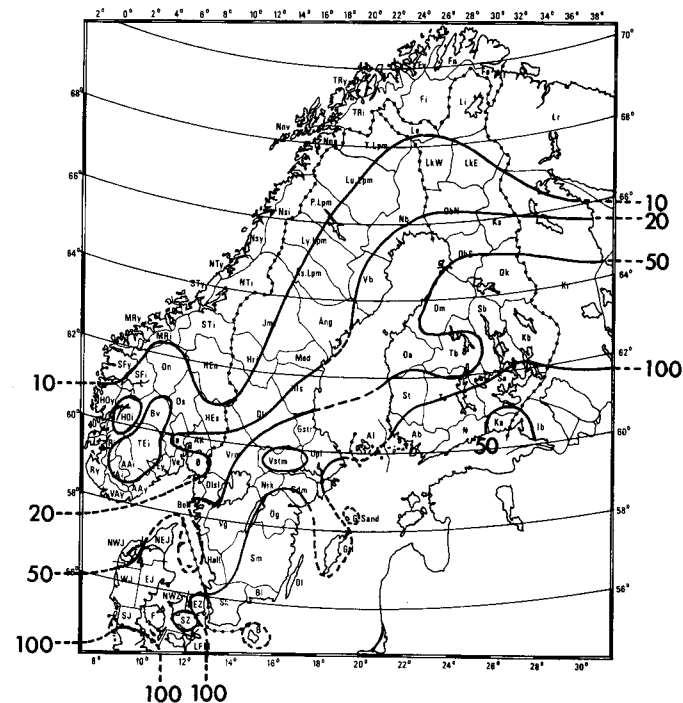

Fig.12. Isopories for the approximate numbers of sphecid species in Fennoscandia and Denmark. Unexpectedly low numbers of species - probably due to low collecting activity - are found in SZ, B, Vstm., Oa and Tb.

ern fauna elements. On basis of recent works, especially those by Kazenas (1972), Gussakovski (1952) and Tsuneki (1971a, b; 1972a, b) it can be established that several of the terrestrial species are widely distributed throughout the steppe and desert areas of Asia. However, they rarely reach the far east as the arboreal species. The sub-Taigan species have their main occurrence in the area between the distribution-area of the terrestrial and the arboreal species in Asia. To this group belong a large number of species breeding in deciduous trees and hollow plant stems.

The majority of the terrestrial species in Fennoscandia and Denmark have their origin in the Mediterranean region, but a number of them has undoubtedly spread from eastern eremial centres. On basis of the - admittedly rather fragmentary - information on the fauna composition through southern Siberia it is difficult to give a definite statement on the distribution centres of a large number of species. Many arboreal sub-Taigan species have a pronounced disjunct occurrence, partly occurring in Europe, partly in East Asia. In many cases this may be explained by the absence of deciduous forest in large areas of Central Asia.

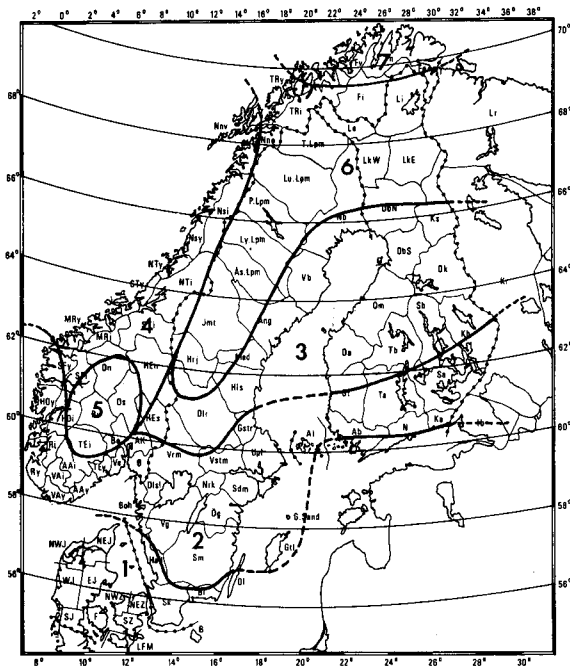

Fig. 13. Faunal provinces in Fennoscandia and Denmark constructed on the basis of the distribution pattern of Sphecidae.

The distribution pattern of the terrestrial sub-Taigan species also is often disjunct in Asia, but this may be ascribable to the often scattered collecting. That the arboreal species, in contrast to the terrestrial sub-Taigan ones, often have developed subspecies in Europe and East Asia respectively may be the expression of effective isolation of the two populations.

#### EXAMPLES OF DISTRIBUTION TYPES IN FENNOSCANDIA AND DENMARK.

Mediterranean fauna elements represent the main part of the fauna and constitutes 64-81% of the species in fauna provinces 1-6, but only 55% in fauna province 7.

As could be expected, this share is largest in the southern and western provinces and smallest in the northern and eastern. The distribution of the Mediterranean species in the North can be divided into two types, of which one comprises pronounced expansive species, which may occur north of the Gulf of Bothnia (Fig. 16). The other type comprises species which have their northernmost occurrence in Denmark, southernmost Sweden and Finland, and possibly in extreme south-eastern Norway (Fig. 17).

The influence of Siberian (eastern) fauna elements is, as said above, mainly found in the boreal coniferous forest in Finland and Central Sweden (Fig. 18). To this type belong also species, whose southern distribution limit runs through Fennoscandia. These northern boreal species often have a disjunct boreo-mon-

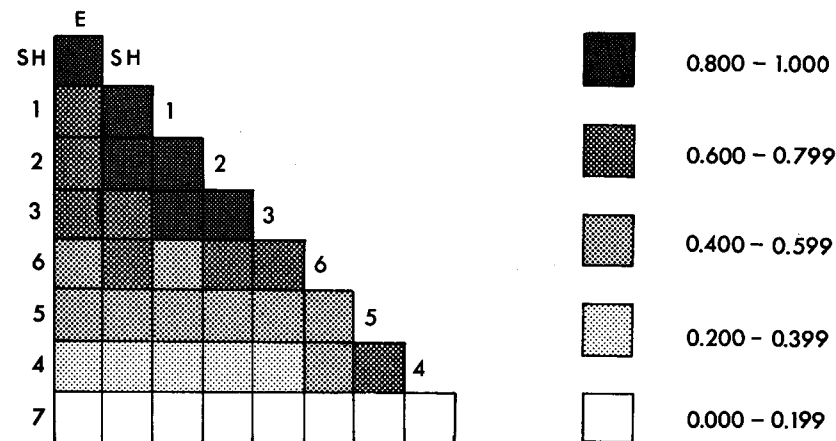

Fig. 14. Using Sørensen's quotient of similarity ( $QS = 2c/a+b$ , where a = no. of species in the larger fauna, b = no. of species in the lesser fauna, and c = no. of common species in a and b), a Trellis diagram is constructed. The seven faunal provinces (Fig. 13) are compared mutually and with adjacent areas. No discontinuities are found, i. e. distinct associations probably do not exist. E=England, SH=Schleswig-Holstein.

tane (-alpine) distribution in Europe. Table 1 also shows that the influence of the arboreal species is relatively great in the provinces 3, 6, and 7.

In the Fennoscandian and Danish faunas - as said above - many species occur, whose distributional patterns may be difficult to explain. Several of these species are rare, and certain of them are only known from very few specimens. Pemphredon fennicus is hitherto only known from the two type-specimens (female + male) from the north boreal coniferous zone in Finland and Sweden. The species is interesting for its pronounced deviation from all palaeartic species of Pemphredon, but it exhibits considerable morphological affinity to the North American P. nearcticus. Of the remaining, apparently endemic species, should be mentioned Belomicrus borealis, Spilomena exspectata, S. curruca and Crossocerus lundbladi, Sphex rufocinctus, Tachysphex fulvitaris, Crossocerus imitans and Podalonia luffii all have a very isolated occurrence in Fennoscandia and Denmark and might be regarded as postglacial thermophilous relics.

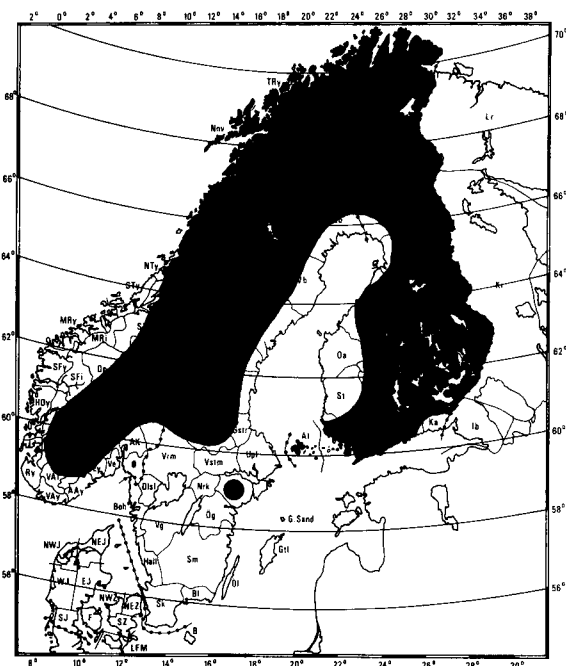

Fig. 15. The distribution of Crabro lapponicus Zett. in Fennoscandia. The species has a boreo-montane disjunct distribution in Europe.

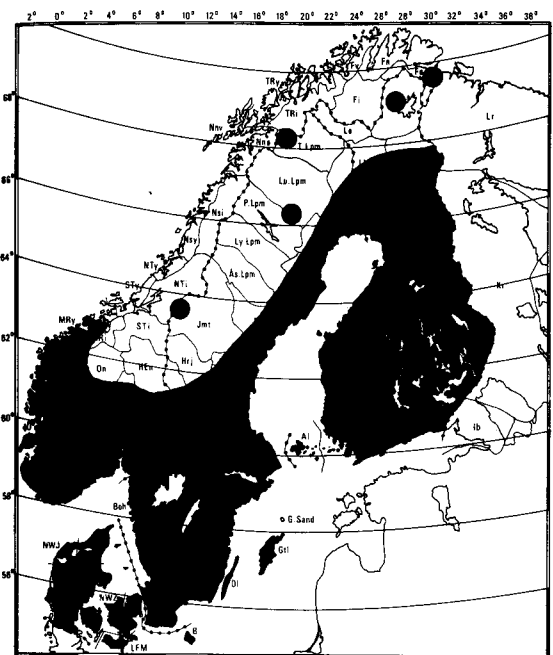

Fig. 16. The distribution of Ectemnius continuus (Fabr.) in Fennoscandia and Denmark. A holarctic species.

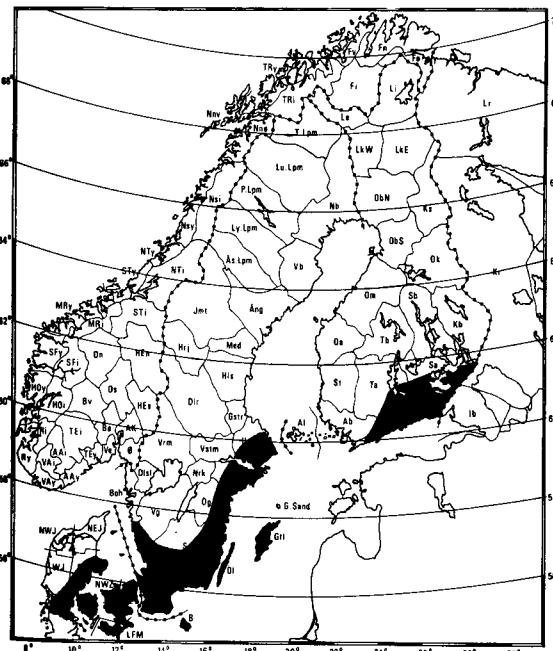

Fig. 17. The distribution of Philanthus triangulum (Fabr.) in Fennoscandia and Denmark. An example of a pronounced southern distribution.

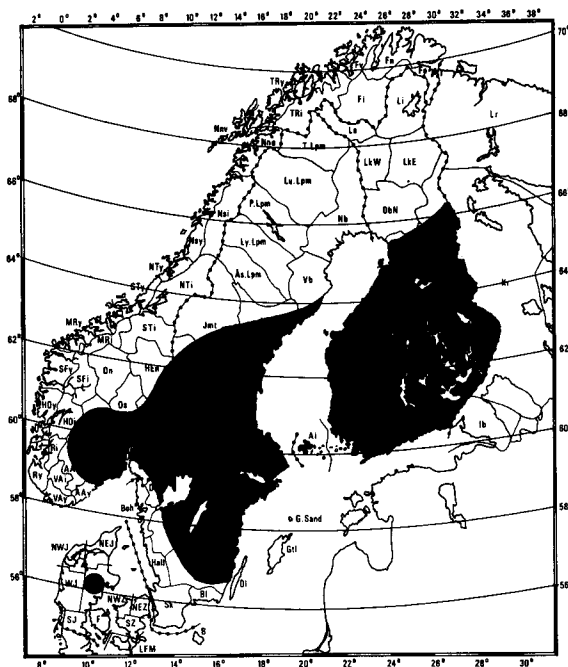

Fig. 18. The distribution of *Diodontus medius* Dahlb. in Fennoscandia and Denmark. A Siberian (eastern) species.

## Phylogeny and evolution

The group Hymenoptera Aculeata forms part of the Hymenopteran suborder Apocrita. In the aculeate Hymenoptera the ovipositor is modified into a sting, having thereby lost its function in connection with oviposition. The aculeate superfamilies are as follows: Scolioidae, Bethyloidea, Formicoidea, Vespoidea, Pompiloidea and Sphecoidea.

Oeser (1961) mentions the following synapomorphic characters of the ovipositor of the Aculeata:

1. The presence of an incisura postarticularis (a deep incision proximally on 2nd valvifer). This is secondarily reduced in the Chrysididae (Bethyloidea).
2. The presence of a "furcula", a small V- or Y-shaped sclerite, situated dorsal to the 2nd valvulae. This is also called "detached notum" (Smith in Tuxen, 1970).

On this basis the Hymenoptera Aculeata should be regarded as a monophyletic unit. This view is also supported by Malyshev (1968), who discussed the phylogeny on the background of biological criteria, and Alten (1910), who elucidated phylogeny on the basis of the development of the central nervous system. Telen-

ga (1969) discussed the evolution of the Hymenoptera Aculeata on characters in the venation, thereby arriving at a diphyletic origin of the group. The Chrysididae are thus supposed to be derived from an evanioid ancestor, while the other Aculeata are proposed to have an ichneumonoid ancestor. This view is, however, not considered sufficiently founded to be accepted.

The Sphecoidea is here considered to include the Sphecidae and the Apidae (s. lat.) (Michener, 1944). The Apidae (s. lat.) represents a highly specialized subgroup and their close relationship with the Sphecidae would be considerably obscured, if the bees were placed in a separate superfamily. On p. 36 the most important diagnostic characters separating the Sphecidae and Apidae (s. lat.) are listed. It appears that these characters occur in their plesiomorphic state in the Sphecidae. The apomorphic conditions found in the Apidae (s. lat.) are often associated with the collecting of pollen and nectar. Virtually, all the 36 characters by Michener (l. c.) stated as primitive in the Apidae (s. lat.) are found in the same condition in the least specialized Sphecidae. Convergenly evolved reductions occur in both groups, e. g. with regard to number of segments in the maxillary and labial palps, the number of cubital and discoidal cells in the forewing, the morphology of the volsella and the loss of the proximal tooth on the claws.

The family Sphecidae is here considered as comprising the following subfamilies: Ampulicinae, Sphecinae, Pemphredoninae, Astatinae, Philanthinae, Nyssoninae, Mellininae, and Larrinae.

The Ampulicinae and Sphecinae should be regarded as comprising the least specialized Sphecidae, not only as regards the morphology of the larvae (Evans, 1956, 1959a, 1959b) and the imagines, but also with regard to the ethology of the breeding biology (Table 2). In the least specialized subfamilies, i. e. the two previously mentioned, plus some Pemphredoninae, the volsellae carry a very well developed cuspis and digitus, and are usually large, isolated sclerites, which, however, may be mutually connected by a ventral sclerotized bridge (Snodgrass, 1941). The cuspis is often smaller than the digitus and may be absent, especially in very small species, or may be much reduced.

Within the more specialized Sphecidae there is a pronounced tendency to develop very large eyes. Concomitantly a differentiation of the size of the ommatida takes place so that those directed forwards become many times larger than those of the dorsal part of the compound eye. This phenomenon is especially pronounced in the Crabronini (Larrinae), and is probably related to the extra visual powers required to hunt fast-moving Diptera.

The evolution of the brood care within the Sphecidae can be divided into several phases as appears in the following scheme (slightly modified after Malyshev (1968)):

Evolutionary phases	Formula of brood care	Examples
I. Pompiloid phase	n (A+B+C+D+E)	<u>Podalonia</u> , <u>Sphex</u>
II. Sphecoid phase	n (B+A+C+D+E)	<u>Dolichurus</u> , <u>A. sabulosa</u>
III. Crabronoid phase	B+(AC) n+D+E	<u>A. pubescens</u>
IV. Bembicoid phase	B+AC+D+((AC) n) t+E	<u>Philanthus</u> , <u>Bembix</u>
V. Moneduloid phase	B+D+((AC)n)+E	<u>Monedula</u> (non-European)

A: hunting; B: construction of nest; C: transportation of prey; D: oviposition; E: closing of nest; n: number of prey; t: number of days for provisioning after oviposition.

It seems evident that there must be, and still exist, selective pressure towards development of forms which excavate the nest before hunting. This is obvious, because there is considerable risk that the paralyzed prey may be robbed by other predators during excavation of the nest. It is also characteristic that the species in groups I and II provision their nests with only a single or very few prey animals. These are so large that they cannot be flown, but must be dragged or carried the often long way to the nest. On the way the risk of attack is naturally greater than if they were transported by air (Table 2).

The delimitation and definition of the subfamilies Ampulicinae, Sphecinae, Pemphredoninae, Philanthinae and Mellininae is not difficult. Within the Larrinae the diversity of external morphology of the imagines is overwhelming compared with conditions within the other larger subfamilies, but a synapomorphism in this group, very specialized in several respects, is difficult to find. The presence of an oblique, sharp and very well defined crista on coxa 2 might be interpreted in this way. In several genera a remarkable character is developed in the mandibles, viz., a broad, often semi-circular emargination in the ventral margin, proximally delimited by a tooth of varying size. The presence of this character does not, however, seem to be restricted to the Larrinae, since similar structures are often found in males of Astata (Astatinae), although not nearly as distinct. In the Philanthinae, Mellininae and several Nyssoninae there is a broad concavity on the ventral margin of the mandibles, and it is questionable, therefore, whether this character should be regarded as synapomorphic of these groups. The species which excavate their tunnel systems in wood often have very broad and highly modified mandibles, often ending in a number of short, strong teeth (Pemphredon (Pemphredoninae) and Ectemnius (Larrinae)). In these the proximal concavity is absent. The Astatinae might perhaps be included as an inferior subgroup of the Larrinae, but the absence of the crista on coxa 2 is evidence to the contrary.

The loss of one spur on tibia 2 has taken place independently at least twice (in the Pemphredoninae and the Larrinae).

TABLE 2. Evolutionary trends in hunting and transporting prey in Sphecidae. (Partly after Evans, 1963).

Initial conditions as found in Ampulicinae and Sphecinae.	Derived conditions	Examples
Relatively prey-specific	Highly prey-specific Non-prey-specific	<u>Philanthus</u> <u>Crossocerus</u>
Prey larger than wasp	Prey smaller than wasp	Most sphecid genera
Prey caught close to nest	Prey caught in highly varying distance from nest	Most sphecid genera
Prey dragged on the ground held with mandibles	Prey flown to nest held with mandibles Prey flown to nest held with mid legs Prey flown to nest impaled on sting	Pemphredoninae Most Nyssoninae <u>Oxybelus</u>

The presence of a sometimes very strongly V- or U-shaped incision in the inner orbits of the Trypoxylonini (Larrinae) and Philanthus (Philanthinae) should not be overestimated, since this character was probably evolved convergently within the two subfamilies. The significance of this incision remains problematic. In Philanthus and certain species of Trypoxylon the ommatids ventral to the incision are considerably larger than those dorsal to it. But as mentioned above, a strong differentiation of the size of the ommatids is seen, especially in the Crabronini, where there is no incision in the orbita.

Maintenance of the Nyssoninae as a monophyletic group is problematic, since the characters used in the definition seem to occur in their plesiomorphic condition (Beaumont, 1954).

The variation in venation, especially in the forewings, is very considerable and cannot be used in a classification at subfamily level (Kohl, 1896; Arnold, 1923). Primarily three cubital cells and two discoidal cells seem to be present, but particularly in small species, a considerable reduction of their number has taken place. Especially in the Astatinae and Mellininae a secondarily evolved division of the first cubital cell by a very faint vein has occurred.

#### RELATIVE AGE OF THE SPHECIDAE

It is probable that the phyletic line giving rise to the Sphecidae also lead to the Apidae (s.lat.) (Evans, 1958). The problem remains, whether a sister-group

relationship exists between the two entities or whether the family Sphecidae is to be regarded paraphyletic in terms of the Apidae (s.lat.). The origin of the Apidae (s.lat.) is probably correlated with the appearance of the Angiospermae, which apparently took place in Upper Cretaceous; the question remains open, however, whether the Bennettitales, which became extinct at the end of the Lower Cretaceous, had developed flowers which were pollinated by insects (Gothan and Weyland, 1964).

It was pointed out by Malyshev (1968) that striking similarities exist both in the construction of the nest and in the egg-laying behaviour between the primitive apid genera Prosopis and Colletes (Colletidae sensu Michener) and Psenu-lus (Pemphredoninae). In these genera the inside of the cells are lined with a pellicula, a parchment-like coating secreted as a fluid from the mandibular glands. The egg is placed directly on the collected provision. The ability to produce a pellicula may well be evolved convergently, but the placing of the egg must be interpreted as a symplesiomorphism. Nesting behaviour in most solitary bees is very similar to that of the Sphecidae, and it seems most convincing to accept that the bees were primarily soil-nesting insects.

Turning to the fossil record the following sphecid fossils have been described: Archisphex Evans, 1969 and Taimyrisphex Evans, 1973 from Neocomian, Lower Cretaceous and Conician-Santonian, Upper Cretaceous, respectively, do not contribute to the understanding of the phyletics since they seem to be too generalized to be classified as true Sphecidae. They might even be interpreted as scolioid or pompiloid wasps (Evans, 1973). Lisponema Evans, 1973 and Pittoecus Evans, 1973 both occur in the same geological formation as Taimyrisphex but are characterized as rather specialized Pemphredoninae. Judging from Lisponema and Pittoecus which are supposed to be wood-nesting, the Sphecidae underwent considerable evolution before the end of the Cretaceous, and perhaps the origin of the Sphecidae should be traced backwards to the Jurassic.

#### LIST OF DIAGNOSTIC CHARACTERS SEPARATING SPHECIDAE AND APIDAE (s.lat.)

	Sphecidae	Apidae (s.lat.)
Imagines	Body slightly hairy.	Body usually very hairy.
	Hairs simple.	Hairs, at least on humeral tubercle, plumose.
	Metatarsus 3 cylindrical.	Metatarsus 3 compressed.
	Metatarsus 1 in female often provided with a tarsal pecten.	Metatarsus 1 in female simple, without tarsal pecten.

Labrum thin, often disc-shaped, without sculpture or pubescence.	Labrum thick, heavily sclerotised, often with strong sculpture and pubescence.
--	--

Clypeus with anterior duplicature that covers labral articulation.	Clypeus without duplicature, labral articulation visible.
--	---

Females collect animal provision.	Females collect vegetable food for the progeny.
-----------------------------------	---

Mandibles smooth distally on the inner side. Margins usually strongly dentate.	Mandibles distally on the inner side usually with numerous small teeth. Margins with or without very small teeth.
--	---

Salivary duct distally paired (except Ampulicinae and Sphecinae).	Salivary ducts fused distally.
---	--------------------------------

Maxillae with galea and palpus.	Maxillae without galea.
---------------------------------	-------------------------

### Immature stages

Ontogenesis in the Sphecidae does not differ from the general pattern in Hymenoptera Aculeata.

The egg is of the "hymenopteriform" type (Clausen, 1940), i.e. elongate, sausage-shaped, slightly curved. The larvae are of the "grub-like" type, i.e. practically unpigmented, blind and without limbs. They are adapted to a very protected life, usually in total darkness in cells. The period of larval development is short, lasting at most three weeks. Normally, the adult larva spins a complete cocoon, into whose surface material from the surroundings (food remains, sand grains, saw-dust and the like) is often incorporated. Especially within the Pemphredoninae the cocoon is very reduced, often to a thin wall just behind the partition between it and the next cell in front. At this stage probably all North European species hibernate. The prepupa (the pharate pupa) is "intermediate" between larva and pupa in many characters. Thus the developing rudiments of antennae, wings and legs are seen rather distinctly through the cuticula of the larva. After a moult the pupa appears: it is of the exarate type (free pupa). In many species within the Crabronini and Trypoxylon (Larrinae) the pupa, laterally on the abdomen, is provided with stout spine- or tooth-like processes (Fig. 19). In Pemphredon and closely related genera a curved, spine-like process is found above the lateral ocelli. The pupal stage normally lasts about 14 days, whereupon the imago emerges.

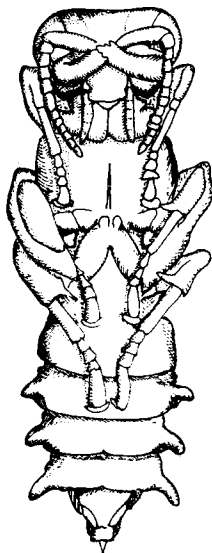

Fig. 19. Pupa of *Ectemnius cavifrons* (Thomson), ♂, in ventral view.

The study of the morphology and taxonomy of Sphecid-larvae is not at all an easy task, and only relatively few scientists have succeeded in developing and mastering an adequate technique. In this connection primarily Grandi (1961) and Evans, (1956-64) should be mentioned. I believe the most intricate work of describing sphecid larvae in detail at specific level is far beyond the scope of the present publication, and I have therefore chosen to present only an introductory description followed by a key to subfamilies and genera. Where descriptions of species exist, references are given throughout the text.

#### THE MATURE LARVA.

The head capsule is strongly sclerotized, but only slightly pigmented. In front view the head is usually almost circular (Fig. 20). Many species have a pair of obliquely running bands (parietal bands) anteriorly on the head. These are usually more strongly pigmented. The antennae are very short, one-segmented with three small sensillae distally, or the antennal papilla may be absent so that the three sensillae arise directly from the antennal orbits. The epistomal suture between the lower part of frons and clypeus may be absent. The labrum is very well developed, very mobile in relation to the clypeus, often slightly bi-lobed, and may be provided with a weak longitudinal furrow (Fig. 21). The labrum is richly provided with setae and sensillae, which often are of great systematic value. The ventral part of the labrum (epipharynx) is usually spinulose, and along the anterior border normally provided with a row of sensillae. The mandibles

are very strongly sclerotized and usually strongly pigmented. They are pronounced biting tools and have teeth on the inner side. The morphology of the mandibles shows good systematic characters. The maxillae are large and muscular, slightly sclerotized with two papillae distally. The lateral papilla (maxillary palp) is normally the largest, distally carrying 3-4 sensillae (Fig. 21). The median papilla (galea) is distally provided with 2 sensillae (Fig. 22). The main part of the maxillae is composed of the stipes, which is without pronounced morphological characters. The medial part, "lacinial area" (Fig. 22), is strongly differentiated morphologically by the rough, often strongly spinulose surface. The labium consists of the very large postmentum and the smaller prementum. The latter carries the one-segmented labial palps, whose morphology is very similar to that of the maxillary palps. They often bear three sensillae distally (Fig. 22). Medially openings (the spinneret) for the silk-producing salivary glands are found. These terminate either in an unpaired, narrow "slit" or paired on more or less prolonged tubes (Figs. 20, 22).

The body shape is more or less cylindrical, usually slightly C-shaped curved, or more or less depressed, with convex sides. The thorax is without limbs. The abdomen consists of ten segments, of which the last may be slightly modified into a sub- and supra-anal lobe (Philanthinae). Laterally a row of well developed pleural lobes are found. The tracheal system is holopneustic with two pairs of

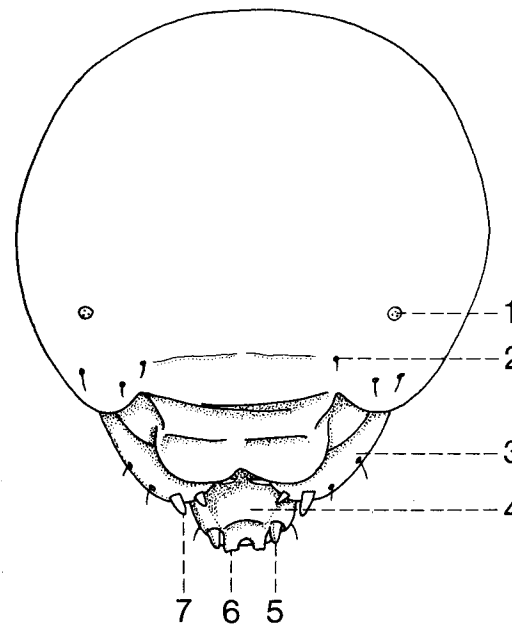

Fig. 20. Head of larva of *Passaloeus eremita* Kohl in frontal view. - 1: antenna; 2: anterior tentorial pit; 3: maxilla; 4: labium; 5: labial palpus; 6: spinneret; 7: maxillary palpus. Drawn after scanning electron micrograph.



thoracic and eight pairs of abdominal spiracles. The spiracle-bearing sclerite, peritremen, is more strongly sclerotized and more strongly pigmented than the remaining integument. The distal part of the tracheae is enlarged to two chambers, first a subatrium, and distally a jar-shaped atrium, whose walls are thick and strongly sclerotized. On the transition between these a ring of stout spines (collar spines) is usually found. The structure of the wall of the atrium provides good characters, of use in taxonomy.

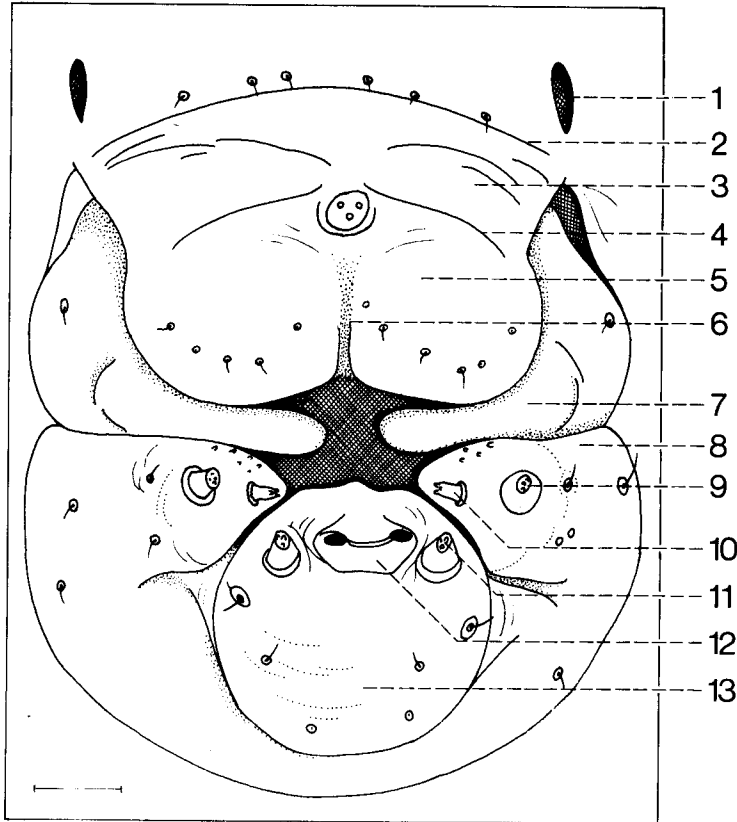

Fig. 21. Mouthparts of larva of *Passaloecus eremita* Kohl. - 1: anterior tentorial pit; 2: epistomal suture; 3: clypeus; 4: clypeo-labral suture; 5: labrum; 6: median labral line; 7: mandible; 8: maxilla; 9: maxillary palpus; 10: galea; 11: labial palpus; 12: spinneret; 13: labium. Drawn after scanning electron micrograph. Scale: 0.1 mm.

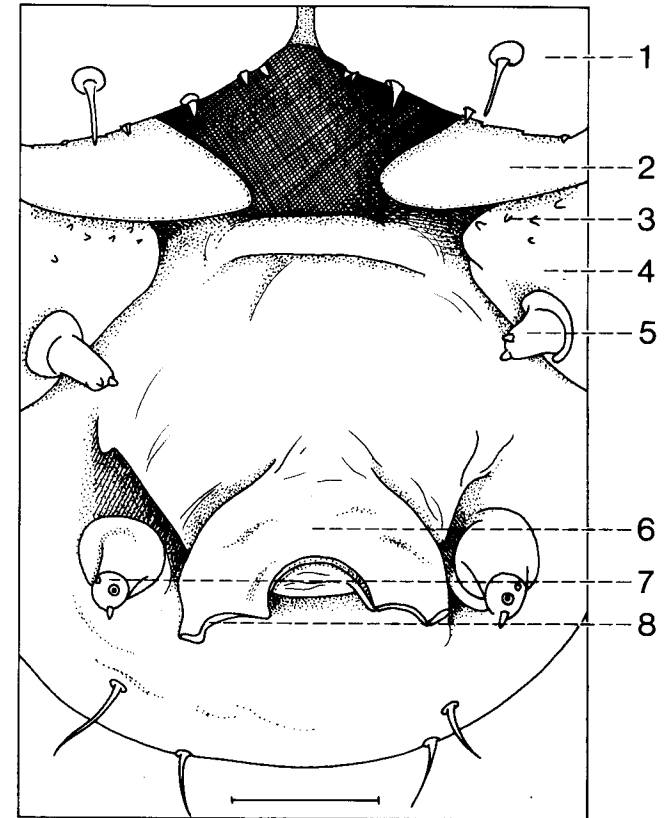

Fig. 22. Mouthparts of larva of *Passaloecus eremita* Kohl, enlarged. - 1: labrum; 2: mandible; 3: lacinial area (spinulose); 4: maxilla; 5: galea; 6: spinneret; 7: three sensillae of labial palpus; 8: salivary opening. Drawn after scanning electron micrograph. Scale: 0.1 mm.

### Key to genera of Sphecidae, larvae

(The larvae of *Dinetus*, *Didineis*, *Argogorytes*, *Dienoplus*, and *Lestica* are unknown).

- 1    Apex of labium very broad, the spinneret a long, transverse slit (Fig. 23), with prominent raised lips .....

- Apex of labium more narrow, the spinneret paired, each opening at the end of a process of varying length (Fig. 24). Galea usually much shorter than maxillary palpi (absent in Spilomena) ..... 5
- 2(1) Lips of the spinneret much more prominent laterally than medially. Labial palpus very short. Antennae with five sensillae ..... Dolichurus Latreille
- Lips of spinneret not more prominent laterally than medially. Labial palpus about as long as the maxillary palpus. Antennae with three sensillae ..... 3
- 3(2) Mandibles stout and heavy, less than twice as long as their maximal width, without spinules on their upper surfaces ..... Sphex Linné
- Mandibles slender, more than twice as long as their maximal width, bearing minute spinules on their upper surfaces ..... 4
- 4(3) Basal tooth of mandibles represented by a row of about seven minute denticles. (This character was used by Evans (1959) to separate the two following genera. However, small denticles are not present in P. affinis, Fig. 25) ..... Podalonia Spinola

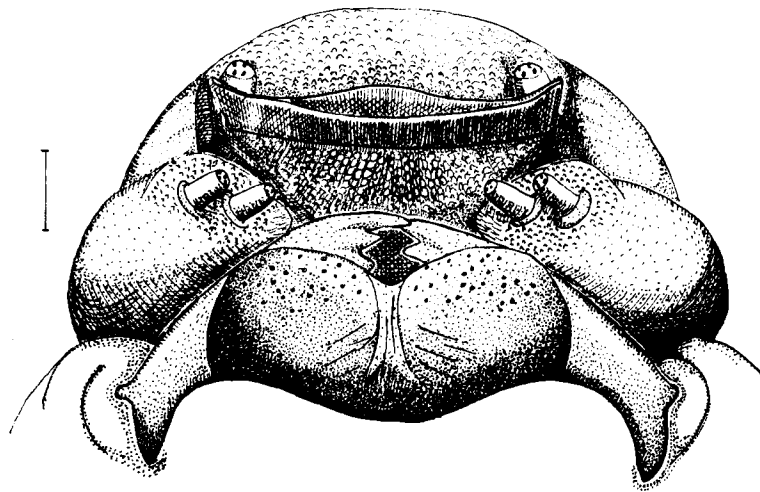

Fig. 23. Spinneret and other mouthparts of larva of Podalonia affinis (Kirby). Drawn after scanning electron micrograph. Scale: 0.1 mm.

- Basal tooth of mandibles simple or subdivided, but always protuding as a distinct tooth (Fig. 26) .... Ammophila Kirby
- 5(1) Anus directed caudally and situated at the apex of the abdomen or very nearly so (slightly preapical in Psenini, Pemphredoninae). Antennal papillae present (Fig. 27) (absent in most Pemphredonini) ..... 6
- Anus directed ventrally and situated well before the apex of the abdomen, the anal segment forming a rounded or conical lobe beyond the anus. Antennal papillae absent, the sensillae arising directly from the membrane of the orbits (Fig. 28) ..... 22
- 6(5) Maxillae with the apex directed somewhat mesally and closely associated with the labium and hypopharynx (Fig. 29). Epipharynx often spinulose laterally, but the spinules not or rarely reaching the midline ..... 7
- Maxillae projecting apically as lobes which are free from the labium and hypopharynx (Fig. 30). Epipharynx spinulose (rarely papillose) over much of its

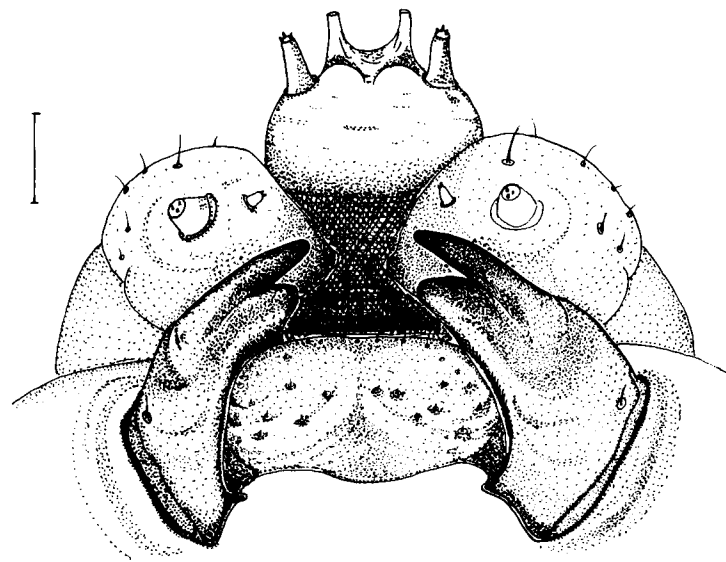
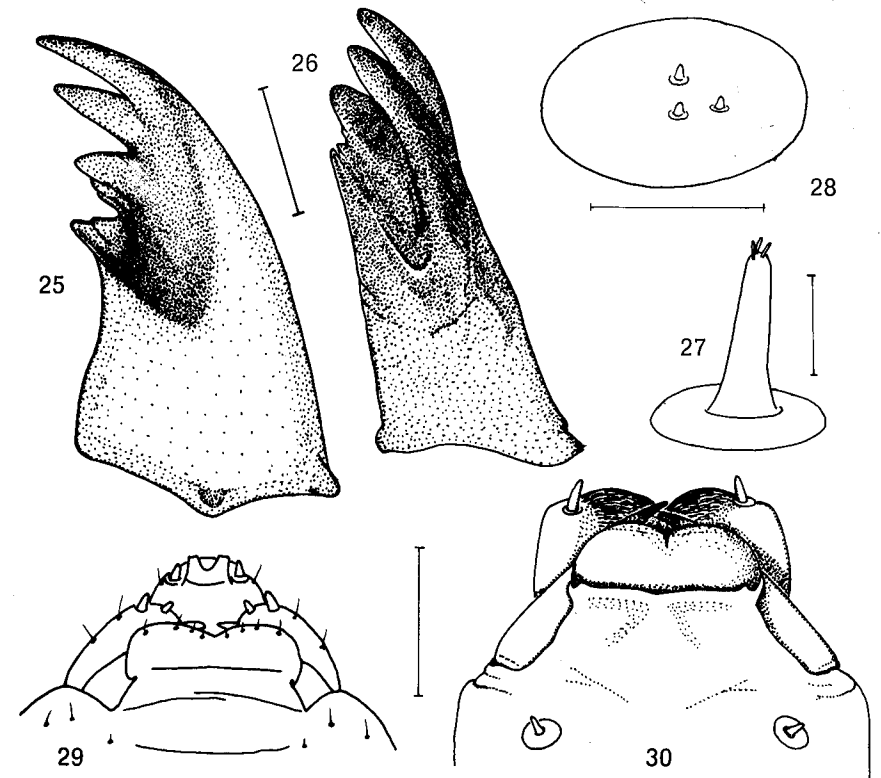

Fig. 24. Spinneret and other mouthparts of larva of Psenulus concolor (Dahlbom). Drawn after scanning electron micrograph. Scale: 0.1 mm.

- surface. Antennal papillae always present. Soil-nesting. Cocoon present ..... 17
- 7(6) Mandibles with a weakly pigmented area laterally near the base, this area bearing a considerable number of setae. Fourth abdominal segment humped dorsally. Parietal bands strong. Epipharynx strongly spinulose laterally. Soil-nesting. Cocoon present. (Astatinae) ..... Astata Latreille
- Mandibles with a single seta laterally near the base. Fourth abdominal segment not more humped than any other. Parietal bands absent or very weak. Epipharynx rather weakly spinulose antero-laterally (Pempredoninae) ..... 8
- 8(7) Antennal papillae absent, the sensory cones arising directly from the membrane of the orbit (Fig. 28) .. 9
- Antennal papillae present, usually long and stout, bearing the sensory cones distally (Fig. 27) ..... 13
- 9(8) Integument spinulose at least antero-dorsally. Apical margin of labrum usually with a pigmented band. Wood-nesting ..... 10
- Integument entirely naked. Apical margin of labrum usually not pigmented ..... 12
- 10(9) Integument rather evenly spinulose anteriorly, including the thoracic dorsum. Cocoon absent. Cell-partitions entirely or partly made of resin .... Passaloeus Shuckard
- Integument spinulose only on parts of the sides and venter. Cell-partitions made of wood-dust .... 11
- 11(10) Mandibles short and stout, only slightly longer than maximal width basally, six-dentate, broadly convex internally, the apical tooth very large, projecting far beyond the marginal teeth. Cocoon present. .... Ceratophorus Shuckard
- Mandibles less heavily built, much longer than wide, never with more than five teeth. Cocoon absent in Nordic Species ..... Pempredon Latreille
- 12(9) Body somewhat fusiform. Maxillae slightly roughened by small papillae or spinules. Soil-nesting. Cocoon present ..... Diodontus Curtis

- Body more cylindrical. Maxillae smooth. Wood-nesting. Cocoon absent ..... Stigmus Panzer
- 13(8) Head broader than high. Mandibles broad and short, terminating in four teeth which surround a strong concavity (Fig. 31). Spinnerets truncate apically (Fig. 32). Integument with sparse spinules. Wood-nesting. Cocoon absent ..... Psenulus Kohl
- Head as high as or higher than broad. Mandibles slender, the three or four apical teeth all in about the same plane. Spinnerets acute apically. Cocoon present ..... 14



Figs. 25-26. Larval mandibles of 25: Podalonia affinis (Kirby); 26: Ammophila pubescens Curtis. Scale: 0.1 mm.  
 Figs. 27-28. Larval antennae of 27: Psenulus concolor (Dahlbom); 28: Passaloeus eremita Kohl. Scale: 0.04 mm.  
 Figs. 29-30. Maxillae and other mouthparts of larva of 29: Passaloeus eremita Kohl; 30: Cerceris rybyensis (L.). Scale: 0.4 mm.

- 14(13) Very small species, maximal length about 3 mm. Head entirely naked. Only distal tip of mandibles pigmented. Galea absent (Fig. 33). Wood-nesting. Cocoon present ..... Spilomena Shuckard
- Species of normal size. Head with a few rather large setae. Larger part of the mandibles pigmented. Galea present as distinct papillae ..... 15
- 15(14) Apical margin of labrum with a series of convexities, each bearing a small sensillum. Spinnerets long and spinelike. Soil-nesting ..... Psen Latreille
- Apical margin of labrum with a row of very small nipple-like sensillae. Spinnerets shorter, slightly more exceeding than palpi ..... 16
- 16(15) The penultimate tooth of the mandibles is replaced by a concavity. Soil-nesting ..... Mimesa Shuckard
- Mandibles with two weak teeth on the inner margin. Wood-nesting ..... Mimumesa Malloch
- 17(6) Integument smooth or very inconspicuously spinulose. Opening between the atria and subatria of spiracles armed with a circlet of spines (except in Alysson) (Fig. 34). Last abdominal segment simple. Galea fairly strong, at least half as long as the palpi. (Nyssoninae) ..... 18
- Integument clothed nearly allover with densely set, small spinules. Opening between atria and subatria simple, unarmed. Posterior end of body modified for locomotion, either the supra-anal or sub-anal lobe protuberant, or the two lobes together forming a tubular process (Fig. 35). Galea much smaller than the maxillary palpi and may be hardly visible in certain species. (Philanthinae) ..... 21
- 18(17) Frons with from one to six dark-tipped, nipple-like processes. Labrum with only minute setae, if any ..... 19
- Frons without dark-tipped, nipple-like processes. Labrum with strong setae ..... 20
- 19(18) Frons with six nipple-like processes. Antennal papillae unusually long ..... Alysson melleus Say  
(No European species described. A. melleus is

a North American species, keyed by Evans & Cheng Shan Lin, 1956).

- Frons with one or three nipple-like processes. Antennal papillae short ..... Nysson Latreille
- 20(18) Sides of apical margin of labrum with at most a few weak, barely protruding spines. Lacinal area papillose ..... Gorytes Latreille
- Sides of the apical margin of labrum and the lacinal area roughly spinose (Fig. 36) ..... Bembix Fabricius

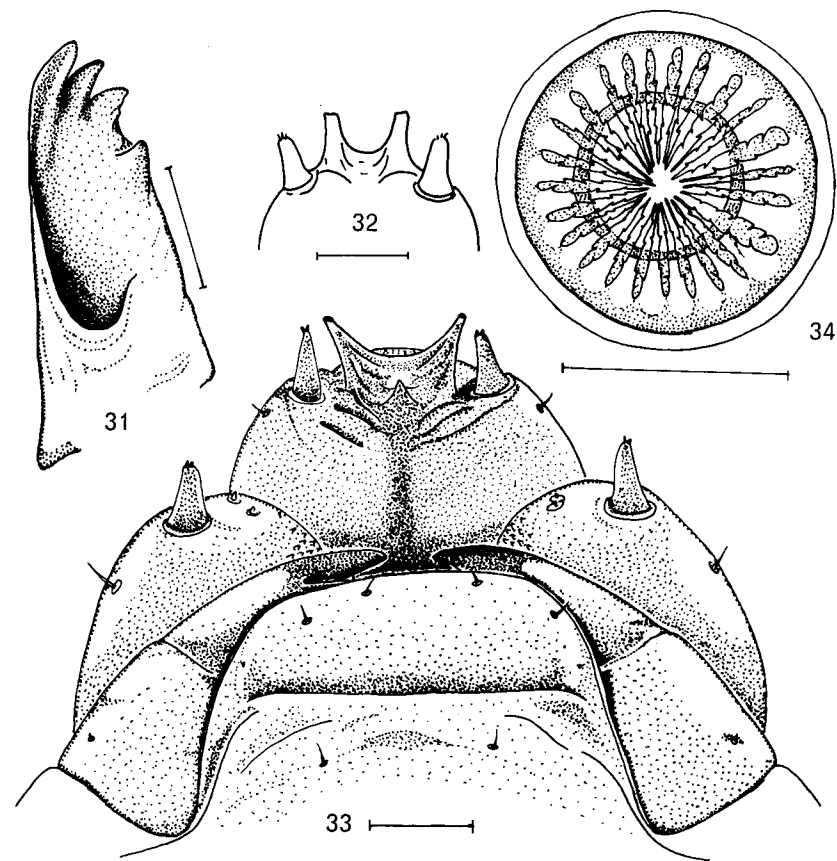

Fig. 31. Larval mandible of Psenulus concolor (Dahlbom). Scale: 0.1 mm.  
 Fig. 32. Spinneret of larva of Psenulus concolor (Dahlbom). Scale: 0.1 mm.  
 Fig. 33. Larval mouthparts of Spilomena enslini Blüthgen. Scale: 0.04 mm.  
 Fig. 34. Larval spiracle of Bembix littoralis Handlirsch. Scale: 0.1 mm.

- 21(17) Mandibles tridentate. Epipharynx with spinules over most of its surface ..... Philanthus Fabricius
- Mandibles bidentate. Epipharynx with a considerable area medio-basally which is devoid of spinules or papillae..... Cerceris Latreille
- 22(5) Body with pleural lobes and a series of dorso-lateral prominences conically produced, dark-tipped, and armed with numerous short, stout spinules (Fig. 37, 38). Mandibles without setae, on the inner margin with a strong concavity beyond which there are teeth connected by a blade-like portion. Oral surface of labium not spinulose. Soil-nesting. Cocoon present. (Mellinae) .... Mellinus Fabricius
- Body without pleural lobes or dark-tipped, armed prominences. Mandibles with one (rarely two) setae laterally near the base, and otherwise not as above. Oral surface of prementum of labium at least partly spinulose. Cocoon present. (Larrinae) ..... 23
- 23(22) Inner margin of maxilla with a large angular lobe arising from near the base (Fig. 39). Labrum with the inner margin mostly bristly, but with several strong setae set in the margin near the midline. Mandibles stout, terminating in four or five teeth which surround a strong concavity. Wood-nesting. .... Trypoxylon Latreille
- Inner margin of maxillae without angular lobe basally. Margin of labrum slightly to strongly bristly ..... 24
- 24(23) Inner margin of maxilla with a weak to fairly strong apical or subapical prominence which is clothed with spinules or papillae. Pleural lobes of thorax often conically protuberant. Opening between atria and sub-atria of spiracles sometimes armed with a circlet of spines (Fig. 34) ..... 25
- Inner margin of maxilla simple, smoothly rounded, spinulose. Pleural lobes of thorax rounded (in diapausing larvae all the pleural lobes may be somewhat conical). Opening between atria and sub-atria always simple ..... 27

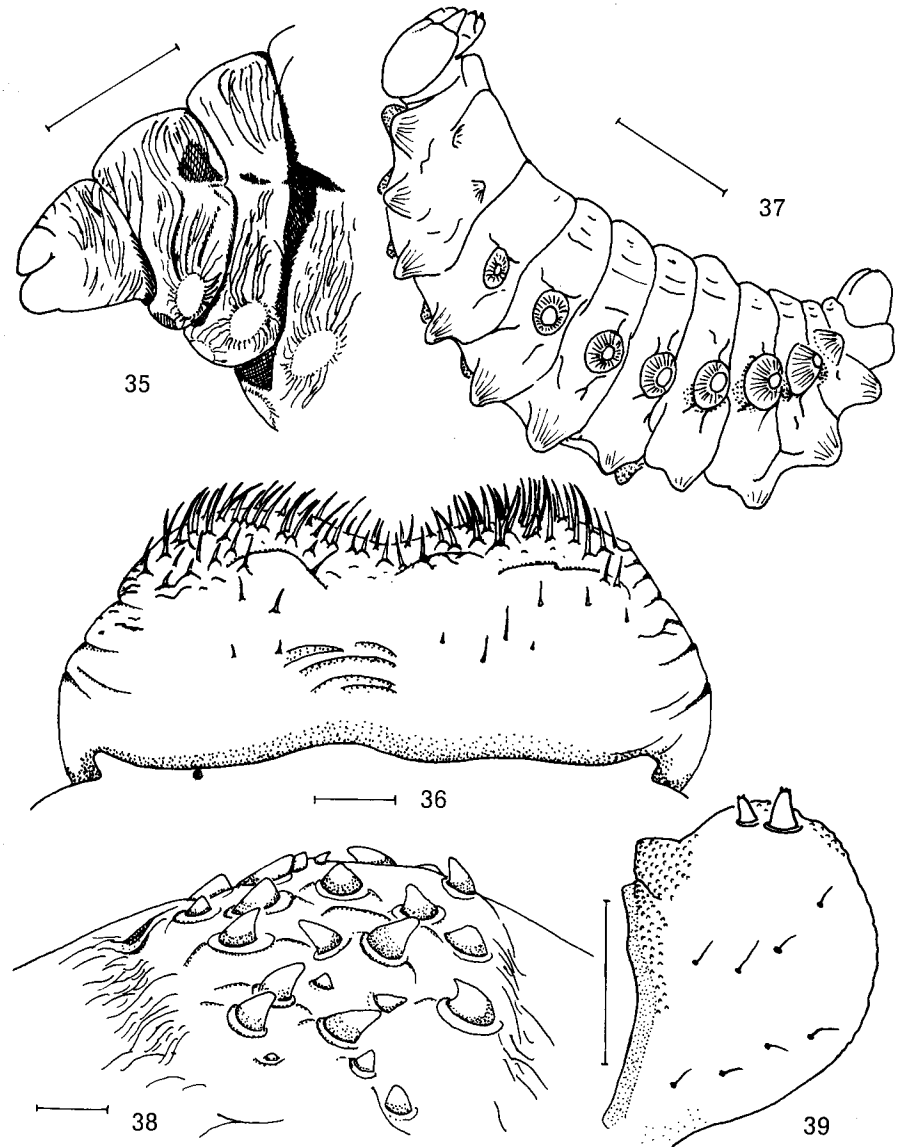
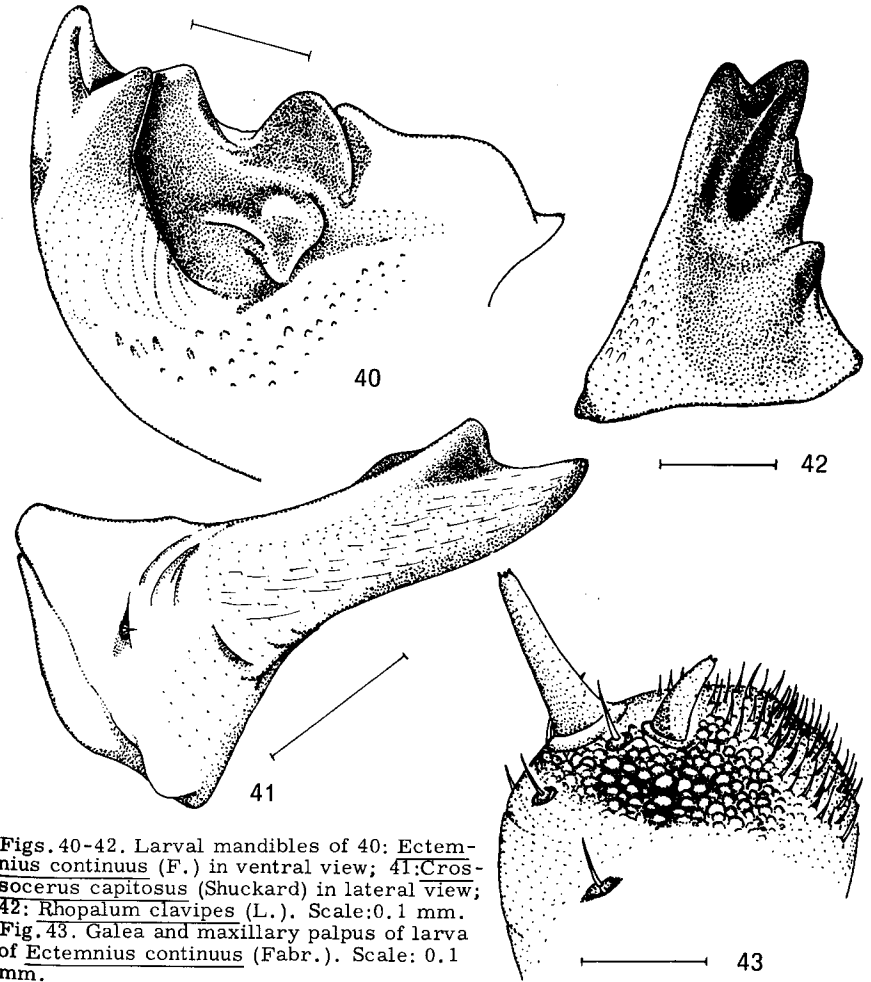

Fig. 35. Posterior part of abdomen of larva of Cerceris rybyensis (L.) in lateral view. Scale: 1 mm.  
 Fig. 36. Larval labrum of Bembix littoralis Handlirsch. Scale: 0.1 mm.  
 Fig. 37. Larva of Mellinus arvensis (L.) in lateral view. Scale: 1 mm.  
 Fig. 38. Spinules of thoracic prominences of larva of Mellinus arvensis (L.). Scale: 0.02 mm.  
 Fig. 39. Larval maxilla of Trypoxylon figulus (L.). Scale: 0.02 mm.

- 25(24) Inner margin of maxilla prolonged into a sharp point.  
Soil-nesting ..... Miscophus Jurine 26  
- Inner margin of maxilla not prolonged as above .... 26
- 26(25) The salivary openings at the end of very short processes. Antenna without sensory cones. Inner margin of maxilla with at most some elongate papillae. Wood-nesting ..... Nitela Latreille  
- Each salivary opening at the end of a long process. Antenna with three sensory cones distally. Inner margin of maxilla densely spinulose. Soil-nesting .... Tachysphex Kohl
- 27(24) Mandibles slender, with three or four teeth in about the same plane, or the apical two one above the other, never with a distinct ventral, apical concavity ..... 28  
- Mandible stouter, usually with five, sometimes with only four teeth and a distinct ventral, apical excavation (Fig. 40) ..... 31
- 28(27) Galea very short, not more than one third the length of the maxillary palpus. Soil-nesting Lindenius Lepeletier & Brullé  
- Galea at least nearly half as long as the maxillary palpus ..... 29
- 29(28) Oral surface of prementum of labium with a very dense covering of very short spinules. Soil-nesting, Entomognathus Dahlbom  
- Oral surface of prementum with fewer and longer spinules ..... 30
- 30(29) Apical two teeth of mandibles juxtaposed in such a way that the mandibles are strongly bifid in lateral view (Fig. 41). Soil-nesting species in the subgenera Hoplocrabro, Crossocerus, and Acanthocrabro ..... Crossocerus Lepeletier & Brullé  
- Mandibles not bifid, all teeth almost in the same plane (Fig. 42). Wood-nesting ..... Rhopalum Stephens
- 31(27) Epipharynx with a large area medio-apically which is devoid of spinules, either bare or papillose. Soil-nesting ..... Oxybelus Latreille  
- Epipharynx spinulose medio-apically ..... 32
- 32(31) Mandibular teeth strong; the ventral excavation also strong (Fig. 40). Galea about two-thirds as long

as the maxillary palpus (Fig. 43). Wood-nesting, Ectemnius Dahlbom  
Mandibular teeth slightly less prominent, the fifth (ventral, basal) tooth especially weak; the ventral excavation somewhat weaker than above. Galea slightly more than half as long as the maxillary palpus. Soil-nesting ..... Crabro Fabricius



Figs. 40-42. Larval mandibles of 40: Ectemnius continuus (F.) in ventral view; 41: Crossocerus capitosus (Shuckard) in lateral view; 42: Rhopalum clavipes (L.). Scale: 0.1 mm. Fig. 43. Galea and maxillary palpus of larva of Ectemnius continuus (Fabr.). Scale: 0.1 mm.

## Key to genera of Sphecidae, adults

- |       |   |  |
|-------|---|--|
| 1     | Forewings with one cubital cell (Figs. 55, 56) .....  | 2  |
| -     | Forewings with 2 - 3 cubital cells .....  | 15   |
| 2(1)  | Inner orbits with a deep U-shaped emargination (Fig. 59) .....  | <u>Trypoxylon</u> Latreille (p.263)          |
| -     | Inner orbits without emargination .....   | 3  |
| 3(2)  | Cubital and discoidal cells fused (Fig. 55). Metanotum with two posteriorly directed projections (Fig. 60) .....  | 4  |
| -     | Cubital and discoidal cells not fused. Metanotum without projections .....  | 5  |
| 4(3)  | Propodeum with a strong median thorn-like prolongation (Fig. 60) .....  | <u>Oxybelus</u> Latreille (p.270)            |
| -     | Propodeum at most with a tiny spine ....  | <u>Belomicrus</u> Costa (p.268)              |
| 5(3)  | Inner orbits diverging ventrally. Ommatidia of equal size .....   | <u>Nitela</u> Latreille (p.259)              |
| -     | Inner orbits converging ventrally. Ommatidia of very varying size .....   | 6  |
| 6(5)  | Abdomen with a long petiolus, segment 1 about twice as long as wide, apically distinctly expanded (Fig. 61) ..... | <u>Rhopalum</u> Stephens (p.351)             |
| -     | Abdomen without a distinct petiolus .....   | 7  |
| 7(6)  | Ocelli placed in an obtuse-angled triangle .....  | 8  |
| -     | Ocelli placed in a right-angled or equilateral triangle .....   | 12   |
| 8(7)  | Mandibles single-toothed apically (Fig. 62). Both sexes have a pygidial area .....                                | 9  |
| -     | Mandibles apically with 2 - 3 teeth (Fig. 63). Only females have a pygidial area .....                            | 10   |
| 9(8)  | Eyes strongly pubescent. Mandibles proximally with a deep ventral emargination (Fig. 62) .....                    | <u>Entomognathus</u> Dahlbom (p.344)         |
| -     | Eyes naked. Mandibles without ventral emargination .....  | <u>Lindenius</u> Lepeletier & Brullé (p.346) |
| 10(8) | Mesopleuron without precoxal carina in front of coxa 2. Males with 13 antennal segments. Tibia 1                  |  |

usually with large shield-like dilations. Pygidial area in females flat ..... Crabro Fabricius (p.286)

- Mesopleuron with a short and sharp angular or arcuate precoxal carina (Fig. 64). Males with 12 antennal segments ..... 11

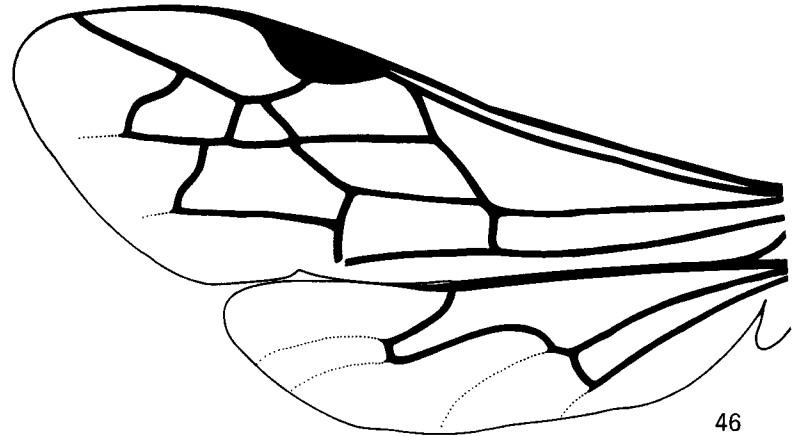
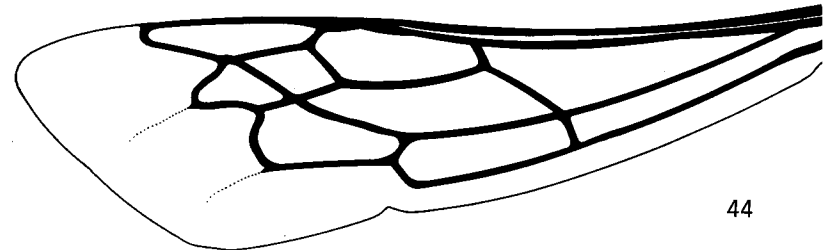

Figs. 44-45. Forewings of 44: Sphecx rufocinctus Brullé; 45: Ammophila sabulosa (L.).  
Fig.46. Wings of Mimumesa sp.

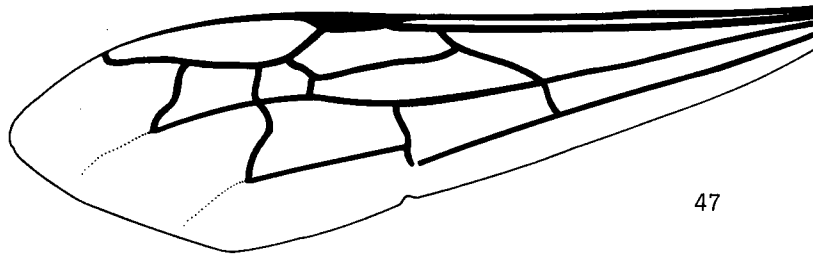

47

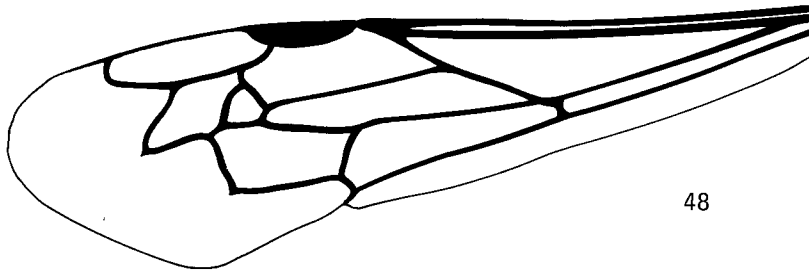

48

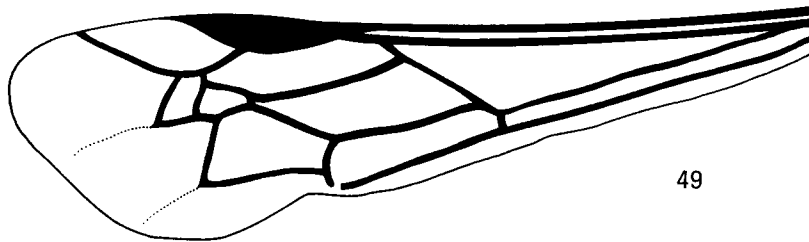

49

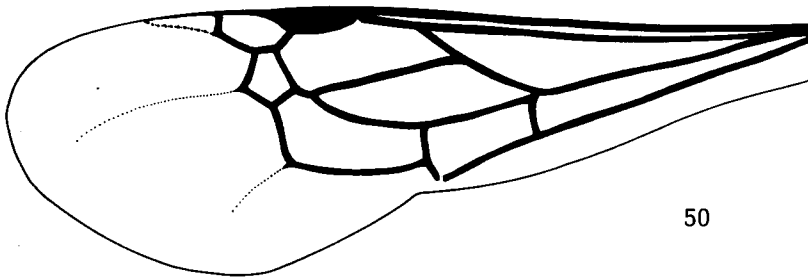

50

Figs. 47-50. Forewings of 47: Mimesa sp.; 48: Cerceris sp.; 49: Alysson sp.; 50: Dinetus pictus (Fabr.).

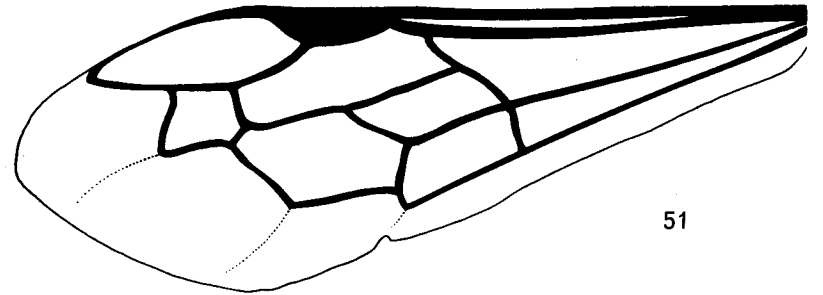

51

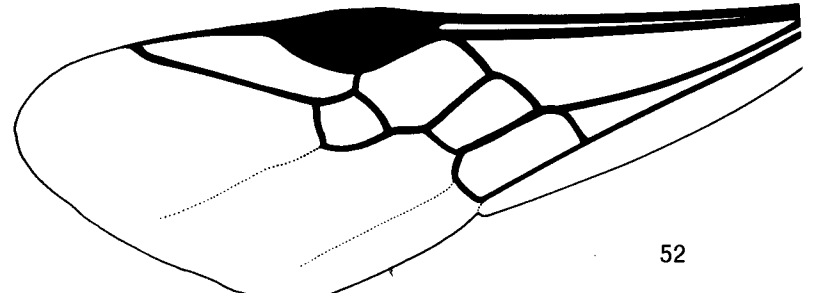

52

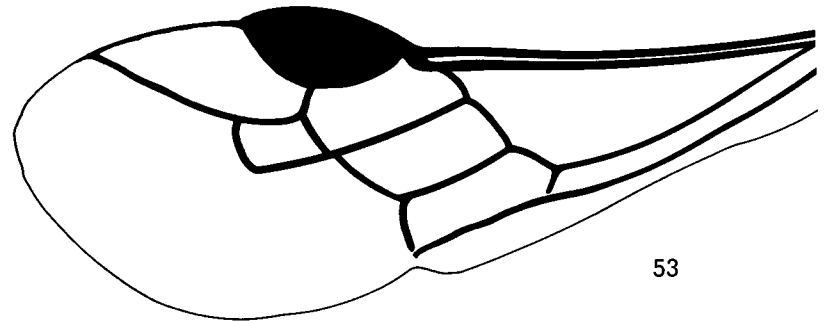

53

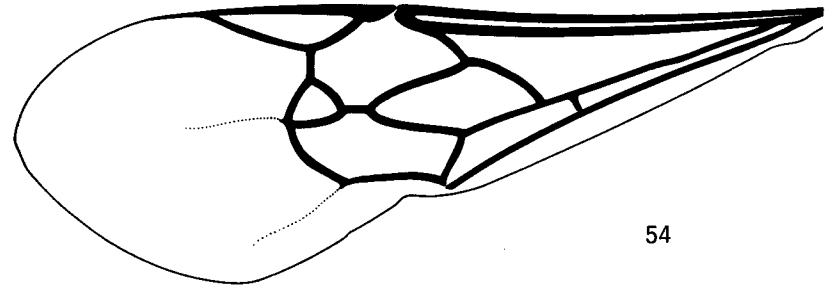

54

Figs. 51-54. Forewings of 51: Pemphredon lugubris (Fabr.); 52: Stigmus sp.; 53: Spilomena sp.; 54: Miscophus sp.



- 11(10) Terga very coarsely and deeply punctate. Facial fovea distinct. Pygidial area in females flat. Lestica Billberg (p.335)
- Terga with sculpture very fine or almost absent. Facial fovea indistinct or missing. Pygidial area in females excavated in a groove apically, and surrounded by strong, golden bristles (Fig. 65) ..... Ectemnius Dahlbom (p.298)
- 12(7) Abdomen without yellow markings ..... Crossocerus Lepeletier & Brullé (p.358)
- Abdomen with yellow markings ..... 13
- 13(12) Mesopleuron smooth, without carina, even, or with a small tooth anterior to coxa 2. Propodeum usually with a distinctly delimited area cordiformis which is smooth shining, and impunctate (Fig. 66). Males with 13 antennal segments . Crossocerus Lepeletier & Brullé (p.358)
- Mesopleuron with a short and sharp angular or arcuate precoxal carina (Fig. 64). Propodeum without a delimited area cordiformis, the sculpture striate or rugose. Males with 12 antennal segments ..... 14
- 14(13) Terga very coarsely and deeply punctate. Facial fovea distinct (cf. Fig. 377). Pygidial area in females flat ..... Lestica Billberg (p.335)
- Terga with very fine or almost absent sculpture. Facial fovea indistinct or absent. Pygidial area excavated in a groove apically, and surrounded by strong, golden bristles (Fig. 65) ..... Ectemnius Dahlbom (p.298)
- 15(1) Forewings with two cubital cells (Fig. 51) ..... 16
- Forewings with three cubital cells (Fig. 45) ..... 23
- 16(15) Second cubital cell petiolate (Fig. 54) ..... Miscophus Jurine (p.252)
- Second cubital cell not petiolate ..... 17
- 17(16) Petiolus much longer than wide ..... 18
- Petiolus not longer than wide ..... 20
- 18(17) Forewings with one discoidal cell (Fig. 52) .. Stigmus Panzer (p.128)
- Forewings with two discoidal cells (Fig. 51) ..... 19
- 19(18) Frons between antennal sockets with a strong, obtuse horn ..... Ceratophorus Shuckard (p. 102)

- Frons between antennal sockets with at most a small spine ..... Pemphredon Latreille (p. 81)
- 20(17) Forewings with only one discoidal cell (Fig. 53). Very small species ..... Spilomena Shuckard (p.132)
- Forewings with two discoidal cells ..... 21
- 21(20) Inner orbits strongly diverging ventrally. Mandibles proximally with a ventrally directed rounded tooth

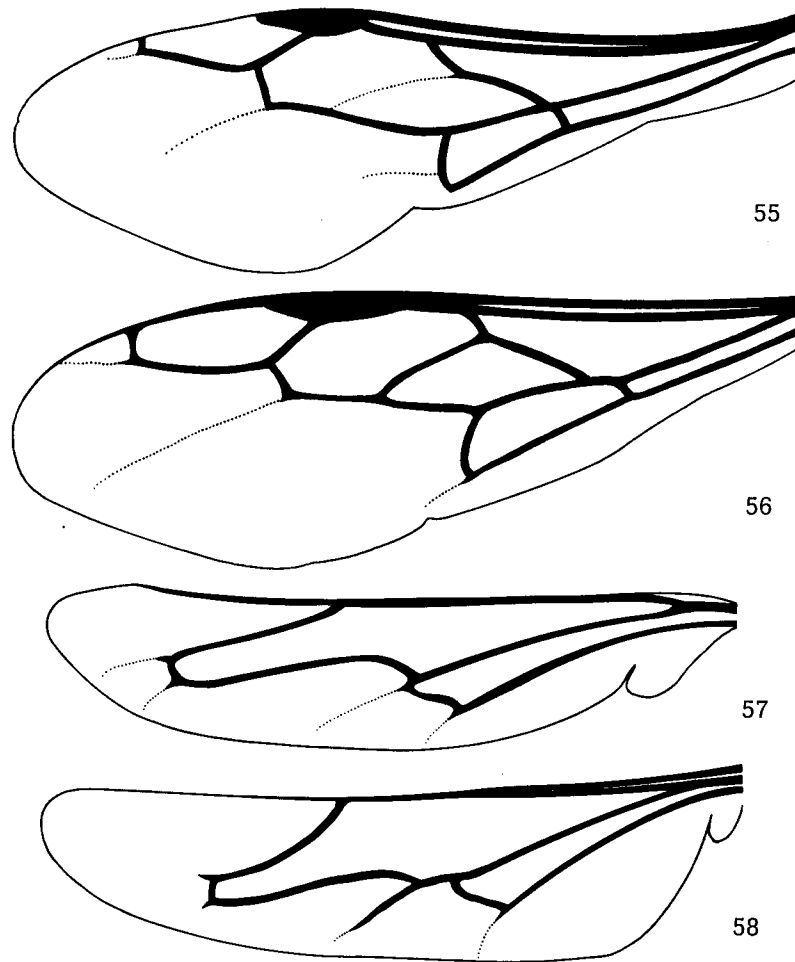

Figs.55-56. Forewings of 55: Oxybelus sp.; 56: Rhopalum sp.  
Figs. 57-58. Hindwings of 57: Gorytes sp.; 58: Dienoplus sp.

	(Fig. 67). Radial cell short, with an accessory cell (Fig. 50). Body with extensive yellow markings .....	<u>Dinetus</u> Panzer (p.238)
-	Inner orbits parallel or converging ventrally. Mandibles without ventral tooth. Radial cell long, gradually tapering towards apex (Fig. 52). Body black ..	22
22(21)	Mesopleuron generally smooth, finely punctate, with one (sometimes double) vertical and one or two horizontal, coarsely pitted furrows (Fig. 68). Tibia 3 without spines. Females without pygidial area .....	<u>Passaloecus</u> Shuckard (p.113)
-	Mesopleuron with rugose sculpture, without distinct furrows. Tibia 3 with small spines. Females with pygidial area .....	<u>Diodontus</u> Curtis (p.105)
23(15)	Abdomen petiolate .....	24
-	Abdomen sessile .....	31
24(23)	Tergum 1 covering the whole dorsal face of the petiolus, posteriorly swollen (Fig. 69). Abdomen with yellow or yellowish-white markings .....	<u>Mellinus</u> Fabricius (p.223)
-	Tergum 1 not covering the petiolus which is formed by the first sternum alone. Abdomen without yellow markings .....	25
25(24)	Petiolus sharply edged (Fig. 70). Antennae gradually thickened distally, last segment rounded apically. Females with very weak tarsal pecten .....	26
-	Petiolus rounded in section. Antennae evenly filiform. Females with a very strong tarsal pecten (Fig. 71)	29
26(25)	Media of hindwing leaves Media + Cubitus distally to anal cell (Fig. 46) .....	<u>Psenulus</u> Kohl (p.161)
-	Media of hindwing leaves Media + Cubitus proximally to apex of anal cell (Fig. 57) .....	27
27(26)	The first discoidal transverse vein joins the second cubital cell, and the second joins the third (Fig. 46). Frons with a small spine between antennal sockets. Antennal segments in male strongly excavate ventrally (Fig. 72). Petiolus very long, weakly marginated .....	<u>Psen</u> Latreille (p.150)

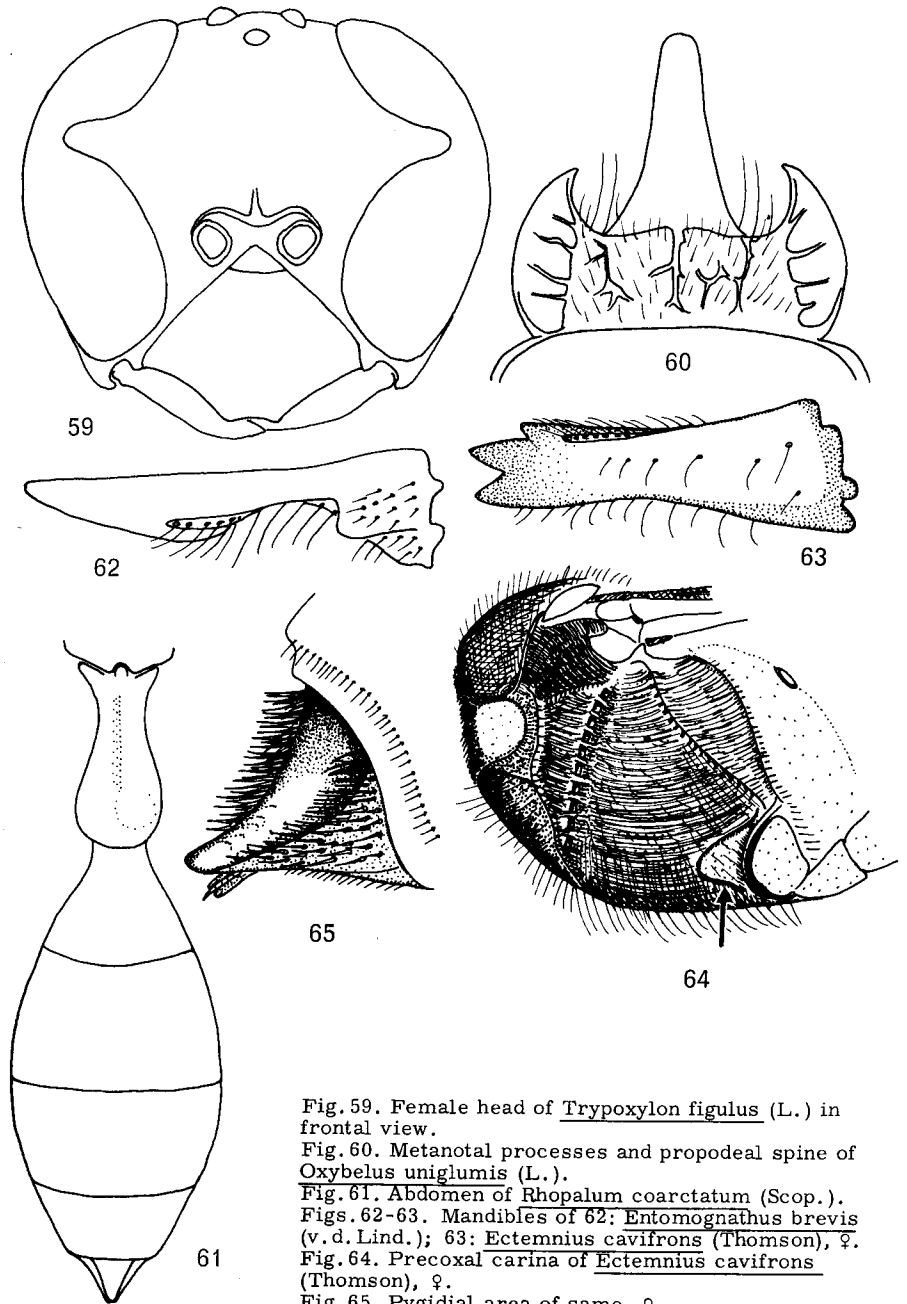

Fig. 59. Female head of Trypoxylon figulus (L.) in frontal view.  
 Fig. 60. Metanotal processes and propodeal spine of Oxybelus uniglumis (L.).  
 Fig. 61. Abdomen of Rhopalum coarctatum (Scop.).  
 Figs. 62-63. Mandibles of 62: Entomognathus brevis (v. d. Lind.); 63: Ectemnius cavifrons (Thomson), ♀.  
 Fig. 64. Precoxal carina of Ectemnius cavifrons (Thomson), ♀.  
 Fig. 65. Pygidial area of same, ♀.

- Both discoidal transverse veins join the second cubital cell (Fig. 47). Frons without spine, at most tuberculate between antennal sockets. Antennal segments in males not excavate, although occasionally with tyloidea. Petiolus strongly margined (Fig. 73) ..... 28
- 28(27) Abdomen black. From the anterior ocellus a longitudinal carina goes forward. This joins a doubly arcuate transverse carina below the antennal sockets (Fig. 74). Clypeus without a transverse pad. Mesopleuron smooth. The ventral part of the epicnemial carina continues as the acetabular suture (Fig. 75) ..... *Mimumesa* Malloch (p.152)
- Abdomen proximally red. The longitudinal and transverse carinae on frons very weak or absent. Clypeus in females usually with a transverse pad. Mesopleuron dull, microsculptured, distinctly punctate. The acetabular suture absent ..... *Mimesa* Shuckard (p.143)
- 29(25) Petiolus in lateral view as in Fig. 76, composed of both tergum 1 and sternum 1 ..... *Ammophila* Kirby (p.75)
- Petiolus only composed of sternum 1, in lateral view as in Fig. 77 ..... 30
- 30(29) First discoidal transverse vein joins the second the cubital cell, the second joins the third. Second cubital cell rhomboid (Fig. 44) ..... *Sphex* Linné (p.67)
- Both discoidal transverse veins join the second cubital cell, which is trapezoid (Fig. 45) .. *Podalonia* Fernald (p.70)
- 31(23) Labrum triangular, very strongly prolonged (Fig. 78) ..... *Bembix* Fabricius (p.202)
- Labrum not prolonged ..... 32
- 32(31) Second cubital cell petiolate (Fig. 48) ..... 33
- Second cubital cell not petiolate ..... 36
- 33(32) Abdominal segments constricted (Fig. 235). Apex of radial cell truncate or rounded (Fig. 48) *Cerceris* Latreille (p.170)
- Abdominal segments not constricted. Apex of radial cell acute ..... 34
- 34(33) Stigma very small. Propodeum short, with strong lateral teeth (Fig. 79). Inner orbits strongly converging ventrally. Head and thorax very coarsely

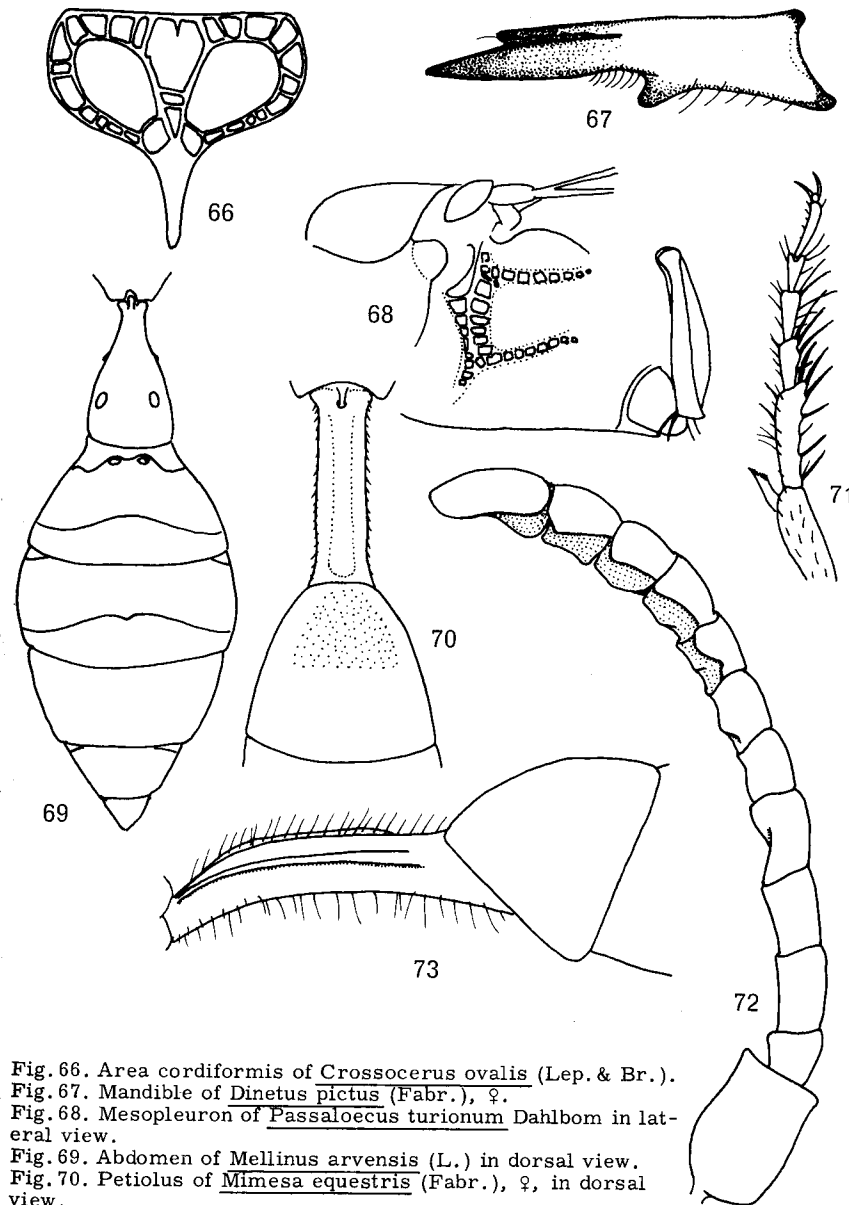
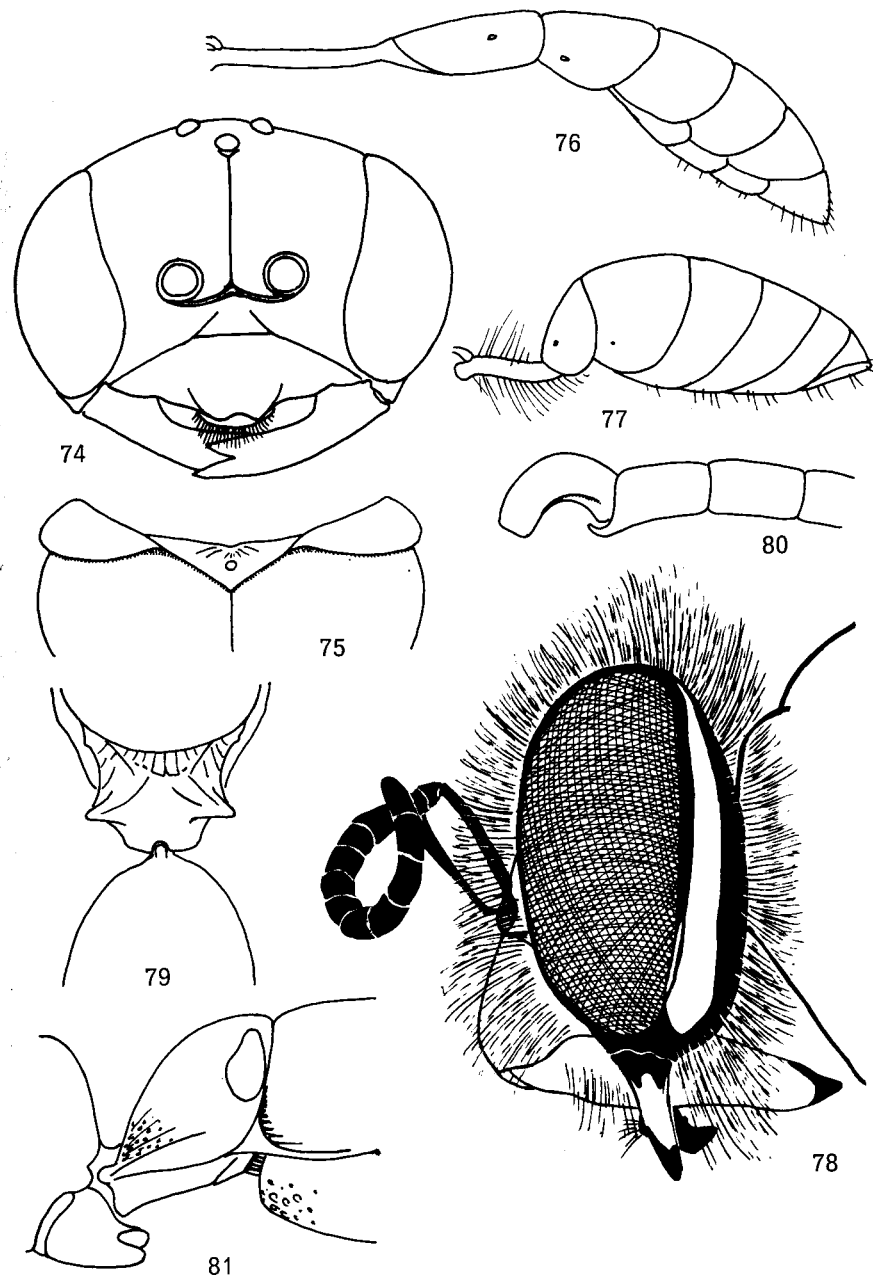

Fig. 66. Area cordiformis of *Crossocerus ovalis* (Lep. & Br.).  
 Fig. 67. Mandible of *Dinetus pictus* (Fabr.), ♀.  
 Fig. 68. Mesopleuron of *Passaloecus turionum* Dahlbom in lateral view.  
 Fig. 69. Abdomen of *Mellinus arvensis* (L.) in dorsal view.  
 Fig. 70. Petiolus of *Mimesa equestris* (Fabr.), ♀, in dorsal view.  
 Fig. 71. Tarsus 1 of *Podalonia hirsuta* (Scopoli).  
 Fig. 72. Antenna of *Psen ater* (Fabr.), ♂.  
 Fig. 73. Petiolus of *Mimumesa atratinus* (F. Morawitz) in lateral view.

- sculptured ..... Nysson Latreille (p.204)
- Stigma of normal size. Propodeum long, with or without very small lateral teeth. Inner orbits not or very slightly converging ventrally. Head and thorax superficially sculptured ..... 35
- 35(34) First and second discoidal transverse veins join the second cubital cell (Fig. 49). Nervulus antefurcal. Abdomen with yellow spots. Last antennal segment in males normal ..... Alysson Panzer (p.218)
- First discoidal transverse vein joins the first cubital cell, the second joins the second. Nervulus postfurcal. Abdomen without yellow spots. Last antennal segment in male C-shaped, antennal segment 12 distally with a small spine (Fig. 80), Didineis Wesmael (p.216)
- 36(32) Both discoidal transverse veins join the second cubital cell ..... 37
- First discoidal transverse vein joins the second cubital cell, the second the third ..... 41
- 37(36) Inner orbits almost parallel or converging ventrally ..... 38
- Inner orbits strongly diverging ventrally ..... 40
- 38(37) Abdomen with a strongly depressed furrow between the sterna 1 and 2, the latter strongly dilated, in lateral view as Fig. 81 ..... Argogorytes Ashmead (p.187)
- Abdomen without a furrow between sterna 1 and 2, the latter not dilated ..... 39
- 39(38) Media of hindwing leaves Media + Cubitus proximally to apex of anal cell (Fig. 57). Larger species with three or more yellow transverse bands on abdomen ..... Gorytes Latreille (p.191)
- Media of hindwing leaves Media + Cubitus distal to anal cell (Fig. 58). Smaller species with whitish markings on abdomen ..... Dienoplus Fox (p.199)

Fig. 74. Head of Mimumesa dahlbomi (Wesmael), ♀, in frontal view.  
 Fig. 75. Mesopleuron of Mimumesa dahlbomi (Wesmael) in ventral view.  
 Fig. 76. Abdomen of Ammophila sabulosa (L.), ♀, in lateral view.  
 Fig. 77. Abdomen of Podalonia hirsuta (Scop.), ♀, in lateral view.  
 Fig. 78. Head of Bembix rostrata (L.), ♀, in lateral view.  
 Fig. 79. Propodeum of Nysson spinosus (Forster) in dorsal view.  
 Fig. 80. Apex of antenna of Didineis lunicornis (Fabr.), ♂, in lateral view.  
 Fig. 81. Anterior part of abdomen of Argogorytes mystaceus (L.) in lateral view.



- 40(37) Tibia 2 with a single apical spur. The lateral ocelli elongate and very flattened ..... Tachysphex Kohl (p. 242)
- Tibia 2 with two apical spurs. The lateral ocelli normal, circular and convex ..... Astata Latreille (p. 229)
- 41(36) Pronotum very long. Claws with a proximal tooth. Body almost entirely black ..... Dolichurus Latreille (p. 64)
- Pronotum short. Claws without teeth. Body with yellow markings ..... Philanthus Fabricius (p. 182)

## SUBFAMILY AMPULICINAE

The species of the subfamily Ampulicinae vary in size from 4.5 - 25 mm. Eyes elongate, situated laterally on the head, the inner orbits parallel or slightly diverging ventrally. Antennae filiform, 12-segmented in females, 13-segmented in males, inserted below a raised plate. Maxillary palpus 6-segmented, labial palpus with four segments. Prothorax elongate, the humeral tubercle extending posteriorly to the tegulae. Scutum usually with strong longitudinal furrows throughout its length. Propodeum large, strongly carinate dorsally, often with lateral prominences. Mesopleuron without epicnemium. Abdomen more or less petiolate (except in Dolichurus). Females without pygidial area. Forewings primarily with three cubital cells and two discoidal cells. Tibia 2 with two spurs. Claws dentate.

The larvae resemble those of Sphecinae, suggesting a close relationship (Evans, 1959b), but deviate in the following characters: the integument is devoid of spinules; the parietal bands are weak; the epipharynx is spinulose only laterally, and then very weakly; the mandibles lack the basal pores; the inner margins of the maxillae bear only short spinules; and the lips of the spinneret generally project farther laterally than medially.

The subfamily is mainly confined to the tropical regions, comprising six genera of which Ampulex is the largest. Only three species in western and northern Europe. The species nest in cavities both in the soil and in decayed wood near the ground. The prey consists of cockroaches.

### Genus Dolichurus Latreille

Dolichurus Latreille, 1809: 387.

Type-species: Pompilus corniculatus Spinola, 1808.

Genus easily recognizable by the long pronotum, and the very characteristic sculpture on scutum and propodeum (Fig. 82). Antennae long and slender. Coxa 3 very large. Femur 3 rather strongly dilated proximally. Claws with basal tooth. Abdomen has six visible segments in females; in the males the last three segments are telescoped and partly concealed within tergum 3. Females without pygidial area and without tarsal pecten on tarsus 1. Forewings with three cubital cells. First and second mcu join second and third cubital cells respectively.

The Ampulicinae are mainly distributed in the tropics, where the genus Ampulex is rather common. Dolichurus comprises about twenty species, of which two are found in Europe.

The nest is of simple construction, consisting of a single larval chamber, which often is only a pre-existing cavity in the ground. Larval provision consists of cockroaches (Blattodea), e.g. Ectobius.

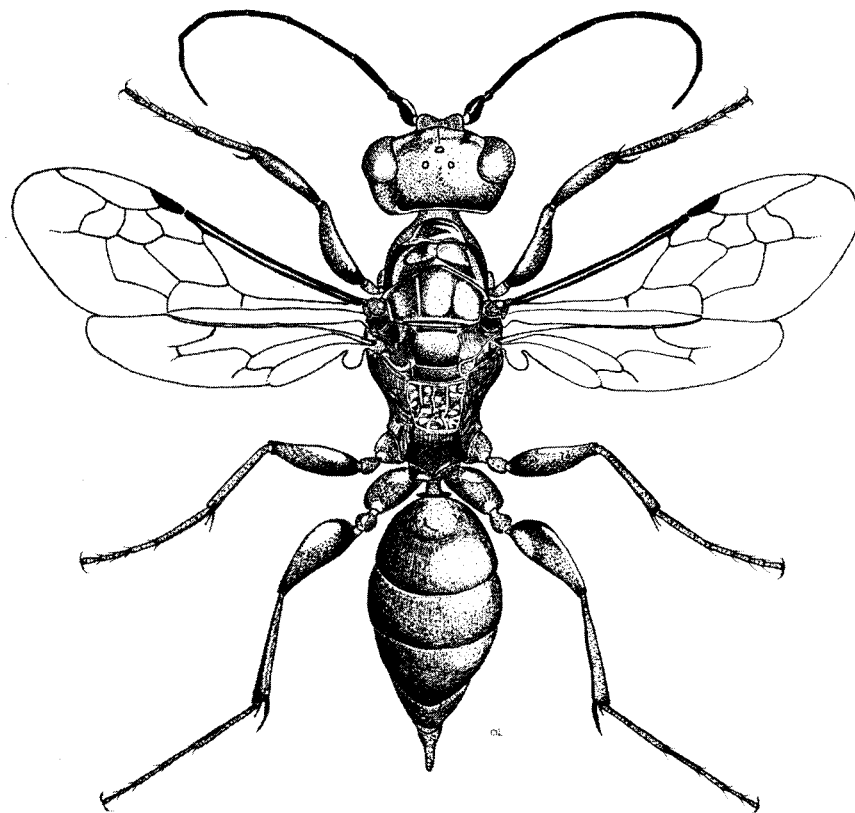

Fig. 82. Female of Dolichurus corniculatus (Spin.). Length: 8-9 mm.

## 1. DOLICHURUS CORNICULUS (Spinola, 1808)

Fig. 82.

Pompilus corniculus Spinola, 1808: 52.

Female: 8-9 mm. Shining black. Head in front view almost circular. Clypeus strongly convex in the middle, with a faint longitudinal keel and 4-6 strong forward directed black bristles. Antennae long and slender, frontal face of scapus with an oblique longitudinal keel. Frons with irregular rugae. Scutum almost impunctate, with very well developed parapsidal furrows. Thorax dorsally with scattered, strong black bristles. Mesopleuron with coarse rugoso-punctation. Propodeum dorsally with four strong longitudinal carinae connected with each other by numerous transverse rugae. Posterior side of propodeum laterally with a backward directed spine. Abdomen smooth and shining with very fine and scattered punctation. Legs black, tarsi brownish. Tibia 2 with a distinct longitudinal furrow along anterior border.

Male: 7-8 mm. Clypeus with a whitish yellow spot on each side of the very strong longitudinal keel. Pubescence white, sparse. Sculpture of head coarse, consisting of shallow pits. Pubescence long and erect. Whole thorax rather densely punctate, with whitish pubescence. Punctation of mesopleuron rather strong. Propodeum as in female. Abdomen distinctly punctate, hairy with weak constrictions between the three first segments. Sterna strongly and densely punctate. Legs black, long and slender. Tibia 2 without longitudinal furrow.

Widely distributed and rather common throughout Denmark and Fennoscandia. - Sweden: northern distribution limit in Vrm. and Gstr. - Norway: a single specimen from AK, Bygdeø. - Finland: northern limit in Ok and ObS. In Soviet Karelia known from Ib. - Widely distributed in Europe, southwards to northern Africa.

The species prefers sandy areas: paths, fire breaks in coniferous forests, or areas along watercourses. The species does not dig a nesting-burrow, but uses pre-existing cavities in the soil. The food, which consists of the cockroaches Ec-tobius lapponicus L. and Phyllodromica megerli Fieber (= Aphlebia punctata Charp.), is treated in a very characteristic way, since the prey is only slightly paralyzed. Before it is carried to the nest, the wasp bites off two-thirds of each antenna of the prey. The very elongate egg is placed between coxae 2 of the prey and hatches in three to four days. The larva takes about ten days to develop. Larva described by Maneval, 1939.

## SUBFAMILY SPHECINAE

A well-defined, probably monophyletic unity, including the largest sphecid species known (52 mm). Head large, inner orbits parallel or converging ventrally, diverging only in rare cases. Antennae long, filiform, 12-segmented in females, 13-segmented in males, inserted relatively high up on frons. Maxillary palpus 6-segmented, labial palpus 4-segmented. Clypeus large. Mandibles very powerful, with strong teeth. Pronotum usually elongate, the humeral tubercles do not reach the tegulae. Thorax moderately sculptured. Mesopleuron with an epicnemial carina or furrow, epicnemium absent. Propodeum much elongated. Abdomen petiolate, the petiolus composed of either sternum 1 alone or in addition of tergum 1 and sternum 2 (postpetiolus). Pygidial area absent. Legs long and powerful. Tibia 2 with two apical spurs. Tarsus 1 of females with a strong tarsal pecten. Forewings with three cubital and two discoidal cells.

Larvae characterized as follow: integument spinulose or granulose; setae of head short or absent; parietal bands well developed; antennal papillae absent; labrum biconvex; mandibles stout, terminating in four teeth, galea as long as or longer than maxillary palpus; spinneret consisting of a transverse slit with prominent raised lips (Evans & Lin, 1956). The transverse spinneret is unique to the Ampulicinae and the Sphecinae among the Sphecidae.

The subfamily is mainly tropical and subtropical, comprising 19 genera of which only four occur in Europe. The Nordic species are all soil-nesters, whereas several exotic species either display arboreal nesting habits or construct their nests with mud (mud daubers). A few act as inquilines. The nests are provisioned with Orthoptera, Aranea, lepidopterous or (rarely) hymenopterous larvae.

## Genus Sphex Linné

Sphex Linné, 1758: 569.

Type-species: Sphex flavipennis Fabricius, 1793.

Robust, medium to very large species (Fig. 83), very similar to the species of Podalonia, but the petiolus is much shorter (in the Scandinavian species), and also the thorax and legs are more powerful. Forewings with 3 cubital cells, of which the second and third receive the first and second recurrent veins respectively. The second cubital cell forms an equilateral rhomboid. Eyes large, strong-

ly convex, inner orbits parallel, slightly converging in males. The median ocellus is considerably larger than the lateral ones. Mandibles rather short, strongly curved and very powerful. Clypeus large, antennae inserted high up on frons. Tibiae very spiny, especially in females. Claws with two strong, rounded, basal teeth (*Sphex* s. str.). Females with highly developed tarsal pecten.

The genus is cosmopolitan and represented by a very large number of species, most of which occur in tropical and subtropical regions. To this genus belong some of the largest Hymenoptera.

## 2. *SPHEX RUFOCINCTUS* Brullé, 1832

Fig. 83.

*Sphex rufocincta* Brullé, 1832: 367.

*Sphex maxillosa* auctt., nec Fabricius.

Female: 16-23 mm. Head in frontal view slightly broader than high. The whole lower part of the face covered by a double pilosity consisting partly of dense, adpressed silvery hairs, partly of long and pale, very thick, erect bristles. Head also ventrally with long, pale hairs. Clypeus very large, strongly convex; the anterior border strongly depressed. Mandibles red-yellow or red-brown with black apex. The whole thorax very shallowly and sparsely punctate and mat due to the interstitial microsculpture. Propodeum dorsally with very fine and dense, sometimes indistinct transverse striae, with long and rather sparse, pale pubescence. Petiolus seen from above about twice as long as broad, black. Anterior half of abdomen red-brown coloured. First tergum with a black spot of variable size. Second tergum without black markings. Third tergum more or less extensively black coloured. Tibia 1 and tibia 2 and tarsus 1 and tarsus 2 with extensive rust-red or red-brown pattern. Foretarsi with numerous, very strong, compressed tarsal spines. Wings distinctly darkened. Third cubital cell triangular, since second and third cubital transverse veins join at the radial vein.

Male: 15-20 mm. Antennae long and slender, segments ventrally with two pairs of longitudinal carinae, between the medial ones is found an elongate excavation which is dull and flattened at the bottom. Inner orbits distinctly converging ventrally. Clypeus and lower part of face with dense silvery pubescence. Anterior border of clypeus without depression, or slightly depressed. Sculpture and pubescence of thorax as in female. Propodeum dull, dorsally with fine granulate sculpture, occasionally with distinct transverse striation. Legs entirely black. Tarsus with quite short pecten. Black spot on first tergum usually larger than in female, and often an extensive black pattern on third tergum.

The species seems to maintain an isolated population on Gfl. (Ljungan, Irevik, and on Fårön) and might be considered a postglacial warm relict. The records from Vg. have not been verified. - The distribution area primarily covers the Mediterranean, Asia Minor and South-Siberian steppes.

At the end of a tunnel, about 15 cm long, a horizontal larval cell is constructed in the same way as in *Ammophila* and *Podalonia*, but there are reliable observations (Olberg, 1966), showing that several larval chambers were connected with the same entrance. While hunting takes place, the entrance to the nest is left open. The paralyzed nymphs of grasshoppers or crickets are carried or dragged to the nest. Each cell is provisioned with 3-5 specimens. The egg hatches after 3-4 days, and the larva is fully grown already after about 18 days. Recorded cleptoparasites are *Metopia campestris* Fallén and *M. argyrocephala* Meig. (Dipt., Miltogrammatidae).

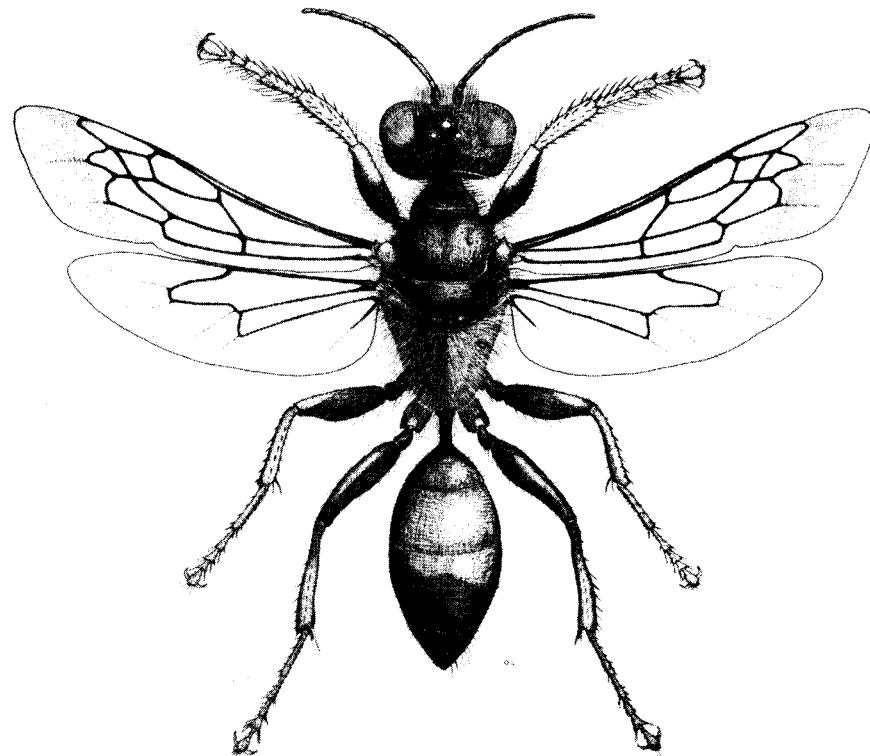

Fig. 83. Female of *Sphex rufocinctus* Brullé. Length: 16-23 mm.

## Genus *Podalonia* Fernald

*Podalonia* Fernald, 1927: 1.

Type-species: *Ammophila violaceipennis* Lepeletier, 1845.

Large, robust, red-and-black wasps (Fig. 84). The genus is characterized by the rather short petiolus and by the first tergum seen in profile being fairly high and short (Fig. 86). There is no distinct constriction between this and the second tergum. The head in front view is short and broad, with dense, strong sculpture. The mandibles of the female are very long and powerful, with three teeth on the inner side. Those of the male are shorter and strongly curved, with only a single tooth on the inner side. The labio-maxillary complex is elongate in both sexes. Scutum with strong sculpture. Tarsus 1 of the female is strongly asymmetrically dilated, with very strong pecten. The pilosity of the head and dorsal thorax is long, strong and dense, especially in males. The males are otherwise considerably more slender than the females, with dense, bright silvery pubescence on the lower part of the face. Forewings with three cubital cells, of which the second is joined by both recurrent veins. Tibia 2 with two spurs.

The genus, which is represented by three species in Fennoscandia and Denmark, is distributed over large areas of the world. All species are associated with sandy biotopes, fully exposed to the sun. The nests are constructed in the ground, consisting only of a single larval chamber. The prey consists of soil-living larvae, e.g. of Noctuidae (Lepidoptera).

### Key to species of *Podalonia*

- 1 Inner side of claws near base with a small sharp tooth. Propodeum dorsally with distinct diagonally striate sculpture ..... 4. *affinis* (Kirby)
- Claws unarmed. Propodeum dorsally never distinctly diagonally striate, but with irregular wrinkled or pitted rugosity ..... 2
- 2 (1) Female: Tarsus 1 strongly asymmetrically dilated, tarsal pecten very strong, the spines slightly dilated apically (Fig. 88). Metatarsus ventrally with or without a few very weak spines. Male: Mandibles with at least centre reddish-brown. Hairs on scutum silvery, sometimes with black base. Clypeus comparatively short and broad (Fig. 85)..... 5. *luffii* Saunders

Female: Tarsus 1 except the metatarsus very slightly asymmetrically dilated. Tarsal spines tapering (Fig. 87). Metatarsus near ventral midline with a row of 3-4 strong spines. Male: Mandibles mainly black. Pubescence of scutum greyish-white. Clypeus comparatively narrow, its anterior border distinctly emarginate ..... 3. *hirsuta* (Scopoli)

### 3. *PODALONIA HIRSUTA* (Scopoli, 1763)

Figs. 84, 86, 87.

*Sphex hirsuta* Scopoli, 1763: 292.

*Podalonia viatica* auctt.

Female: 16-23 mm. Head and thorax with dense, very strong punctation and usual-

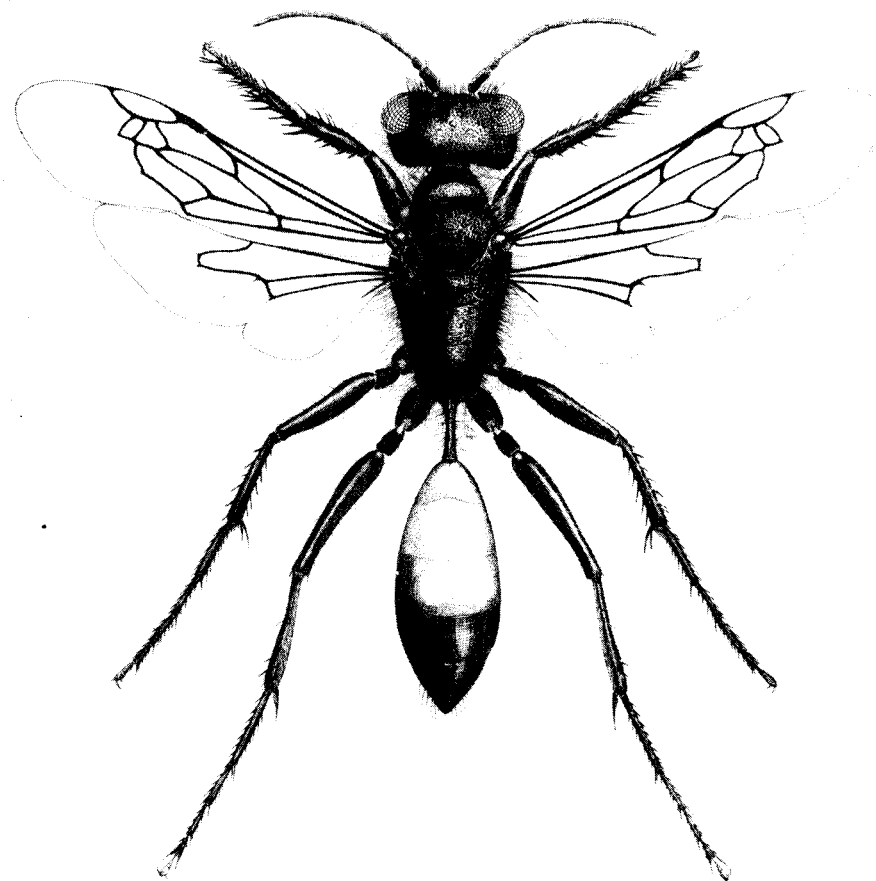

Fig. 84. Female of *Podalonia hirsuta* (Scop.). Length: 16-23 mm.



ly very long, strong pilosity, but this may be much reduced, especially in specimens from mountainous regions, both in Fennoscandia and Central Europe. Anterior border of clypeus with a slight central projection which often has almost right-angled corners. Propodeum dorsally with irregular, superficial pits or rugose, not distinctly different from the sculpture on the lateral parts. First and second tergum as well as basal part of third red or brownish-red. Tarsal segments of forelegs comparatively weakly dilated (Fig. 87). Pretarsus with a very small pulvillus. Claws without basal tooth.

Male: 14-20 mm. Head in front view distinctly narrowing ventrally, clypeus relatively long and narrow, almost plane. The long erect pubescence on head entirely black, on scutum consisting of a mixture of black and more or less greyish hairs. Sculpture of thorax and propodeum as in female. First, second and much of third tergum red. First tergum with at most a quite small, black, basal spot. Pulvilli of pretarsi large.

This is the most frequent *Podalonia*-species in northern Europe. - Denmark: common on dry, sunny soils throughout the country. - Sweden: northwards to Dlr. and Gstr. - Norway: only a few records, but probably common in the lowland areas in the south. - Finland: a south-eastern distribution, northwards to Kb. - Soviet Karelia: Ib and Kr. - Distributed through much of the Palaearctic region, eastwards to Inner Mongolia.

The nests are found in sandy areas: fire breaks and open areas near the coast, but may also be constructed in sandy slopes or gravel pits. The entrance-burrow is 6-7 cm long and runs obliquely down, where it is finally expanded to form a larval chamber. The sequence of the excavation and provisioning of the nest etc. is as follows: 1) Hunting and paralyzing of prey; 2) Excavation of nest; 3) Transportation of prey and egg-laying; 4) Closing and camouflaging of nest. It is noteworthy that the entrance is not temporarily closed as in *Ammophila*. The prey consists of naked larvae of soil-living Noctuidae, e.g. *Agrotis*, of which only a single individual represents the provision. It is stated (Adlerz, 1903) that while excavating the larva, the female "may be mistaken", instead digging out a larva buried and paralyzed by another individual. The larva is paralyzed by a number of stings, mainly in the thoracic locomotory ganglia, and carried to the future nesting place, where it is deposited temporarily in a tuft of grass or the like. Excavation takes place by means of the forelegs, the mandibles being used when pebbles and small twigs are being removed. The excavated material is scattered round the entrance. When construction of the nest is finished, the wasp retrieves the paralyzed larva dragging it into the nest. The egg is laid ventrally in the thoracic region. The entrance is closed with sand, which is stamped together, during which the wasp makes short buzzing sounds while its wings are folded. The vibrat-

ions probably help to pack the sand grains more tightly together. The egg hatches after 4-5 days. About ten days later the wasp-larva is fully grown and spins a pale brownish, rather solid three-layered cocoon. The imago usually emerges at the end of May, when also the hibernated females can be observed. Both males and females spend the night in cavities in the soil, often in slopes among roots of e.g. *Ammophila arenaria* (Marram Grass). Both males and females may be found sucking nectar from flowers of e.g. *Jasione montana* and *Succisa pratensis*. As parasite on imagines is recorded *Paraxenos sphecedarum* (Duf.) (Strepsiptera).

#### 4. *PODALONIA AFFINIS* (Kirby, 1798)

*Ammophila affinis* Kirby, 1798: 205.

Female: 16-20 mm. Head and thorax dorsally with very sparse, often almost absent black hairs. Punctuation on scutum weak and rather sparse, interspaces shining, with microsculpture. Anterior border of clypeus without projecting median lobe. Propodeum dorsally finely diagonally striate, dull with interstitial granulat-

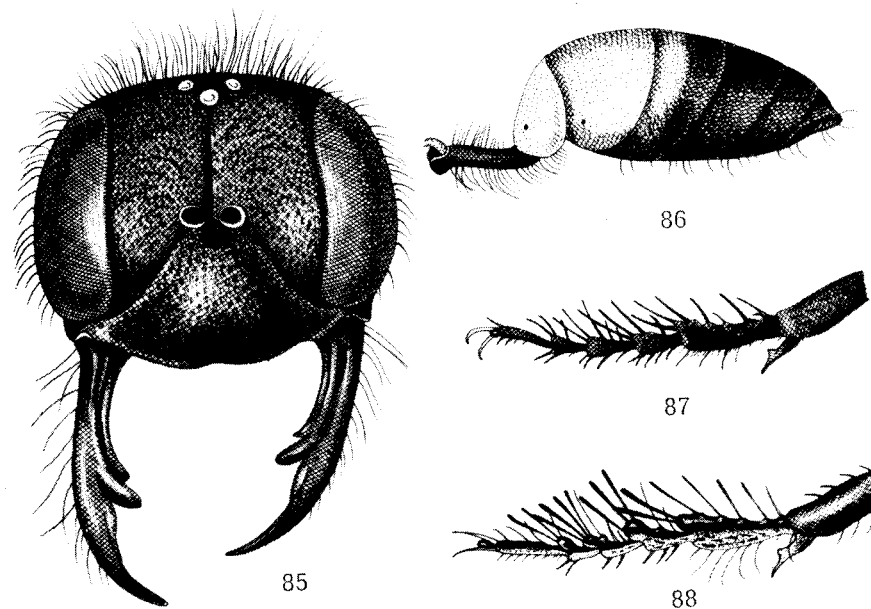

Fig. 85. Head in frontal view of *Podalonia luffii* Saunders, ♀.  
Fig. 86. Abdomen in lateral view of *Podalonia hirsuta* (Scop.).  
Figs. 87-88. Foretarsi of female *Podalonia*. - 87: *hirsuta* (Scop.); 88: *luffii* Saunders.

ion. Sides coarsely, somewhat irregularly striate. Second tergum entirely red or brownish-red. First tergum anteriorly with a black spot of varying size. Third tergum with narrow, black posterior border. Tarsal segments of forelegs comparatively strongly dilated. Pulvillus large. Claws with basal tooth.

Male: 13-18 mm. Clypeus comparatively short and broad, in profile distinctly concave behind anterior border. Area just in front of antennal socket not depressed as in *hirsuta*. The long pilosity on head and scutum is uniformly black, without admixture of pale hairs. Propodeum dorsally as in female with fine diagonally striate sculpture with interspersed granulation. First tergum with a black spot, which often covers the whole dorsal part. Second tergum usually entirely red, occasional specimens have an apical black, triangular spot. Posterior part of third tergum with a more or less extensive black area, which may extend forward in the shape of a triangular spot. Claws with distinct basal tooth.

A more southern species than *hirsuta*. - Denmark: rather common throughout the country. - Sweden: northern distribution limit runs through Vrm. and Gstr. - Norway: a few records from Ø, Aay and Ry. - Finland: very local, a few records from Ab and Sa. - In Soviet Karelia the species is known from Ib. - Widely distributed in the Palaearctic region.

The species often breeds together with *hirsuta*, but seems to be slightly more thermophilous. During excavation of the nest, small quantities of material are collected between the forelegs and the ventral side of the head. This material is carried some distance away from the entrance. As prey are used e.g. *Agrotis*-larvae (Lep. Noctuidae). In rare cases (small larvae) two are deposited in each cell.

##### 5. *PODALONIA LUFFII* Saunders, 1903

Figs. 85, 88.

*Podalonia luffii* Saunders, 1903: 248.

*Podalonia arenaria* Lüderwaldt, 1897: 125.

Female: 16-20 mm. Closely related to *hirsuta*. Head (fig. 85) in front view very broad, approximately rectangular. Clypeus strongly convex, with rounded, slightly undulating anterior border. Mandibles reddish-brown, very long, reaching to or even beyond articulation of opposite mandible. Head and thorax sculptured as in *hirsuta*. Pubescence, especially on pronotum and anterior part of scutum, with strong admixture of silvery hairs. Propodeum dorsally on average somewhat more weakly sculptured than in *hirsuta*, and with white pubescence. First, second and more than half of third tergum red. Metatarsus, and adjacent segment very strongly dilated. Tarsal pecten (Fig. 88) very strong. Pulvilli well developed.

Male: 15-18 mm. Head in front view almost as in *hirsuta*, but clypeus distinctly shorter and broader. In large individuals clypeus is distinctly convex. Area just below antennal sockets with a depression. Hairs on scutum, and also some of those on lateral areas of mesopleuron, long and slightly curled, with rich admixture of silvery-tipped hairs. Propodeum dorsally more weakly sculptured than in *hirsuta*. Colour of abdomen as in female. In a few cases the claws have a tiny basal tooth.

Denmark: WJ, Skallingen and Gammelgab; NWJ, Hansted. - Sweden: restricted to the southern coasts; Sk., Vitemölla, Löderup, Klammersbäck and Åhus; Hall., Harplinge, and Gtl., Ljungarn and Fårön. - Recorded primarily from littoral localities in Europe, i.e. along the coasts of the Atlantic Ocean, the Channel, the North Sea and on the southern coast of the Baltic Sea. The species is also recorded from the steppes in eastern Europe and Kazakhstan.

The species seems to prefer coastal drift-sand areas, which are not occupied by the other two Fennoscandian species of *Podalonia*. It might be a postglacial relict in Fennoscandia and Denmark.

## Genus *Ammophila* Kirby

*Ammophila* Kirby, 1798: 199.

Type-species: *Sphex sabulosus* Linné, 1758.

Large, very elongate, slender, red-and-black wasp (Fig. 89). Head large, wider than thorax, in anterior view often almost circular in females (Figs. 90, 91); distinctly elongate in males. Eyes very large, strongly convex. Antennae long, filiform. Clypeus large, its anterior margin evenly arched or slightly undulating. Its pilosity consists partly of long black bristles, which are most strongly developed in females, partly of a dense, silvery, felt-like pubescence, which is most developed in males. Mandibles long and powerful, inner side tridentate in females, shorter and more curved in males, with only a single tooth on the inner side. The labio-maxillary complex very elongate. Thorax and propodeum long and slender, propodeum dorsally with diagonally striate sculpture, often with interspersed granulation. Humeral tubercle, mesopleuron and posterior side of propodeum with white or silvery felt-like spots. Petiolus very long and thin, first tergum also very long (Fig. 92). Legs long and slender. Foretarsi of female asymmetrically dilated, with rather strong pecten. Tibia 2 with two spurs.

The species are associated especially with dry, sandy areas, where the nests are made in the ground. They consist of a short tunnel, which ends in a single

cell, and are provisioned with larvae of Lepidoptera or Hymenoptera Symphyta: Tenthredinidae.

Key to species of Ammophila

- 1 Third cubital cell sessile. Black colour on tip of abdomen with blue or greenish metallic sheen ..... 6. sabulosa (Linné)
- Third cubital cell petiolate. Black colour on tip of abdomen without metallic sheen ..... 2
- 2 (1) Long hairs on head in both sexes black. Propodeum with fine diagonally striate sculpture and granulation between striae, therefore of dull appearance. Male: first sternum black, first tergum red or red-yellow with a black spot covering the whole dorsal area. Second tergum with a large triangular black spot ..... 7. pubescens Curtis
- Long hairs on head of female yellowish, in male white. Dorsal side of propodeum with coarse, diagonally striate sculpture, without distinct granulation between striae, and therefore shining. Male: first sternum black, first tergum mainly red or red-yellow, dorsal side with a black spot at base. Second tergum usually uniform red or red-yellow ..  
..... 8. campestris Latreille

6. AMMOPHILA SABULOSA (Linné, 1758)

Figs. 89, 90, 92.

Sphex sabulosus Linné, 1758: 269.

Female: 16-24 mm. Head in anterior view distinctly broader than high, inner orbits almost parallel. In smaller individuals the head is relatively narrower. Anterior border of clypeus, especially in large specimens, with a small tooth on each side (Fig. 90). The very short, dense pubescence on lower part of face vestigial, only rarely with silvery lustre. Pilosity of head otherwise brownish. Of the three teeth on the inner side of the mandibles the central one is squarely truncate (Fig. 90). Pronotum and scutum dull, shallowly and rather sparsely punctate with pale pubescence. The diagonally striate sculpture on propodeal dorsum very variable, the strong carinae often more or less irregular. Petiolus (Fig. 92) black, first tergum mainly black, second tergum completely black, and basal part of third tergum red-yellow or red-brown coloured. Tip of abdomen with faint bluish or greenish metallic sheen, this may be missing in specimens from the northern-

most parts of the range of the species. Metatarsus 1 strongly dilated on the outer side. Tarsal pecten strongly developed.

Male: 14-19 mm. Inner orbits strongly converging ventrally. Eyes very large and strongly convex. Long hairs of head black or brownish. A sparse admixture of pale hairs may occur occasionally. Thorax sculptured and hairy as in female, but lacking the strongly silvery felt-like spot on mesopleuron. The diagonally striate sculpture on dorsal area of propodeum sometimes very irregular and indistinct. First tergum with a dorsal dark longitudinal stripe. Second tergum likewise red, but with an elongate, oval, dorsal spot. Only the anterior fourth of third tergum red. Tip of abdomen black with faint greenish or bluish metallic sheen.

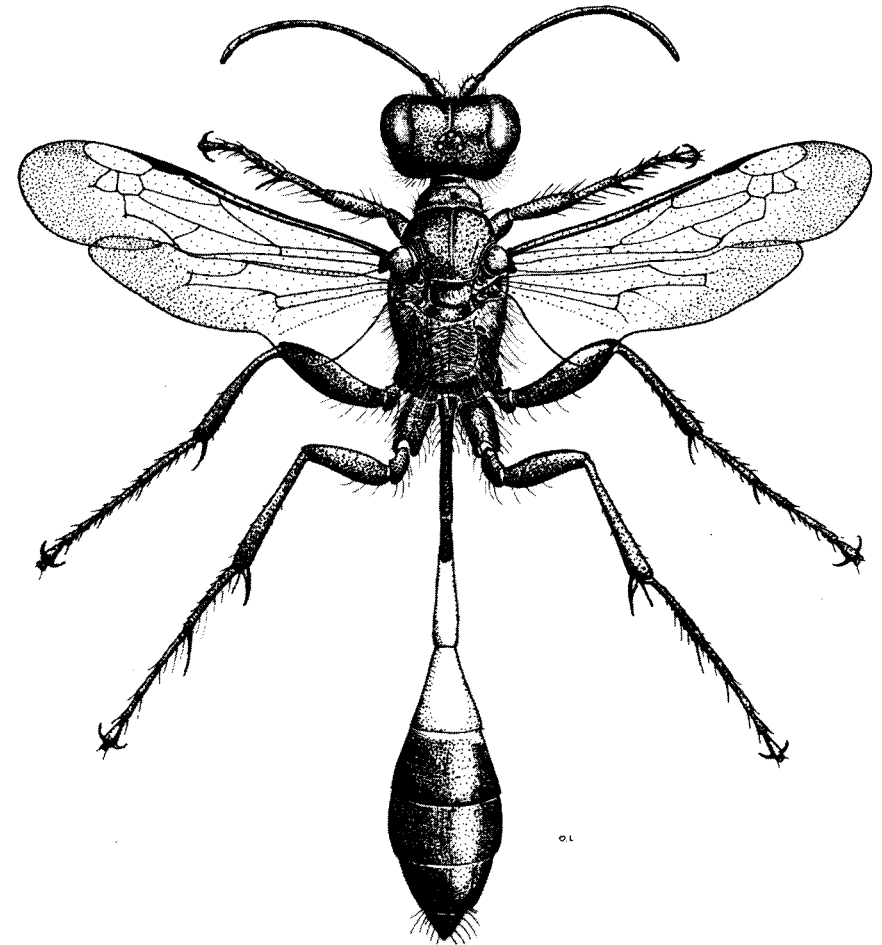

Fig. 89. Female of Ammophila sabulosa (L.). Length: 16-24 mm.

Very common in Fennoscandia and Denmark. Northern distribution limit runs through Nb. in Sweden, SFi in Norway and Ks in Finland. In Soviet Karelia recorded from Ib and Kr. - The species is widely distributed in the Palaearctic region, from northern Africa in the south, the Atlantic Ocean in the west, through southern Siberia to China, Kamchatka and Japan in the East.

The nests are usually constructed in a fairly horizontal, dry, sandy area, but steep, sandy or gravelly slopes may also be used. While the nest is being excavated, small quantities of sand or gravel are removed, carried between the ventral side of the head and the forelegs. Larger particles are released with the mandibles. The entrance of the nest attains a length of 5 to 20 cm and ends in a single larval chamber. The food consists of larger naked larvae of Noctuidae, Notodontidae or the like, e.g. Panolis piniperda Panz., Anarta myrtili L. and Notodonta sp. Each cell most often contains only a single larva. The paralyzed larva is often carried more than 20 m across uneven ground. During the journey the larva, which is held with the mandibles, is sometimes dropped, while the wasp either climbs or flies up on top of a stone, twig or the like, evidently for better orientation. The return to the nest thus takes place exclusively by the sense of sight. For the last few centimetres the olfactory sense is presumably of rather great importance. When the larva is placed in the cell and the egg laid, loose sand is scraped down into the entrance by means of the forelegs. The sand is stamped firmly together, often with the anterior side of the head. Finally the hole is closed with a stone of suitable size. The place is camouflaged with fir needles, pebbles and the like.

The imago is met with from the end of May to often late in September. Males emerge up to one week earlier than the females. The species, especially in Central Europe, is the host of Paraxenos sphecidarum Duf. (Strepsiptera). Larva described by Iida, 1969.

7. AMMOPHILA PUBESCENS Curtis, 1829

Fig. 91.

Ammophila pubescens Curtis, 1829: no. 672.

Ammophila susterai Šnoflák, 1943: 1.

Ammophila adriaansei Wilcke, 1945: 277.

Ammophila campestris var. alpicola Beaumont, 1945: 468.

Female: 15-19 mm. Head in front view as in Fig. 91. Clypeus with slightly projecting median lobe with rounded or obtuse-angled corners. Clypeus proper with distinctly silvery pubescence. Long hairs of head black. Median tooth of the three teeth on the inner side of mandibles rounded distally (Fig. 91), the first tooth may be very weak. Diagonally striate sculpture regular dorsally on propodeum, striae

straight. Interspaces with distinct granulation. First tergum mostly, second completely, and anterior quarter of third, red. Black tip of abdomen without metallic lustre. Metatarsus 1 weakly dilated on outer side, trochanter and femur ventrally with a row of strong black bristles. Second and third cubital transverse veins joining at the radial vein or before it, i.e. making third cubital cell petiolate.

Male: 13-17 mm. Long hairs of head black. Silvery pubescence on anterior part of face often collected in small downward tapering bundles so that the underlying cuticula becomes visible. Area just below antennal sockets slightly excavate. Propodeal sculpture as in female, but often more irregular. Whole dorsal side of first tergum black. A black triangular spot occupying most of dorsal face of tergum 2. Dorsum of third tergum black except for two larger or smaller triangular, red spots anteriorly. Tip of abdomen without metallic lustre.

The distribution pattern of this species is rather similar to that of A. sabulosa, but it is a more southern species. The northernmost records from Sweden are from Gstr. and Med. - Only a few records exist from Norway: VÅy, Mandal. -

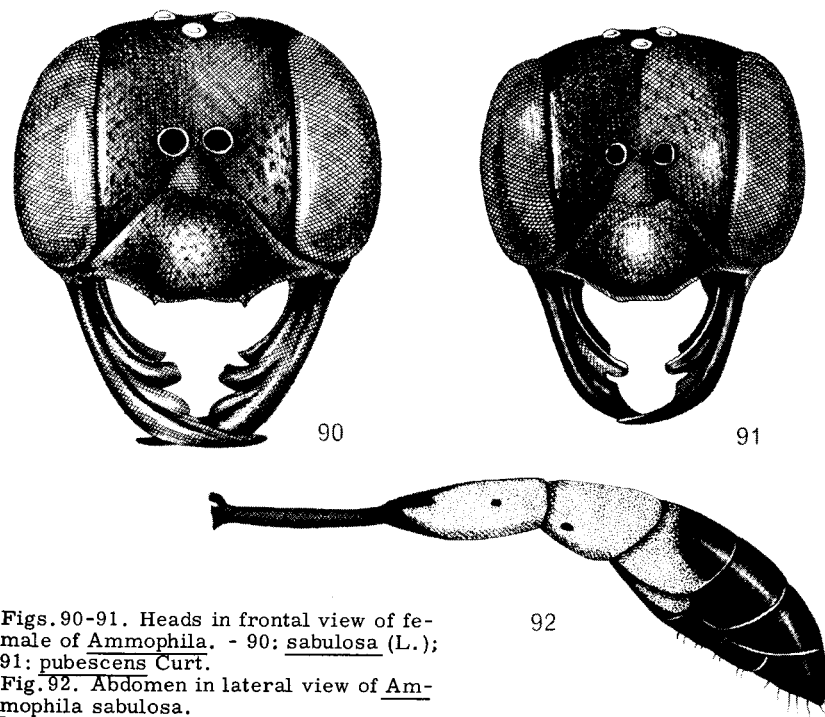

Figs. 90-91. Heads in frontal view of female of Ammophila. - 90: sabulosa (L.); 91: pubescens Curt.  
Fig. 92. Abdomen in lateral view of Ammophila sabulosa.

In Finland the northern distribution limit runs through Ok and ObS. In Soviet Karelia found in Ib and Kr. - The species is common through large parts of Europe, and also occurs in Mongolia.

The species may often be found nesting in the same localities as sabulosa. The female excavates the nest before hunting. Small quantities of material are collected and held between the forelegs and the ventral side of the head while being flown some distance away. When the larval cell has been finally provisioned, the entrance is temporarily closed with a loose sand plug. The prey usually consists of larvae of Geometridae (Lep.), but smaller larvae of Noctuidae may also be used. Exceptionally larvae of Tenthredinidae (Hymenoptera, Symphyta) are used. The prey is paralyzed and flown to the nest. Partly depending on the size of the prey each cell is provisioned with 3-10 larvae. The egg is deposited on the first placed prey, and the larva of the wasp may be far developed before the last prey has been deposited. The nest is carefully closed between each visit. The female will usually inspect her nest between each provisioning. Finally, the entrance is camouflaged with any available material. Metopia argyrocephala Meig. (Diptera, Miltogrammatidae) is recorded as inquiline, and Paraxenos sphecidarum (Duf.) (Strepsiptera) as parasite on imagines in South and Central Europe.

#### 8. AMMOPHILA CAMPESTRIS Latreille, 1809

Ammophila campestris Latreille, 1809, 4: 54.

Female: 11-17 mm. Closely related to pubescens. Distinguished from this (besides the characters mentioned in the key) by the denser silvery pubescence on the clypeus and by the long pilosity being absent from the basal part of the petiolus.

Male: 11-16 mm. Easily distinguished from pubescens by the often completely red second tergum. The first tergum has a dark spot of variable size. The silvery pubescence on the clypeus is evenly distributed, generally not collected in bundles.

This species is widespread and rather common in Denmark. - In Sweden it occurs rather frequently in the south (Sk. and Sm.), whereas the records from Ö1. and Dir. are very few. - Not recorded from Norway. - Finland: a few records from N, St, Om and ObS. Soviet Karelia: Ib, Kr. - The species is widely distributed in the Palaearctic region, but does not seem to be as common as pubescens. Towards the east the species reaches the Pacific.

In contrast to the other Nordic species of Ammophila this species exclusively uses larvae of Tenthredinidae (Hym., Symphyta). Its larva was described by Grandi (1926).

## SUBFAMILY PEMPHREDONINAE

A highly diverse subfamily, traditionally accepted to comprise two tribes, the Pempredonini and the Psenini. The species vary in size from about 2.5 mm in Spilomena to 13 - 15 mm in some Pempredon and Psen. It does not seem possible to point out an autapomorphism for the group which in several characters resembles the Sphecinae. The second apical spur on tibia 2 is, however, absent, and an oblique carina on coxa 2 is present. It is questionable, if an arboreal nesting habit is an original feature of the subfamily. The Pempredonini must be considered the more primitive of the two tribes, and I agree with Evans (1959a) that the Psenini probably had a pempredonine ancestor.

## TRIBE PEMPHREDONINI

The Pempredonini comprises the following Nordic genera: Pempredon, Ceratophorus, Diodontus, Passaloecus, Stigmus, and Spilomena and is characterized as follows: Inner orbits parallel or slightly converging ventrally. Frons without longitudinal or transverse carinae. Antennae filiform, inserted relatively low on frons. Labrum large. Humeral tubercles reaching the tegulae only in Spilomena. Petiolus formed by sternum 1 alone (abdomen sessile in Spilomena). Females primarily with a pygidial area. Tarsal pecten strongly reduced. Forewings primarily with two cubital and two discoidal cells, but especially in small species these numbers might be reduced. The spinneret of the larva is distinctly paired, although the openings might be connected by a narrow slit. The openings at the tip of two prolongations. Maxillae directed medially, the galea smaller than the maxillary palpus and might be vestigial. Mandibles short and broad, with four to six teeth (fewer in small species). Antennal papillae usually absent.

## Genus Pempredon Latreille

Pempredon Latreille, 1796: 128.

Cemonus Panzer, 1806: 186.

Dineurus Westwood, 1840: 81.

Type-species: Crabro lugubris Fabricius, 1793.

Entirely black, medium to rather small species (Fig. 43). Great morphological variation occurs mainly in the following characters: degree of development

of the head behind ocelli, clypeal pilosity, and number of mandibular teeth. As useful secondary sexual characters can also be mentioned the morphology of the pygidial area of the females and the morphology of the antenna and tarsus 2 of the males. Propodeum with species-specific, but extremely variable sculpture. The dorsal area is surrounded by a more or less strongly raised, broadly U-shaped pad, which may be invaded by the sculpture of the area cordiformis or of the lateral and posterior faces of propodeum. Usually this pad is dull and sculptured in Pemphredon s. str., whereas it often lacks sculpture in the subgenus Cemonus. Petiolus always distinctly longer than wide, with a strongly pitted, rugose or striate sculpture. Abdomen shining, as a rule without any sculpture. Tarsus 1 in females with at most a weak pecten. Forewings with two cubital cells, of which the first is about twice as long as the second.

Almost exclusively distributed in the temperate areas of the Holarctic region (Taiga-species). The genus comprises about 35 species of which about 15 occur in Europe.

The species nest in holes in wood, hollow plant stalks etc. The prey consists of Aphididae.

Due to the great intraspecific variation and rather complicated sculptural characters, which in many cases cannot be adequately described in words, correct identification of the species often presents great difficulties. However, in many cases the secondary sexual characters can be used as key characters. A rather large number of illustrations are included to facilitate the keys and aid identification. For identification of certain species it is highly desirable to have plentiful material for comparison. Traditionally the genus is regarded as comprising two well-defined subgenera, Pemphredon s. str. and Cemonus Jurine, but the taxonomical value of these is highly questionable.

Ceratophorus Shuckard is treated as a distinct genus, since morphological as well as biological characters clearly separate it from Pemphredon.

Key to species of Pemphredon (subgenera in brackets).

- 1 First discoidal transverse vein joins first cubital cell, second the second cubital cell (rarely interstitial). Third antennal segment 2.5 - 3 times longer than wide. Scutum usually dull, coarsely sculptured, anteriorly generally with distinct transversely rugose or striate sculpture (Pemphredon s. str.) ..

2

- First and second discoidal transverse veins join first cubital cell. Third antennal segment at most twice as long as broad. Scutum usually shining with more or less distinct punctation (Cemonus Jurine) ..... 9
- 2(1) Females ..... 3
- Males ..... 13
- 3(2) Anterior border of clypeus with two incisions, whereby three toothlike projections are formed (Fig. 104). Petiolus much shorter than first tergum .. 4
- Anterior border of clypeus with at most a single incision ..... 5
- 4(3) Pygidial area vestigial, or very narrow, with a sharp longitudinal keel (Fig. 118). Scutum shining, with scattered punctation ..... 11. lugens Dahlbom
- Pygidial area broad, surrounded by a projecting ridge or carina (Fig. 117). Scutum with distinct microsculpture, dull, finely and densely punctate. .... 13. fennicus Merisuo

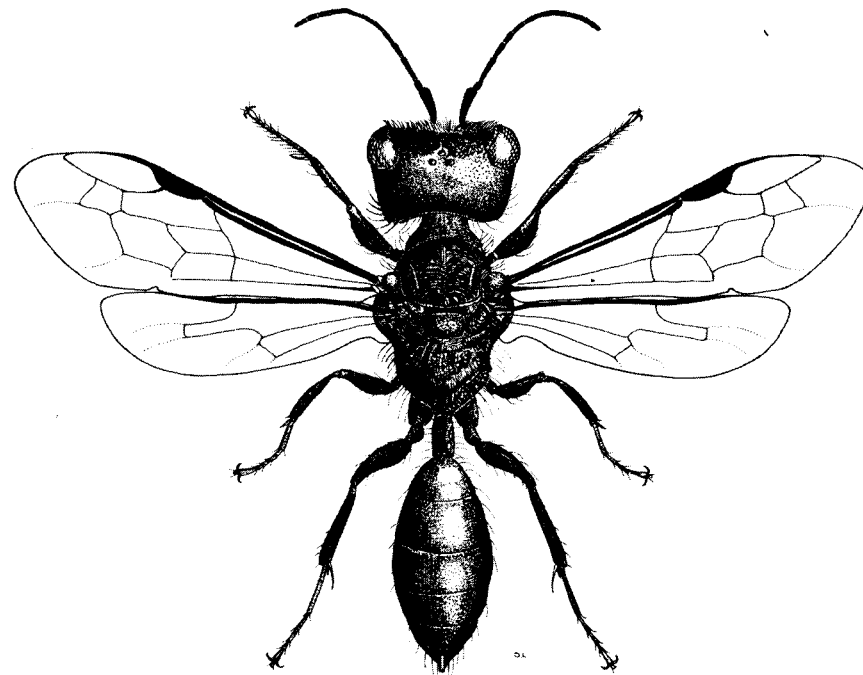
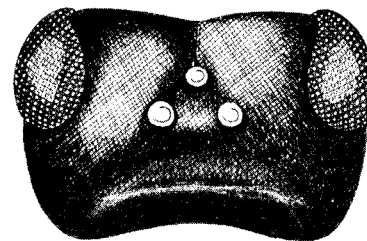
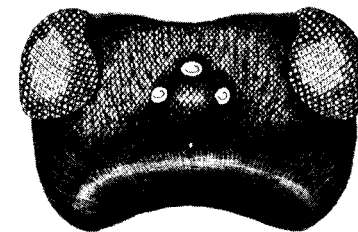

Fig. 93. Female of Pemphredon lugubris (Fabr.). Length: 9-12 mm.

- 5(3) The pad surrounding the irregularly rugose area cordiformis shining, with weak microsculpture. Pygidial area plane and delimited only by a weak carina (Fig. 114) ..... 15. balticus Merisuo
- The pad surrounding the area cordiformis distinct, often irregularly transversely rugose and dull. Pygidial area usually excavate apically and delimited by a sharp carina. If this is not the case (montanus), the anterior border of clypeus projects in an obtuse angle ..... 6
- 6(5) Centre of clypeus with a deep semicircular incision delimited on either side by a small tooth (Fig. 106) Pygidial area narrow, excavated in a groove apically ..... 12. flavistigma Thomson
- Anterior border of clypeus without incision, squarely truncate, weakly convex or slightly angularly projecting ..... 7
- 7(6) Pygidial area broad and flat (Fig. 116). Anterior border of clypeus angularly projecting (Fig. 102). Scutum with coarse fingerprint-like sculpture. 10. montanus Dahlbom
- Pygidial area narrower or groove-like, excavated at least apically. Anterior border of clypeus at most slightly convex. Sculpture of scutum weaker ..... 8
- 8(7) Head behind eyes strongly narrowed (Fig. 94). Third antennal segment only slightly more than twice as long as broad (Fig. 124) ..... 14. beaumonti Hellén
- Head strongly developed behind eyes (Fig. 96). Third antennal segment almost three times longer than broad (Fig. 122) ..... 9. lugubris (Fabricius)
- 9(1) Females ..... 10
- Males ..... 19
- 10(9) Anterior border of clypeus arcuate-emarginate in middle (Figs. 108, 109). Pygidial area excavated apically, sides slightly concave, sharply delimited, with two strong bristle-bearing pits subapically (Fig. 121). Space between these often takes the form of a small longitudinal keel ..... 11
- Anterior border of clypeus either flat and trun-



94



95

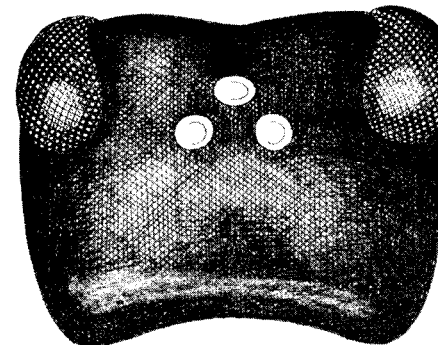

96

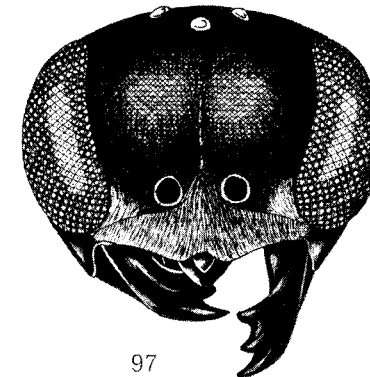

97

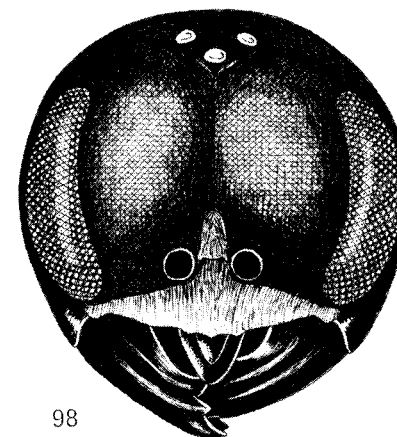

98

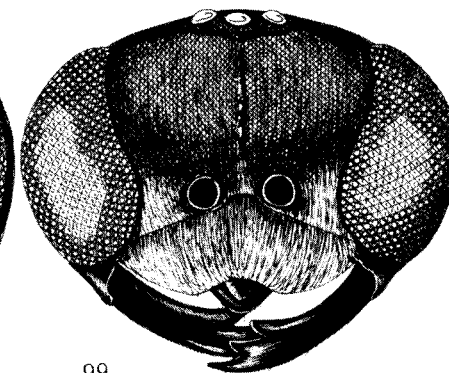

99

Figs.94-96. Heads in dorsal view of female Pemphredon. - 94: beaumonti Hellén; 95: balticus Merisuo; 96: lugubris (Fabr.).  
Figs.97-99. Heads in frontal view of Pemphredon. - 97: fennicus Merisuo, ♂; 98: same, ♀; 99: flavistigma Thomson, ♂.

- cate or angularly convex with parallel sides, never with a subapical keel (Figs. 119, 120) .. 12
- 11(10) Anterior border of clypeus with a broad, semi-circular emargination delimited on either side by a truncate tooth (Fig. 109). At the bottom of the emargination is often a weak tooth ..... 16. mortifer Valkeila
- Anterior border of clypeus with a quite small to vestigial incision (Fig. 108) ..... 17. wesmaeli (A. Morawitz)
- 12(10) Clypeus squarely truncate, often with a small projection in the middle (Fig. 112). Scutum with irregularly rugoso-striate sculpture. Sculpture on lateral and posterior faces of propodeum fine, transition between this and the shining pad gradual. 19. lethifer (Shuckard)
- Clypeus convex, anterior border strongly projecting (Fig. 111). The reticulate-rugose sculpture on lateral and posterior faces of propodeum coarse, transition between this and the shining pad sharp ..... 18. inornatus Say
- 13(2) Metatarsus 2 strongly S-shaped curved (Fig. 135). Dorsal carinae of propodeum regular, almost straight ..... 12. flavistigma Thomson
- Metatarsus 2 at most weakly curved. Dorsal carinae of propodeum very irregular, often anastomosing (except in lugens, which is easily recognizable by the shape of clypeus) ..... 14
- 14(13) Antennal segments 6 - 9 with strongly developed tyloidea, seen in profile as Fig. 126. Head and thorax with distinct microsculpture. Scutum with weak, sparse punctation. Propodeum weakly sculptured, pad shining ..... 13. fennicus Merisuo
- Tyloidea considerably less distinct. Head and thorax at most with weak microsculpture ..... 15
- 15(14) Pad surrounding area cordiformis shining, at most with indication of short rugae, with weak and scattered punctation (as in Cemonus). Third and fourth antennal segments of equal length (Fig. 127). Metatarsus 2 very slightly curved (Fig. 134) ..... 15. balticus Merisuo
- Pad surrounding area cordiformis dull, often

- strongly reduced due to the dense transverse striae. Third antennal segment longer than fourth 16
- 16(15) Area cordiformis strongly and regularly striate. Anterior border of clypeus with three weak teeth (Fig. 105). Petiolus very short (Fig. 131) 11. lugens Dahlbom

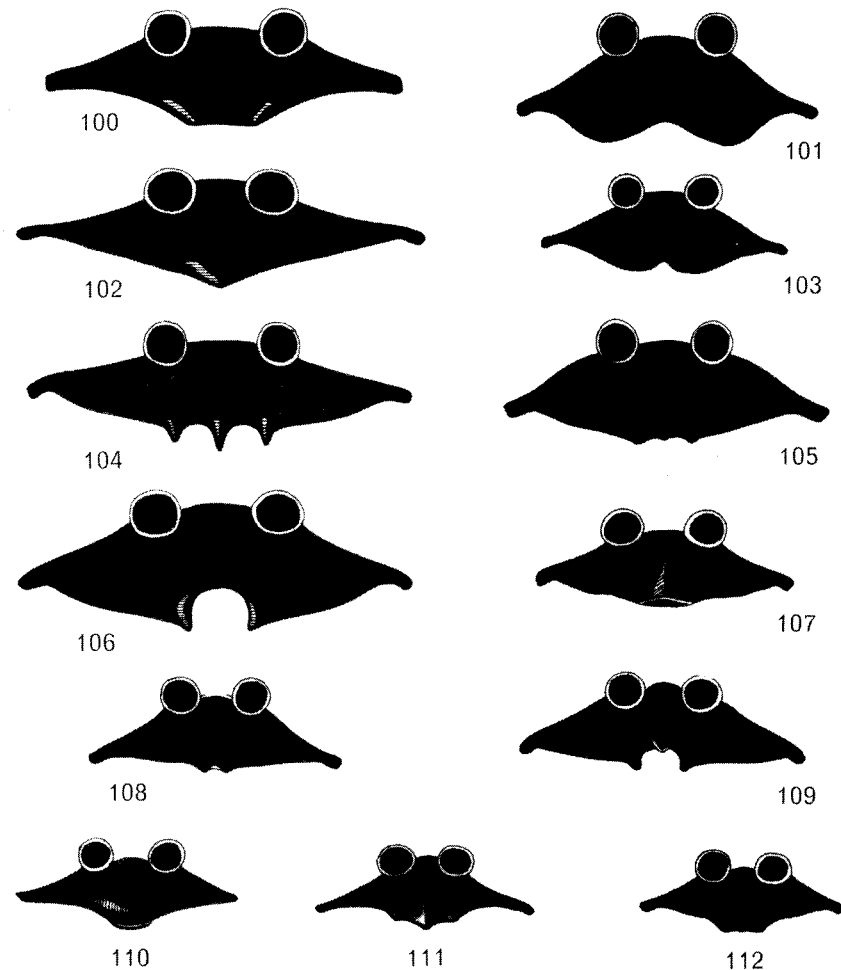

Figs. 100-112. Clypeus of *Pempredon*. - 100: lugubris (Fabr.), ♀; 101: same, ♂; 102: montanus Dahlbom, ♀; 103: same, ♂; 104: lugens Dahlbom, ♀; 105: same, ♂; 106: flavistigma Thomson, ♀; 107: balticus Merisuo, ♀; 108: wesmaeli (A. Mor.), ♀; 109: mortifer Valkeila, ♀; 110: beaumonti Hellén, ♀; 111: inornatus Say, ♀; 112: lethifer (Shuckard), ♀.



- Area cordiformis irregularly rugose. Anterior border of clypeus without teeth. Petiolus longer 17
- 17(16) Third antennal segment only slightly more than twice as long as broad (Fig. 125). Scutum shining, with strong punctation ..... 14. beaumonti Hellén
- Third antennal segment almost three times longer than broad. Scutum irregularly punctate and/or rugose ..... 18
- 18(17) Anterior border of clypeus with a quite small arcuate emargination (Fig. 103). Outside of tibia 3 with row of pale spines. Metatarsus 2 very slightly curved, twice as long as second tarsal segment (Fig. 133) ..... 10. montanus Dahlbom
- Anterior border of clypeus very broadly emarginate (Fig. 101). Tibia without spines on the outer side. Metatarsus 2 straight, more than twice as long as second tarsal segment (Fig. 132) ... 9. lugubris (Fabricius)
- 19(9) Flagellum ventrally without sharply delimited tyloidea, at most with swollen areas. Scutum very finely and sparsely punctate. .... 18. inornatus Say
- Middle segments of flagellum with sharply delimited tyloidea. Scutum with coarser and denser punctation ..... 20
- 20(19) At the bottom of the deep emargination in the anterior border of clypeus usually a small truncate tooth. Tyloidea as in Fig. 129 ..... 16. mortifer Valkeila
- Emargination shallower, evenly arcuate ..... 21
- 21(20) Tyloidea distinctly convex longitudinally (Fig. 130); can be strongly reduced in small specimens. The shining pad surrounding area cordiformis broad, only slightly invaded by the rugae from the area cordiformis. Posterior face of propodeum densely and rather strongly pitted ..... 19. lethifer Shuckard
- Tyloidea sharp, narrow, almost linear (Fig. 128). The pad surrounding the area cordiformis strongly reduced due to the invading rugae. Lateral and posterior face of propodeum coarsely reticulate-rugose ..... 17. wesmaeli (A. Morawitz)

9. PEMPHREDON (PEMPHREDON) LUGUBRIS (Fabricius, 1793)

Figs. 10, 93, 96, 100, 101, 113, 122, 123, 132.

Crabro lugubris Fabricius, 1793:302.

Pemphredon luctuosus Shuckard, 1837:197.

Pemphredon pacificus Gussakovski, 1932:8.

Female: 9-12 mm. Head (Fig. 96) strongly developed behind eyes, seen from above approximately rectangular. Clypeus (Fig. 100) plane, sparsely and somewhat irregularly punctate. Anterior border slightly projecting, weakly convex, almost squarely truncate. Punctation in front of ocelli dense and fairly coarse, punctures longitudinally fusing into a rugose sculpture. Vertex with scattered punctures, shining, with extremely weak and irregular micro-sculpture. Pilosity of head long, whitish. Antennae (Fig. 122) long and slender, third segment about three times longer than broad. Scutum on either side with irregular arcuate striation and weak interstitial rugosity. Mesopleuron in front of coxa 2 with a rather strong transverse striation. Area cordiformis with strong, very irregular costae on shining background. Pad surrounding the area densely and rather finely, transversely rugose, with a rather dull appearance. Pygidial area (Fig. 113) narrow, apically rather strongly excavate, delimited by a sharp carina. Tibia 3 on outer side with a row of short, dark spines.

Male: 7.5-10 mm. Head in front view very broad. Eyes strongly convex. Seen from above head strongly narrowed posteriorly. Clypeus (Fig. 101) with strong, dense, silvery pubescence, which covers the broad emargination in the anterior border. Antennae (Fig. 123) long and slender, third segment almost three times as long as broad, distinctly longer than fourth segment. Median flagellar segments with narrow, sharply delimited tyloidea. Sculpture and pubescence as in female. Scutum shining, with scattered, irregular punctation, only very seldom forming distinct rugae. Mesopleuron with transverse striation in front of coxa 2. Pad surrounding the strongly rugose area cordiformis normally with transverse striation, but especially in small individuals this may be almost vestigial. These specimens therefore may be very similar to beaumonti or balticus (see key to species). Petiolus longer than first tergum. Tibia 3 without spines.

Common and widely distributed in Fennoscandia and Denmark. Denmark: not found in WJ, NWJ and SZ. - Sweden: northern distribution limit in Hrj. and Jmt.; a few specimens from Ly. Lpm. - Norway: the species is rather common in the southern districts. A few records from NTi, Nnø and TR. - Finland: very common up to ObN and Ks. - Soviet Karelia: Ib and Kr. - Wide-

ly distributed throughout the Palaearctic region, eastwards to the Pacific Ocean.

The nests (Fig. 10) are most often gnawed in decayed deciduous wood, often in connection with existing tunnels of e. g. xylophagous Coleoptera. The nest consists of a branched system, in which the cells are situated in rows. Prey consists of larger aphids (Aphididae), e. g. wingless specimens of Aphis sambuci L. of which about 40 are placed in each cell. In a few cases two or more females have been observed using the same entrance. It is, however, only the first few centimetres of the main tunnel which is common. The species hibernates as a fully grown larva (pre-pupa) and emerges at the beginning of June. As hymenopterous parasitoids Perithous mediator and P. divinator (Pimplinae) are recorded. The larva was described by Janvier, 1961.

10. PEMPHREDON (PEMPHREDON) MONTANUS Dahlbom, 1845

Figs. 102, 103, 116, 133.

Pemphredon montanus Dahlbom, 1845: 262.

Female: 9-12 mm. Head seen from above strongly developed behind eyes (as in lugubris). Punctuation in front of ocelli very dense, rather coarse, especially laterally coalescing into a striate sculpture. Clypeus (Fig. 102) shining, angularly projecting in the middle. Rest of head dull due to the well developed microsculpture. Scutum with indistinct, large punctures, dull, especially posteriorly with dense, distinct fingerprint-like sculpture on either side of the midline. Mesopleuron dull in front of coxa 2, with sparse, weak punctuation. Area between base of forewings and the horizontally running coarsely pitted furrow on mesopleuron finely coriaceous. Pad surrounding the area cordiformis dull, densely and finely transversely rugose. Abdomen dull, with microsculpture. Pygidial area (Fig. 116) broad, almost plane and with distinct microsculpture. Surrounding carina only distinct apically.

Male: 8-10 mm. Very similar to lugubris, but distinguishable by the following characters: clypeus (Fig. 103) in the middle with a small arcuate emargination. Middle flagellar segments slightly swollen, ventrally with only short and indistinctly delimited tyloidea. Mesopleuron in front of coxa 2 without transverse striation. Petiolus distinctly shorter than first tergum. Metatarsus 2 weakly curved (Fig. 133).

Figs. 113-121. Pygidial areas of female Pemphredon. - 113: lugubris (Fabr.); 114: balticus Merisuo; 115: beaumonti Hellén; 116: montanus Dahlbom; 117: fennicus Merisuo; 118: lugens Dahlbom; 119: lethifer (Shuckard); 120: inornatus Say; 121: mortifer Valkeila.

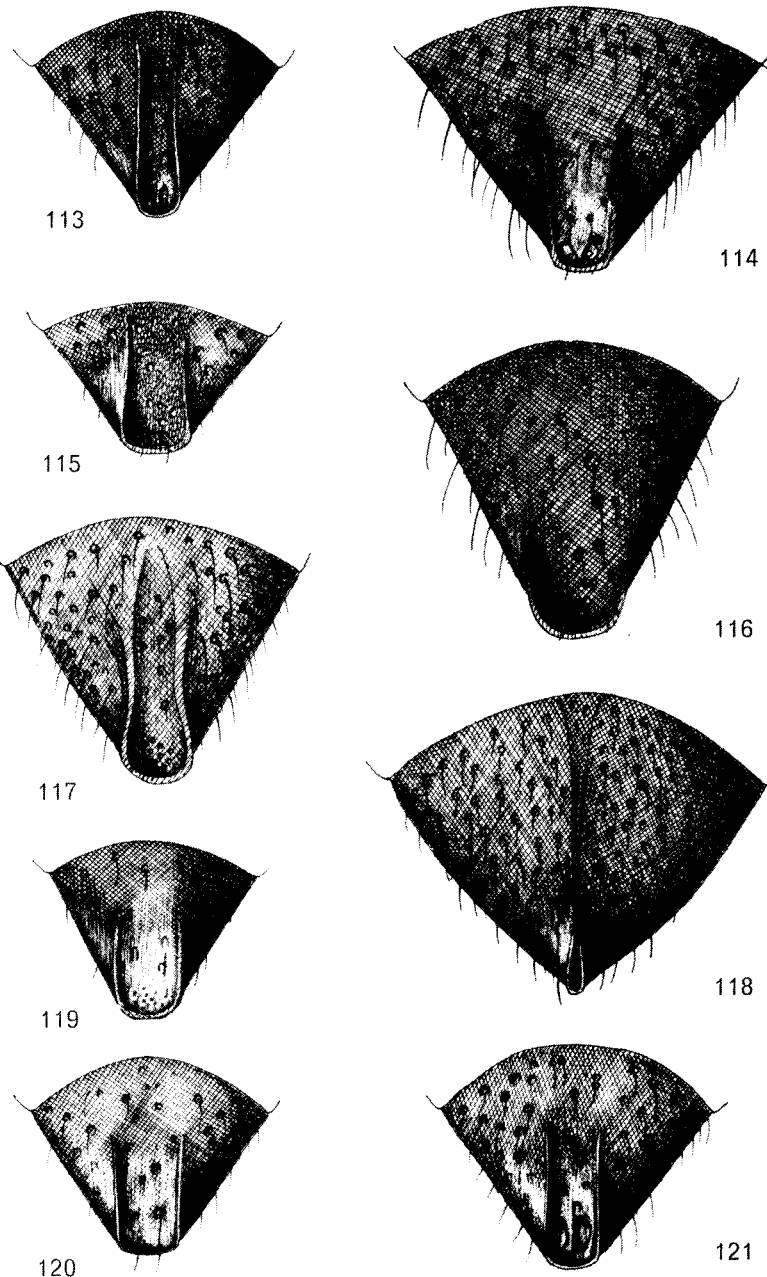

Very common in Fennoscandia, but absent in Denmark. - Sweden: the species seems to avoid coastal regions, at least in the southern parts. A typical boreal species. Northern distribution limit in Ly. Lpm. and Lu. Lpm. - Norway: only found in the northern districts: Nnø, Fi and Fn. - Finland: very common throughout the country from Al to LkW and Li. - In Soviet Karelia recorded from Ib and Kr. - A Holarctic species. Like lugubris, this species is widely distributed throughout the Palaearctic region, eastwards to Japan.

The tunnel system is often very complicated, since several females may use the same entrance.

11. PEMPHREDON (PEMPHREDON) LUGENS Dahlbom, 1842

Figs. 104, 105, 118, 131.

Pemphredon lugens Dahlbom, 1842: 76.

Female: 9-12 mm. Very easily recognizable species. Clypeus (Fig. 104) plane, shining, with two semi-circular emarginations between three sharp teeth. Scutum rather shining, distinctly punctate, without striation. Striae strong in area condiformis, fairly regular. Pad very indistinct, considerably invaded by striae. Petiolus (Fig. 131) very short, hardly twice as long as broad. Last tergum without typical pygidial area, with a sharply projecting longitudinal keel (Fig. 118).

Male: 8-10 mm. Anterior border of clypeus (Fig. 105) with two weak emarginations and three obtuse teeth. Scutum superficially punctate, shining. Striation on propodeal dorsum strong and very regular, often completely concealing the surrounding pad. Petiolus at most twice as long as broad, considerably shorter than first tergum.

One of the most common Pemphredon species in Fennoscandia. - Found in most Swedish districts up to Nb. - Finland: almost the same distribution as lugubris and montanus, northern distribution limit in LkW. - In Soviet Karelia this species occurs in Ib and Kr. - Not recorded from Norway, although it probably exists there. - Predominantly a montane species in Europe, common in the Alps and the Pyrenees.

Nest often constructed in connection with deserted tunnels in decayed wood. Prey consists of Aphididae, e. g. Aphis sp., of which 28-31 constitute provision for the larva. Egg is attached to one of the midmost aphids. Larva described by Janvier, 1961.

12. PEMPHREDON (PEMPHREDON) FLAVISTIGMA Thomson, 1874

Figs. 99, 106, 135.

Pemphredon flavistigma Thomson, 1874: 192.

Female: 11-13 mm. Large, robust species. Head strongly developed posteriorly. Frons with fine sculpture, consisting partly of coalescing punctures. Vertex with scattered, rather coarse punctation and distinct microsculpture, surface thereby exhibiting a weak lustre. Clypeus (Fig. 106) rather shining, with deep, almost semi-circular emargination in the anterior border. Third anten-

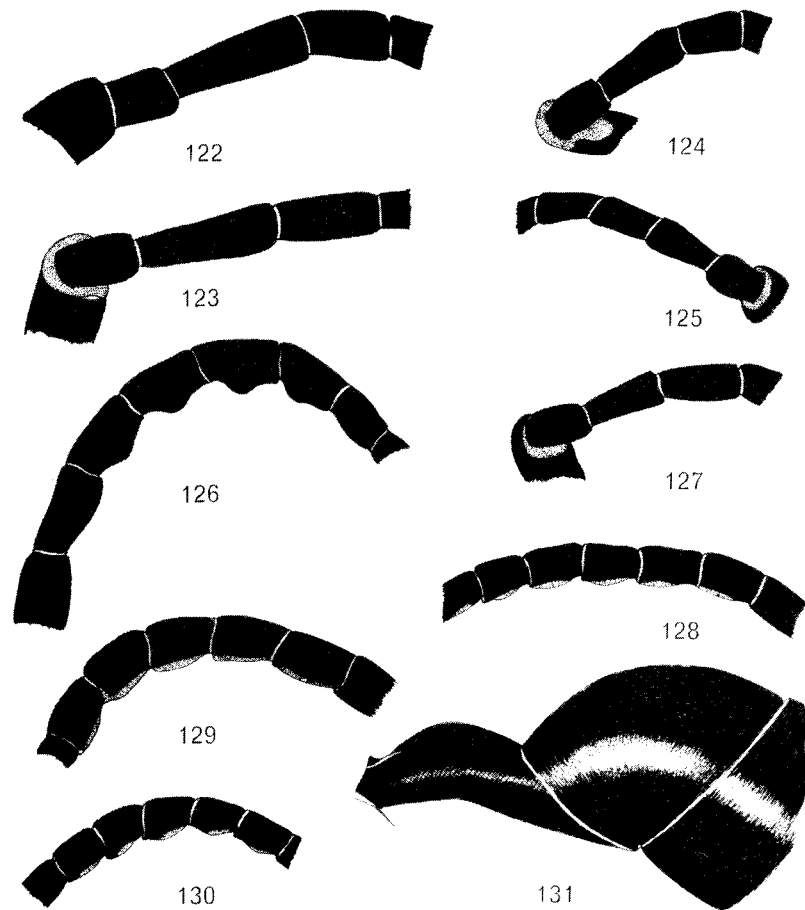

Figs. 122-130. Antennae of Pemphredon. - 122: lugubris (Fabr.), ♀; 123: same, ♂; 124: beaumonti Hellén, ♀; 125: same, ♂; 126: fennicus Merisuo, ♂; 127: balticus Merisuo, ♂; 128: wesmaeli (A. Mor.), ♂; 129: mortifer Valkeila, ♂; 130: lethifer (Shuckard), ♂.  
Fig. 131. Base of abdomen of Pemphredon lugens Dahlbom.

nal segment almost three times longer than broad. Sculpture of scutum coriaceous. Punctuation rather superficial and irregular, posteriorly partly coalescing longitudinally. The microsculpture consists of fine lines, especially distinct anteriorly. Scutellum rather coarsely punctate with distinct reticulate microsculpture. Mesopleuron anterior to coxa 2 rather shining, finely and somewhat sparsely punctate, with distinct microsculpture. Area cordiformis with strong, somewhat irregularly radiating striae. Pad finely and densely transversely striate. Posterior face of propodeum finely rugose. Petiolus weakly sculptured, as long as first tergum. Abdomen dull, distinctly microsculptured. Pygidial area narrow, excavated in a groove with coarse punctures. Wings strongly infumate.

Male: 9-11 mm. Head (Fig. 99) in frontal view very broad, eyes strongly convex. Frons in front of ocelli with rugose or granulate sculpture, behind ocelli punctate with fine transverse lateral striation. Clypeus concave, anterior border with broad, shallow, arcuate emargination. Third antennal segment almost three times as long as broad. Flagellar segments ventrally with dull, oval tyloidea. Scutum dull, with superficial, somewhat irregular punctuation. Scutellum densely punctate, interspaces densely rugose. Mesopleuron fairly shining with distinct punctuation and fine microsculpture. Area cordiformis with strong radiating costae. Pad surrounding the area finely and densely transversely rugose. Posterior face of propodeum irregularly rugose. Petiolus irregularly and very superficially sculptured, as long as first tergum. Abdomen distinctly microsculptured. Metatarsus 2 strongly curved, slightly dilated distally (Fig. 135). Wings strongly infumate.

A rare species in Fennoscandia. - Sweden: from central Småland to Hls. and Jmt. - Finland: from Al to a little north of the Polar Circle in ObN, Rovaniemi. - Soviet Karelia: Ib and Kr. - Widely distributed in the more temperate, continental parts of the Palaearctic region, eastwards to Japan.

The nests are constructed in decayed wood, e. g. Betula (Finland) and Morus (Japan). The tunnel system is branched, the inside diameter varies from 4.5 to 5.7 mm. The length of the larval cells varying from 6.5 to 14 mm, the partitions between the cells made of sawdust. 15-20 wingless aphids (Cinara sp., Tsuneki, 1952) constitute the provision. The species overwinters as a prepupa.

13. PEMPHREDON (PEMPHREDON) FENNICUS Merisuo, 1972

Figs. 97, 98, 117, 126.

Pemphredon fennicus Merisuo, 1972: 14.

Female: 10 mm. Head large, in front view as Fig. 97. Frons in front of ocelli punctate, without striation, interspaces with fine longitudinal lines. Area behind ocelli with distinct microsculpture, dull, punctate. Anterior border of clypeus with two weak emarginations, whereby three small teeth are formed (Fig. 97). Third antennal segment about 2.5 times longer than broad. Scutum and scutellum with superficial punctuation, but strong microsculpture. The furrows on mesopleuron vestigial or absent. Mesopleuron otherwise weakly punctate, dull. Area cordiformis with fine, dense, transverse undulating striae. Pad surrounding the area broad, slightly convex, rather shining, with fine transverse rugosity. Petiolus dorsally with a deep longitudinal furrow, very weakly sculptured, distinctly shorter than first tergum. Pygidial area (Fig. 117) with a distinct delimiting carina only around apex, rather broad, only slightly concave, apically with a group of hair-bearing punctures.

Male: 8 mm. Frons in front of ocelli coriaceous, dull. Behind ocelli distinctly and rather sparsely punctate, with strong reticulate microsculpture. Just behind posterior ocelli is a small swelling. Clypeus (Fig. 98) in middle with a rather narrow arcuate emargination. Third antennal segment hardly twice as long as broad. Middle flagellar segments with very well developed tyloidea, in profile as Fig. 126. Scutum very superficially sculptured, rather shining, because the microsculpture is weak. Sculpture of area cordiformis considerably weaker than in remaining species of Nordic Pemphredon s. str.

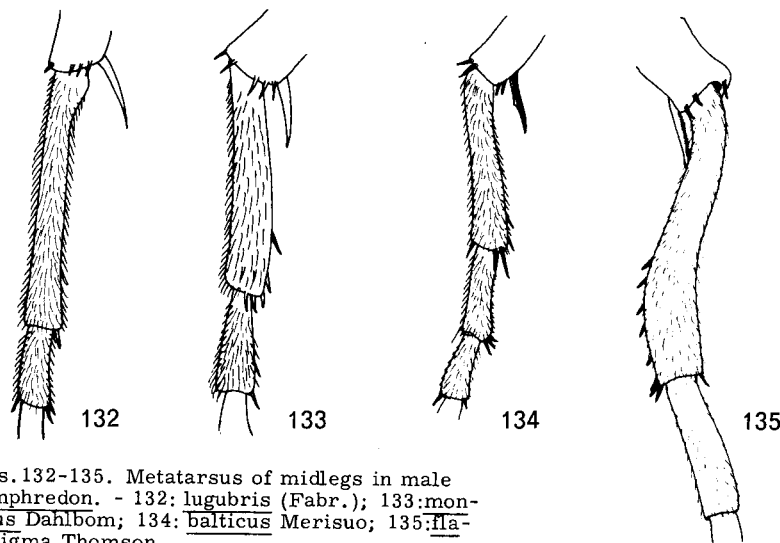

Figs. 132-135. Metatarsus of midlegs in male Pemphredon. - 132: lugubris (Fabr.); 133: mon-tanus Dahlbom; 134: balticus Merisuo; 135: fla-vistigma Thomson.

Pad surrounding area cordiformis shining, very slightly elevated. Posterior face and lateral parts finely granulate or coriaceous. Petiolus shorter than first tergum, dorsally with strongly depressed longitudinal furrow. Metatarsus 2 slightly curved, distinctly flattened on inner side.

This species is hitherto only known from the two type specimens (female and male), which both originate from the boreal coniferous forest zone in Lapland, Gargnäs, Ly. Lpm. in Sweden (male) and Suomussalmi, Ok in Finland (female).

Note. Fennicus is very closely related to the North American nearcticus Kohl. The variation within fennicus cannot be studied until more material is available, and the possible synonymy will not be discussed here. The distribution of the two forms suggests a separation during the glaciation in Pleistocene.

14. PEMPHREDON (PEMPHREDON) BEAUMONTI Hellén, 1955

Figs. 94, 110, 115, 124, 125.

Pemphredon beaumonti Hellén, 1955: 65.

Female: 7-8 mm. Head (Fig. 94) seen from above posteriorly strongly narrowed. Median lobe of clypeus thickened, rounded (Fig. 110). Frons in front of ocelli coarsely and densely punctate, and with indistinct longitudinal sculpture. Antennae (Fig. 124) short, third segment about twice as long as broad, only slightly longer than fourth segment. Scutum without actual punctation, but with coarse, irregular pit-like depressions, without striae. Scutellum likewise without striation. Mesopleuron in front of coxa 2 shining, with coarse punctures and very weak transverse rugae. The area cordiformis rather dull and very irregularly longitudinally rugose. The pad surrounding it with faint transverse rugae. Pygidial area (Fig. 115) comparatively broad, with distinct delimiting carina. Second and third sternum with scattered and rather coarse punctures. Metatarsus 1 ventrally with very short, weak and pale spines.

Male: 5.5-6.5 mm. Head densely and rather coarsely punctate. Clypeus with small, shallowly arcuate emargination in anterior border. Antennae (Fig. 125) short, third segment about twice as long as broad. Scutum shining, without striation but with dense, very coarse punctation. Mesopleuron in front of coxa 2 with very dense and rather strong punctation. Pad surrounding area cordiformis irregularly, transversely rugose. Petiolus short (as in balticus). Abdomen distinctly punctate. Metatarsus 2 on inner side and tibia 3 on outer side with a row of spines.

Very rare species in North and Central Europe, perhaps having a boreo-

montane distribution. In Fennoscandia a few specimens from Sweden: Gtl. and Finland: Ab and Sa. - In Soviet Karelia known from Ib.

Only a single nest has been recorded (Merisuo, 1972). This nest was found in a decayed pole, in which Calopus seraticornus L. (Col., Oedemeridae) was found. The nest produced 5 females and 2 males.

15. PEMPHREDON (PEMPHREDON) BALTICUS Merisuo, 1972

Figs. 95, 107, 114, 127, 134.

Pemphredon balticus Merisuo, 1972: 13.

Female: 8-11 mm. Very similar to small specimens of lugubris, but can be separated by the shining pad surrounding the area cordiformis. Anterior border of clypeus almost squarely truncate, rather strongly thickened, in front view forming a flat triangle (Fig. 107). Frons with fairly regular punctation with intermediate, very fine, oblique rugae. Head (Fig. 95) posteriorly distinctly narrowed. Part of scutum with irregular, rather coarse, pitted sculpture, part with fine, transverse, slightly arcuate rugae. Mesopleuron anterior to coxa 2 shining and smooth, with only few punctures and extremely fine transverse striation. Costae in area cordiformis irregularly undulating. Petiolus seen from above comparatively short. Pygidial area (Fig. 114) broad but rather indistinct, only apically with delimiting carina; its punctation weak.

Male: 6-10 mm. Very similar to small specimens of lugubris, from which it can be distinguished by the following characters: pad surrounding area cordiformis shining, only slightly invaded by costae from the latter. Third and fourth antennal segments of equal length (Fig. 127). Petiolus shorter than first tergum (1:1.1). Metatarsus 2 as Fig. 134, twice as long as second tarsal segment.

The species occurs very sporadic in Sweden: Hall., Sm., Ög. and Upl., and Finland: Al, Ab, N and Ta. - Otherwise very scattered in Europe (Poland, Germany, and Holland).

Known to breed in dead branches of Sambucus racemosa.

16. PEMPHREDON (CEMONUS) MORTIFER Valkeila, 1972

Figs. 109, 121, 129.

Pemphredon mortifer Valkeila, in Valkeila & Leclercq, 1972: 697.

Female: 8-10 mm. Head behind ocelli strongly developed. Anterior border of clypeus (Fig. 109) usually very characteristically shaped, since in the deep emargination there is a small tubercle or tooth. Emargination always broader

than width of scapus. Frontal keel very short or absent. Scutum with coarse, somewhat irregular punctation, which - especially in the anterior third - may have a tendency to form weak transverse rugae. Punctation on anterior two-thirds of scutum dense, interstices equal to or less than their diameter. Pubescence distinct over the whole surface. Area cordiformis distinctly depressed, rugae strong and slightly irregular, locally connected by transverse rugulae. Delimitation between shining pad and the coarsely reticulate-rugose sculpture on posterior face of propodeum sharp. Lateral margins of pygidial area (Fig. 121) slightly concave subapically, surface here with two large grooves, by which a more or less distinct median longitudinal keel is formed.

Male: 6-8 mm. Very similar to wesmaeli, but always recognizable by the shape of clypeus. The strong emargination is almost always provided with a small truncate tooth or tubercle. Median flagellar segments as Fig. 129. Frontal keel usually distinct. Scutum with coarse and rather dense punctation, occasionally with shining impunctate areas. Posterior face of propodeum coarsely reticulate-rugose. The shining surrounding pad occasionally reduced, owing to the very strong rugae of the area cordiformis. Second to fifth sterna with depressed apical margins.

Rather limited material exists from Denmark: NEZ, F and EJ. - Sweden: scattered occurrence from Sk. in the south to Ly. Lpm. in the north. - Not known from Norway and Finland, but occurs in Soviet Karelia, Ib and Kr. - The species is recorded from Central, East and North Europe. Additional material exist from Japan, Korea and Sakhalin; this material might constitute a separate subspecies.

The nests are constructed in timber and can have a complicated branching system. Each side branch normally terminates with a single cell, only in a few instances are there two in each of them. The number of cells varies considerably (max. 22), but it seems probable that the nest systems are composed of a number of smaller systems, constructed by several females (Tsunekki, 1952). The larva was described by Janvier, 1960. Omalus auratus (Linne) (Hymenoptera, Chrysididae) is recorded as a parasitoid.

17. PEMPHREDON (CEMONUS) WESMAELI (A. Morawitz, 1864)  
Figs. 108, 128.

Cemonus wesmaeli A. Morawitz, 1864: 459.

Sphex unicolor Panzer, 1798: H. 52, T. 24 (preocc.).

Pemphredon scoticus Perkins, 1929: 55.

Female: 8-10 mm. Vertex strongly developed. Clypeus (Fig. 108) flat, anterior border with small arcuate emargination, at most as wide as scapus. Frontal keel short or absent. Punctation of scutum very variable, but always well developed. Punctures dense, coarser than those of vertex, often coalescing into transverse rugae anteriorly. Distance between punctures usually as great as or less than the diameter of these. Pilosity distinct, rather strongly developed, distributed over whole surface. Rugae in area cordiformis strong and irregular, especially centrally, where they partly invade the shining pad. Posterior face of propodeum coarsely reticulate-rugose. Transition to pad often sharp. Pygidial area slightly constricted sub-apically, here with two large pits, each containing 1-3 bristle-bearing punctures. Second sternum distinctly punctate, punctures deeper than on following sterna.

Male: 7-9 mm. Can easily be confused with mortifer. Median flagellar segments with distinct tyloidea (Fig. 128). Emargination on anterior border of clypeus, however, always slighter, and always lacking the small tubercle at the bottom. The sculpture of scutum very variable, usually consisting of coarse punctures. Propodeum coarsely reticulate. The shining pad surrounding the very strong rugae of the area cordiformis often almost intersected by these in such a way that only a narrow margin is left. Posterior margins of second to fifth sternum distinctly depressed.

Denmark: a female from NEZ, Tisvilde Hegn. - Sweden: from Sk. in the south to Nb. in the north, not uncommon. - Norway: very little material from SFi, Flesje and Ri, Lerhang. - Widely distributed in Finland, from Al, Ab, and N in the south to Kb and Ks in the north. - Soviet Karelia: Ib and Kr. - Widely distributed in the temperate Palaearctic region.

The nests are constructed in decayed timber or pith-filled stems of e. g. Artemisia. The tunnel system is branched, often each side branch ending only with a single cell. Provision consists of Aphididae, e. g. Aphis, Myzus, Anuraphis, Macrosiphum or Atheroides. The larva was described by Janvier, 1960.

18. PEMPHREDON (CEMONUS) INORNATUS Say, 1824  
Figs. 111, 120.

Pemphredon inornatus Say, 1824: 339.

Pemphredon shuckardi A. Morawitz, 1864: 460.

Female: 5-8 mm. Head seen from above comparatively short. Middle of clypeus (Fig. 111) strongly convex, anterior border angularly projecting. Punctation of scutum weak and sparse, on posterior two-thirds drawn out

into very weak longitudinal furrows. Pilosity thin, often only visible on anterior half of scutum. Punctuation of scutellum likewise weak, extended into longitudinal furrows. Rugae of area cordiformis irregular. Often the stronger longitudinal rugae are connected by transverse rugulae. The shining surrounding pad well developed, often deeply invaded centrally by the rugae of the area cordiformis. Posterior face of propodeum coarsely reticulate-rugose. Transition between this and the shining pad very distinct. Pygidial area (Fig. 120) with parallel sides, with a few, weak, hair-bearing punctures apically. The surface itself shining, with only very few punctures. Second sternum very sparsely and finely punctate.

Male: 5-7 mm. Antennae without sharply delimited tyloidea, at most with slight swellings. In front of the anterior ocellus a sharp longitudinal keel often is found. Scutum smooth and shining with very scattered, fine punctuation. Punctures much weaker than those of vertex. Scutellum with sparse but deeper punctures, and shining interstices. Propodeum as coarsely sculptured as in female. Posterior borders of sterna not depressed.

A common and widespread species in Fennoscandia and Denmark. Northern distribution limit not far from the Arctic Circle in Sweden and Finland. - Norway: a few records from Ø and AK. - Widely distributed throughout the Palaearctic region, eastwards to Mongolia, Japan and Kamchatka. In North America east of the Rockies.

The species breeds sometimes in branches and old wood, sometimes in galls of Lipara (Dipt., Chloropidae) on Phragmites. The prey consists of Aphididae, e.g. Phorodon, Aphis, Macrosiphum, Myzus, Thelexes, Amphorophora, Anuraphis, Pterocomma, Chaitophorus, Pterocallidium, and Callipterus. Occasionally isolated individuals of a second generation are seen in the middle of September. As a hymenopterous parasitoid is recorded Perithous divinator Rossi (Pimplinae).

19. PEMPHREDON (CEMONUS) LETHIFER (Shuckard, 1837)

Figs. 112, 119, 130.

Cemonus lethifer Shuckard, 1837: 201.

Pemphredon littoralis Wagner, 1918: 143.

Pemphredon fuscatus Wagner, 1918: 143.

Pemphredon neglectus Wagner, 1918: 143.

Pemphredon minutus Wagner, 1918: 143.

Pemphredon brevipetiolatus Wagner, 1931: 232.

Female: 6-8.5 mm. Clypeus (Fig. 112) plane, only the anterior border proper slightly reflected, almost squarely truncate. Scutum with rather coarse, dense punctuation, which rarely coalesces to form weak transverse rugae. The punctures sharply delimited anteriorly, posteriorly tapering into the interspaces, punctuation almost as strong as that of vertex. Pilosity of scutum weak, visible only in anterior half. Sculpture of posterior face of propodeum dorsally continuing evenly into the shining pad surrounding the area cordiformis. Rugae of area cordiformis strong and regular, usually without transverse connections. Pygidial area (Fig. 119) with parallel sides, with 4-8 extremely small hair-bearing punctures subapically. Second sternum distinctly punctate.

Male: 5-8 mm. Antennae with characteristic tyloidea (Fig. 130). Keel in front of anterior ocellus very short or replaced by a weak longitudinal furrow. Punctuation of scutum very variable, usually as in female. Occasionally the punctuation is considerably sparser, but in that case more distinct. Propodeum as in female, but rugae of area cordiformis more irregular. Second sternum distinctly punctate. Posterior borders of sterna 2-5 distinctly depressed.

The species is common all over Denmark. - Sweden: rather common in the south, northern distribution limit through Vrm. and Gstr. - Norway: an isolated occurrence in the south-western part. - Finland: only found in the south-western districts. Soviet Karelia: Kr. - Distributed over large areas of the Palaearctic region, eastwards to Japan. Recently introduced to North America (Krombein & Burks, 1967).

The species prefers to nest in stems of different species of Rubus, sometimes also in wood, or in galls of Lipara lucens (Dipt., Chloropidae) in Phragmites. The construction is dependent partly on the diameter of the stem, thus in thicker stems a branched system may be made. The prey consists of various species of aphids (Aphididae), but each nest is mainly provisioned with a single species. The larva was described by Janvier, 1961; Grandi, 1961; Evans, 1964 and Iida, 1969. As a rule the species has only a single generation, but isolated individuals may have a second generation in September. It is scarcely possible for these to provision new nests. Several hymenopterous parasitoids are recorded (See Danks, 1971).

Note: The extensive list of synonyms suggests a considerable intraspecific variability. The variation is, however, rather continuous with respect to each character, and neither geographical nor biological criteria seem to indicate the existence, either of more species or of subspecies.

## Genus *Ceratophorus* Shuckard

*Ceratophorus* Shuckard, 1837: 195.

Type-species: *Pemphredon morio* van der Linden, 1829.

The genus was long treated as a subgenus of *Pemphredon*, but I find it most appropriate to refer its only two species to a distinct genus on the ground of morphological and biological criteria.

Head in front view (Fig. 137) very broad, between antennal sockets a strongly projecting process. Clypeus (Fig. 138) with a very deep emargination, on either side delimited by a rounded tooth. Mandibles narrow, in female bidentate, in male tridentate. Antennae short, third segment only slightly longer than fourth. Labrum very large, projecting like a tongue. Scutum smooth and shining, only anteriorly with distinct punctation. Area cordiformis strongly rugose, surrounded by a shining pad. Petiolus very short, only slightly longer than broad. Females with almost plane pygidial area (Fig. 139, 140). Males lack the dense, silvery pubescence on clypeus. Forewings with two cubital cells, each of them joined by a discoidal transverse vein. The males can be extremely difficult to identify correctly.

The species breed in wood. In contrast to most *Pemphredon*-species the full-grown larva spins a complete cocoon. The prey consists of wingless aphids.

### Key to species of *Ceratophorus*

- 1 Female: emargination in middle of clypeus evenly rounded (Fig. 137). Process between antennal sockets with distinctly concave sides, broadest subapically. Pygidial area distinctly excavate, delimited by a sharp carina (Fig. 139). Male: larger, 6-7.5 mm. Head comparatively narrow ..... 20. *morio* v. d. Linden
- Female: emargination in middle of clypeus with weak projection (Fig. 138). Process between antennal sockets with parallel sides. Pygidial area very slightly excavate, its delimiting carina weak (Fig. 140). Male: smaller, 4.5-5.5 mm. Head comparatively broad ..... 21. *clypealis* Thomson

20. *CERATOPHORUS MORIO* (van der Linden, 1829)

Figs. 136, 137, 139.

*Pemphredon morio* van der Linden, 1829: 82.

*Ceratophorus anthracinus* Smith, 1851: 126.

*Pemphredon carinatus* Thomson, 1870: 236.

Female: 7-9 mm. Head (Fig. 137) densely and strongly punctate. Punctures in front of ocelli coalescing into a rugoso-punctate sculpture. Emargination in anterior border of clypeus smooth at the bottom, without a tubercle. Frontal process strongly developed, its sides concave, apex often with a small emargination. Pygidial area longer than broad (Fig. 139).

Male: 6 - 7.5 mm. As female, but smaller. Emargination in anterior border of clypeus with a small tubercle in middle. Sterna with a rather dense fringe of yellowish hairs.

A rather sporadic species, locally often frequent. Denmark: only in North Zealand. - Sweden: several localities from Sm. in the south to Vg. in the north. - Norway: a single specimen from AK, Oslo. - Finland: from Al,

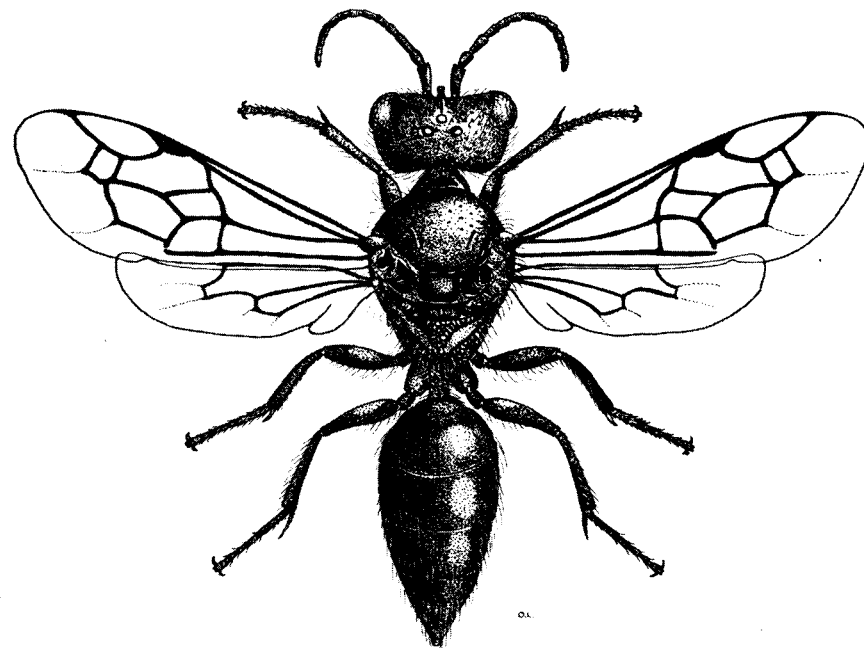

Fig. 136. Female of *Ceratophorus morio* (v. d. Lind.). Length: 7-9 mm.



Ab, and N in the south to ObS and Ks in the north. - Soviet Karelia: Ib and Kr. - Widely distributed in Europe.

The nests consist of a branched tunnel system, where each side branch ends in a cell. The provision consists of aphids, e.g. *Amphorophora* and *Anuraphis*. The egg is deposited on the ventral side of one of the first caught aphids. The full-grown larva spins a comparatively firm cocoon, in which there are no remains of aphids. See also Janvier, 1961.

21. *CERATOPHORUS CLYPEALIS* (Thomson, 1870)  
Figs. 138, 140.

*Pemphredon clypealis* Thomson, 1870: 236.

Very similar to *morio*, and only separable from this by the characters mentioned in the key. The female occasionally lacks the small tubercle at the bottom of the emargination in clypeus (Fig. 138).

Not as common as *morio*, and even with a more sporadic distribution. - Denmark: a few specimens from F and NEZ. - Sweden: Sk., Gtl., Ög. and Upl. - Finland: local in the southern districts. Also material from Kb and Ks. - In the Soviet Karelia known from Ib. - Widely distributed in Europe.

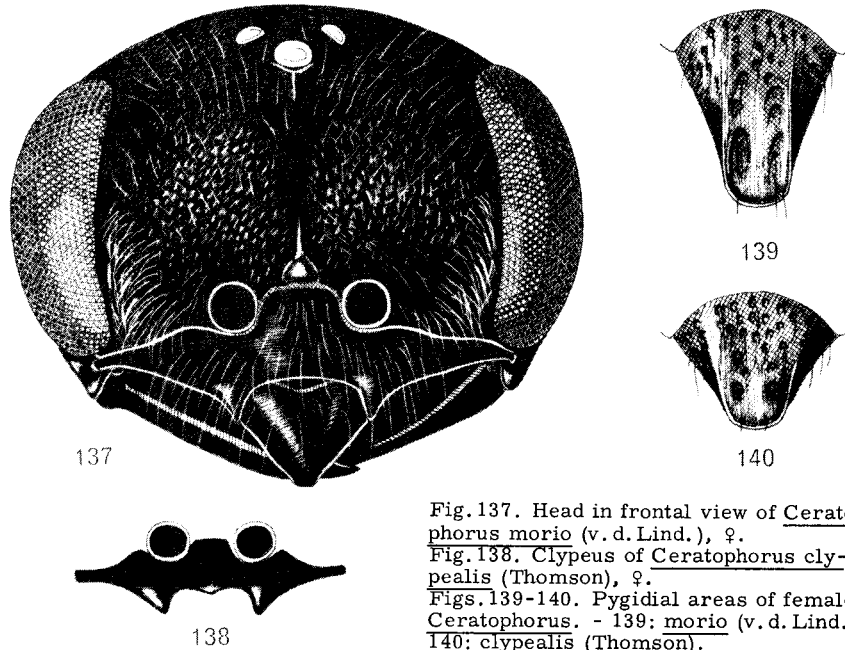

Fig. 137. Head in frontal view of *Ceratophorus morio* (v. d. Lind.), ♀.  
Fig. 138. Clypeus of *Ceratophorus clypealis* (Thomson), ♀.  
Figs. 139-140. Pygidial areas of female *Ceratophorus*. - 139: *morio* (v. d. Lind.); 140: *clypealis* (Thomson).

Found breeding in a dead apple-tree, also in abandoned beetle tunnels in beams in a house (Lomholdt, 1973). Remains of aphids are often attached to the surface of the cocoon.

## Genus *Diodontus* Curtis

*Diodontus* Curtis, 1834: 496.

*Xylocelia* Rohwer, 1915: 243.

Type-species: *Pemphredon tristis* van der Linden, 1829.

Medium to small species (Fig. 141), which in habitus and mode of locomotion can be very similar to the species of *Passaloecus*. The head is large and broad, in the female the distance between the mandibular articulations is greater than the distance between the eyes posteriorly, in the male considerably smaller. Clypeus of female shining, anterior border with two strong emarginations, whereby three sharp teeth are formed, the middle usually slightly weaker than the lateral ones. Clypeus of male covered by very dense, silvery pubescence. Emargination of anterior border simple. Forewings with two cubital cells, of which the first is more than twice as long as broad. The

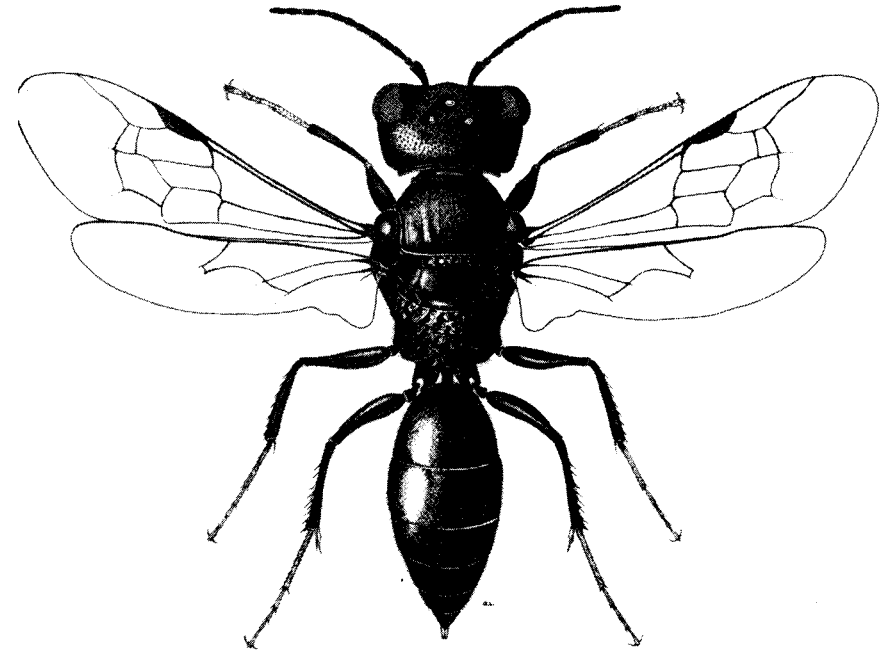

Fig. 141. Female of *Diodontus tristis* (v. d. Lind.). Length: 6-8 mm.

two discoidal transverse veins each join a cubital cell. Propodeum very coarsely sculptured. Petiolus very short. Tibiae 2 and 3 on the outer side with strong spines, which, however, may be very weak in males. Males as well as females with pygidial area.

The nests are constructed in the ground in sandy localities. The prey consists of aphids. The genus is distributed throughout most of the world. A great number of species occur in Central Asia (Tsuneki, 1972).

Key to species of Diodontus

Females

- 1 Along inner orbits runs a dull, impunctate furrow. Microsculpture between the dense punctures of frons consisting of irregular, weak rugae. Larger species ..... 2
- Along inner orbits runs a shining, impunctate, posteriorly more strongly raised, pad. Microsculpture between the sparse punctures of frons usually distinct, consisting of reticulate lines. Smaller species ..... 3
- 2(1) Scutum densely, finely, uniformly punctate. Scutellum and metanotum also densely punctate. 26. medius Dahlbom
- Anterior half of scutum very densely and rather coarsely punctate, punctures of unequal size. Posterior part shining with very scattered, rather coarse punctures. Scutellum and metanotum shining, with very scattered punctation ..... 25. tristis (v. d. Linden)
- 3(1) Mandibles and humeral tubercle black or brown-black. Tibiae black, tibia 1, however, with a pale line along anterior border ..... 24. luperus Shuckard
- Mandibles and humeral tubercle yellow. Tibiae brown-yellow ..... 4
- 4(3) Anterior border of clypeus as Fig. 142. Frons densely punctate. Ocelli form almost a right angle (Fig. 143) ..... 22. minutus (Fabricius)
- Anterior border of clypeus as Fig. 144. Frons sparsely punctate, microsculpture rather weak. Ocelli form a distinct obtuse angle (Fig. 145) ..... 23. insidiosus Spooner

Males

- 1 Flagellum entirely dark, without excavations. Larger species ..... 2
- Flagellum ventrally yellow-spotted or with slightly oblique excavations on 6th - 11th segments ..... 3
- 2(1) Frons coriaceous. Punctuation dense, interspaces with very fine, dense, slightly undulating rugae. Scutum, scutellum and metanotum evenly, rather densely and finely punctate ..... 26. medius Dahlbom
- Frons with coarse, dense, often coalescing punctures. Interspaces between punctures shining, with only indicated rugae. Scutum shining with scattered and coarse punctation. Scutellum and

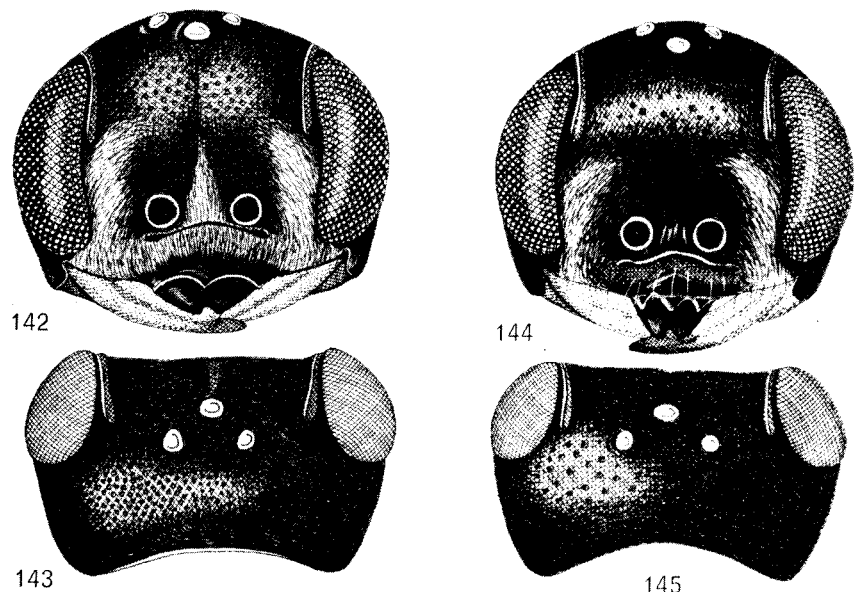

Figs. 142-145. Heads in frontal (142, 144) and dorsal (143, 145) views of female Diodontus. - 142, 143: minutus (Fabr.); 144, 145: insidiosus Spooner. Figs. 146, 147. Diodontus minutus (Fabr.). - 146: midtarsus; 147: foretarsus.

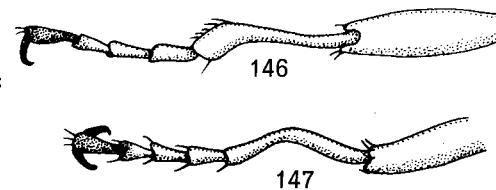

- metanotum with only extremely fine, scattered  
punctuation ..... 25. tristis (v.d. Linden)
- 3(1) Metatarsi 1 and 2 very long and slender, not  
dilated apically or S-curved. Terminal flagellar  
segments ventrally excavate. Mandibles red-brown  
24. luperus Shuckard
- Metatarsi 1 and 2 curved or dilated apically.  
Flagellar segments with yellow spots ventrally.  
Mandibles yellow ..... 4
- 4(3) Metatarsus 2 strongly dilated distally (Fig. 146).  
Metatarsus 1 very strongly curved (Fig. 147).  
Midmost antennal segments distinctly longer than  
broad ..... 22. minutus (Fabricius)
- Metatarsus 2 very weakly dilated distally.  
Metatarsus 1 almost straight. Midmost antennal  
segments as long as broad ..... 23. insidiosus Spooner

22. DIODONTUS MINUTUS (Fabricius, 1793)

Figs. 142, 143, 146, 147.

Crabro minutus Fabricius, 1793: 302.

Female: 5-6 mm. Head (Figs. 142, 143), scutum, scutellum and metanotum dull owing to the strong microsculpture, punctuation fine, but rather dense. Mandibles yellow with red apex and brown base. Between antennal sockets a small acute spine. Pad along inner orbits appears more shining than remaining part of frons, due to the missing punctuation, and almost lacking microsculpture. Clypeus as Fig. 142. Antennae black. Humeral tubercle usually yellow spotted. Mesopleuron above coarsely reticulate-rugose, ventrally with fine rugae or striae, like the remaining part of the animal with very sparse, short pubescence. Propodeum shining, with strong irregular ribs. Abdomen shining black. Pygidial area rather coarsely punctate, with distinct microsculpture. Femora black, tibiae red yellow.

Male: 3-4 mm. Lower part of face with dense silvery pubescence. Teeth, delimiting the deep emargination in anterior border of clypeus, truncate apically. Mandibles yellow. Terminal flagellar segments white-yellow ventrally, with very weak emarginations, middle segments distinctly longer than broad. Frons, scutum, scutellum and metanotum with strong microsculpture and scattered, rather fine punctuation. Humeral tubercle yellow. Mesopleuron

above strongly and irregularly rugose, below punctate, with very distinct interstitial microsculpture. Femora black. Tibia 1 and tibia 2 yellow, tibia 3 brown with yellow base. Metatarsi 1 and 2 S-curved, metatarsus 2 dilated apically (Figs. 146, 147).

Common throughout Denmark. - Sweden: along the southern coasts of Sk. and on Öland and Gotland. - Not found in Norway. - Finland: distributed from Ab and N in the south to Kb, Sb and Tb in the north. - Soviet Karelia: Ib and Kr. - Recorded from Europe and large parts of Asia, eastwards to Mongolia.

The nests are found in small sandy walls and slopes. Usually several individuals breed in the same locality, often together with tristis. The prey consists of winged aphids, e.g. Thelaxes suberi Del Guericio (Thelaxidae), each cell being provisioned with about 30 specimens. The nests consist of a main tunnel about 10 cm long, ending in a cell. Along the main tunnel several side tunnels are excavated, which may themselves also branch. Altogether 10-15 cells may be constructed. Recorded parasitoids are Chrysis (Monochrysis) leachii Shuck. (Chrysididae) and Myrmosa melanocephala Fabr. (Mutillidae).

23. DIODONTUS INSIDIOSUS Spooner, 1938

Figs. 144, 145.

Diodontus insidiosus Spooner, 1938: 251.

Female: 4-5 mm. Head (Figs. 144, 145) shining with indications of microsculpture. Punctuation anteriorly very scattered, but somewhat more deep than in minutus. Teeth of clypeus much more close together than in minutus, distance between the lateral teeth distinctly less than shortest distance between these and the lower margin of the eyes. Mandibles yellow with dark apex and base. Spine between antennal sockets vestigial. Antennae black. Pad along inner orbits as in minutus. Ocelli forming a distinctly obtuse angle (Fig. 145). Scutum shining, with scattered, faint punctuation. Striation on mesopleuron and lateral faces of propodeum less pronounced. Microsculpture on pygidial area very weak. All femora, tibia 3 and tarsi black. Tibia 1 with pale front and brown back side. Tibia 2 with brown centre and pale base and apex.

Male: 3-4 mm. Punctuation and pubescence of head as in minutus, but the punctures on upper part of frons usually stronger and more clearly distinguishable from the surrounding, rather weak microsculpture. Antennae short and strong. Flagellar segments about as long as broad, ventrally with yellow-grey spots. Mesopleuron distinctly punctate and rather irregularly micro-

sculptured ventrally. Humeral tubercle and mandibles yellow. Metatarsus 2 only very slightly dilated distally. Tibiae 1 and 2 yellow with faintly brown stroke on the inner side. Tibia 3 brown with a basal yellow or brownish ring.

A single female specimen from Finland: Om in coll. Valkeila. - Scattered in North and Central Europe. Originally described from material from the south coast of England.

Note. Insidiosus has a considerable similarity to the Mediterranean form, friesei Kohl, which may be considered a subspecies. Females of friesei generally has a more densely punctate face (although not nearly so densely as minutus) and scutum, and the microsculpture on the mentioned parts is somewhat stronger than in insidiosus. The pad along the orbits is often more strongly projecting, especially posteriorly. The tibiae are usually of uniform colour, as in minutus. Males are distinguishable by the absence of pale ventral spots on flagellar segments, and by metatarsus 2 being very slightly dilated distally.

24. DIODONTUS LUPERUS Shuckard, 1837

Diodontus luperus Shuckard, 1837: 186.

Female: 5-6 mm. Head with strong reticulate microsculpture and sparse, deep punctation. Clypeus shining, with only a few bristle-bearing punctures on posterior half. Without spine between antennal sockets. Mandibles black with slightly paler apex. Scutum with somewhat effaced microsculpture and scattered punctation, which becomes very weak in posterior half of the sclerite. Humeral tubercle black. Mesopleuron above with rather coarse, irregular rugae, ventrally indistinctly striate. Propodeum with strong ribs. Pygidial area as in minutus, with strong microsculpture mixed with punctures. Legs black with pale knees and tarsi. Tibia 1 with a pale streak along anterior edge.

Male: 4-5 mm. Head very densely and rather coarsely punctate with strong microsculpture. Lower part of face with dense silvery pubescence. Mandibles black or black-brown. Antennae long and slender, black. Terminal flagellar segments with slightly oblique ventral excavations. Punctuation of scutum, especially on anterior half, forming longitudinal rows, microsculpture comparatively weak. Mesopleuron in front of coxa 2 distinctly punctate, with somewhat irregular, transverse microsculpture. Propodeum coarsely rugose. Legs black with yellow knees. Tibia 1 with yellow front side.

The species is rather common in Central Europe, and is found in England

as well as in northern Germany. It is distributed over large parts of Asia, eastwards to Kazakhstan and Mongolia.

The prey consists of Aphididae, e.g. Myzus and Macrosiphum. A single cell may contain 22 individuals.

Note. The species recorded by Pulkkinen (1931) from Finland: Ab, Uskela, is a male of medius Dahlbom (Hellén, 1954). Thus the species is not found in the north, but might possibly appear in southern Denmark.

25. DIODONTUS TRISTIS (van der Linden, 1829)

Fig. 141.

Pemphredon tristis van der Linden, 1829: 76.

Female: 6-8 mm. Head strongly and densely punctate. Punctures partly coalescing into small longitudinal rugulae. Microsculpture weak, consisting only of short longitudinal raised lines. Clypeus shining, median tooth strong. Mandibles black. Furrow along inner orbits half as broad as flagellum. Scutum shining, with only indications of microsculpture in anterior part. Punctures indistinctly delimited posteriorly. Scutellum almost smooth, with only few punctures along posterior margin of the coarsely pitted, depressed, anterior border. Humeral tubercle black. Mesopleuron in front of coxae 2 smooth and shining, laterally coarsely reticulate-rugose and striate. Propodeum dorsally with coarse, reticulate rugae. Abdomen with short, thin, adpressed pubescence. Pygidial area distinctly microsculptured, posteriorly with coarse punctures. Legs black.

Male: 5-7 mm. Frons shining with coarse, partly coalescing punctation. Genae very strongly striate, with long greyish pilosity. Occipital carina strongly raised. Antennae black, 7th to 10th flagellar segments with dull, oval tyloidea. Humeral tubercle yellow posteriorly. Scutum anteriorly very densely and rather coarsely punctate, posteriorly punctation becomes coarser and sparser. Scutellum shining, with few, evenly distributed punctures. Mesopleuron and propodeum sculptured as in female. Abdomen shining, almost naked, weakly constricted between first and second tergum. Femora black. Tibia 1 and tibia 2 brown with partly yellow inner side. Tibia 3 brown with yellow base and apex.

Common in most districts in Denmark, and fairly abundant in southern Sweden. Northern occurrence in Sweden in Upl. and Gstr. - Norway: a little material from AK and Ø. - Finland: very rare, a few specimens from Ka, Ta and Sa. - Common throughout Europe, in Asia recorded from Kazakhstan and Mongolia.

The nests are constructed in dry sandy soil, often in small slopes or walls. Not uncommonly found breeding in gravel pits and the like. The tunnel system may be very complicated, since main as well as side tunnels are often considerably branched. Number of cells varies from 2 to more than 20. Wingless aphids (Aphididae) are used as prey, e.g. Hyalopterus pruni Geoffr. The prey is paralyzed (killed) by powerful bites in the thoracic region. As far as known, the sting is not used. 20-40 aphids constitute the provision for each larva. The fully grown larva spins a firm cocoon, the outside of which is covered with attached sand grains. In Denmark the species occurs in two generations, of which the latter, in August-September, seems to be the richer in individuals (Nielsen, 1933). As parasitoids are recorded Myrmosa melanocephala Fabr. (Mutillidae) and Hammomyia albescens Zett. (Anthomyiidae). Concerning the latter, the statement must be regarded as misleading, since the family is exclusively herbivorous. On the other hand, it is probable that flies within the family Miltogrammatidae may be found parasitic on the species of Diodontus.

26. DIODONTUS MEDIUS Dahlbom, 1845

Fig. 18.

Diodontus medius Dahlbom, 1845: 249.

Diodontus dahlbomi A. Morawitz, 1864: 461.

Female: 7-8 mm. Frons very densely and finely punctate, interspaces anteriorly smaller than diameter of punctures, with very fine microsculpture. Between antennal sockets a small convexity. Clypeus shining in the middle, laterally densely and finely punctate, with thin, greyish pubescence. Median tooth truncate, considerably shorter than lateral teeth. Mandibles black with slightly pale apex. Furrow along inner orbits almost as broad as flagellum. Scutum more finely and densely punctate than in tristis. Humeral tubercle black or brownish. Mesopleuron in front of coxa 2 dull with distinct microsculpture and fine, scattered punctation. Lateral face of mesopleuron strongly striate, irregularly rugose dorsally. Abdomen black, with thin pubescence. Legs black, tibiae and tarsi lighter or darker brown.

Male: 5-7 mm. Frons dull, densely and finely longitudinally rugose, without distinct microsculpture in anterior part, punctation here finer and denser. Genae densely striate, with short hairs. Antennae black, 9th to 11th flagellar segment each with a very weak excavation. Scutum anteriorly with two pairs of short longitudinal carinae. Punctation of thorax as in female, but slightly stronger. No secondary sexual characters have been found in the morphology of the tarsi.

Denmark: EJ, Lisbjerg Skov, 1 ♀, 10.VII. 1964 (B. Overgaard). - Rather common in Sweden and Finland, especially in the central parts. Northernmost occurrence in Sweden in Jmt. and Ång., in Finland in ObS and Ks. - Norway: a few specimens from Ak, HEs and Bv. - A few records from northern Germany and the northern parts of European U. S. S. R.

Nests in sandy soil. A single nest was described by Adlerz, 1903: main tunnel about 10 cm long, ending with a cell. Four short side tunnels also ended with a cell each. Provision consists of large aphids, of which 7-9 are placed in each cell. Egg deposited on ventral side of prey.

## Genus *Passaloecus* Shuckard

Passaloecus Shuckard, 1837: 188.

Type-species: Pempredon insignis van der Linden, 1829.

Comparatively small, slender, black species (Fig. 148). In nature they have a superficial resemblance to the smaller species of Crossocerus. Head short, flat anteriorly. Mandibles of female highly specialized: somewhat widened distally, on the inner side with an excavation, surrounded by a row of strong, erect bristles. Mandibles of male more simple. Clypeus of female with rather strongly projecting, usually straight or slightly emarginate central lobe; its pubescence usually sparse. In males the central lobe is less well developed, and the silvery pubescence very dense. Antennae of male usually with secondary sexual characters in form of tyloidea or assymmetrical segment. Mesopleuron with a, sometimes double, vertical, coarsely pitted furrow and one or two horizontal, also strongly pitted furrows. Propodeum long, reticulate. Abdomen with very short petiolus. Female without pygidial area. Apex of male abdomen with upward bent, sting-like appendage. Legs thin, foretarsi of female without tarsal pecten. Forewings with two cubital cells, the first more than twice as long as the second. The two discoidal transverse veins each join one cubital cell.

A cosmopolitan genus containing a great number of species; about 15 species occur in Europe.

The species nest in dry, usually pith-filled stems, abandoned insect tunnels in wood or in various galls (Fig. 11). For taxonomy of gracilis, turionum and borealis, see Yarrow, 1970.

Key to species of Passaloecus

- 1 Mesopleuron laterally with two horizontal, deeply pitted furrows (Figs. 148, 159). Area between these distinctly punctate, of shiny appearance, microsculpture reduced or absent ..... 2
- Mesopleuron laterally with only one horizontal, deeply pitted, furrow. Area dorsal to this dull, very finely punctate, with distinct microsculpture ..... 7
- 2(1) The vertical, deeply pitted furrow on mesopleuron is double (Fig. 149). Anterior border of clypeus with squarely truncate or slightly emarginate, anterior border. Male antennae with tyloidea ..... 3
- The vertical, deeply pitted furrow on mesopleuron is single (Fig. 150). Female: anterior border of clypeus with three teeth. Male: antennae with or without very few and indistinct tyloidea ..... 6
- 3(2) Female: labrum very short, sides convex (Fig. 154) Anterior border of clypeus arcuately emarginate. Male: tyloidea distally sharply truncate, only slightly longer than half length of segments (Fig. 162) 30. brevilabris Wolf
- Female: labrum longer, sides concave subapically. Clypeus with straight or slightly concave anterior border. Male: tyloidea distinctly longer than half length of segments, evenly rounded distally ..... 4
- 4(3) Scutum strongly sculptured; anterior corners, posterior border and the two deeply pitted parapsidal furrows are distinctly striate. Female: central lobe of clypeus narrower than labrum, its lateral corners rounded (Fig. 152). Inner orbits distinctly converging ventrally. Male: tyloidea strongly projecting, in profile as Fig. 160 ..... 27. gracilis (Curtis)
- Anterior corners and posterior border of scutum with or without weak striae. Parapsidal furrows weak, transverse carinae of these strongly reduced or completely missing. Female: central lobe of clypeus as broad as, or slightly narrower, than labrum. Inner orbits not or weakly converging

ventrally. Male: tyloidea slightly projecting, in profile as Fig. 161 .....

5

- 5(4) Smaller (3.5-5.5 mm). Female: head in front view as Fig. 151. Anterior border of clypeus narrower than width of labrum. Male: antennae comparatively short, tyloidea on 8th-11th antennal segments distinctly shorter than length of segments (Fig. 161) ..... 28. turionum Dahlbom
- Larger (4.3 - 6.0 mm). Female: head in front view as Fig. 153. Anterior border of clypeus as broad as labrum. Male: antennae relatively longer, tyloidea on 8th-11th antennal segments as long as length of segments ..... 29. borealis Dahlbom
- 6(2) Frons between antennal sockets with very small spine. Female: clypeus shiny, plane, with sparse silvery pubescence (Fig. 156). Third antennal segment almost twice as long as broad. Male:

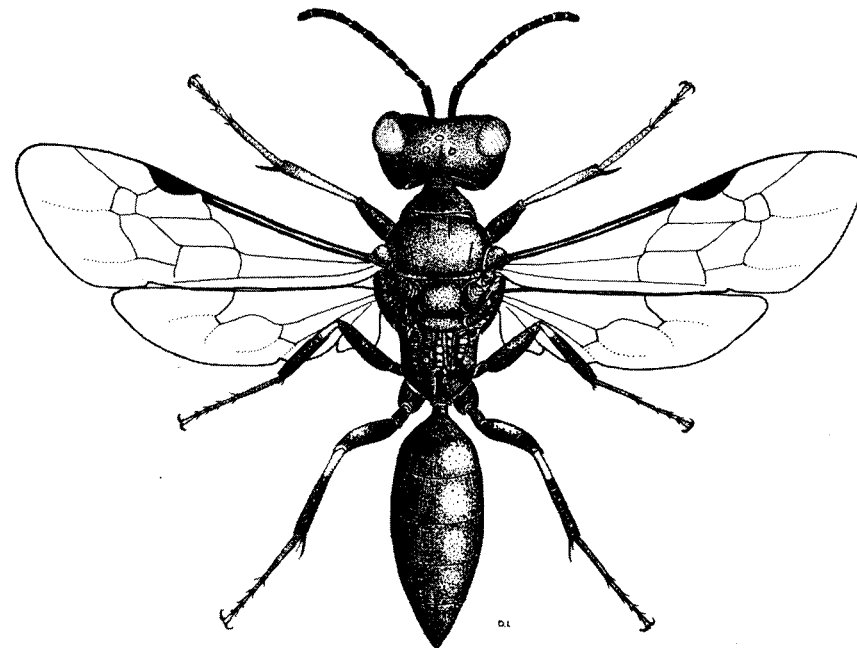

Fig. 148. Female of Passaloecus insignis (v. d. Lind). Length: 5-6 mm.

- antennae relatively long, segments simple, pale ventrally ..... 31. eremita Kohl
- Frons between antennal sockets with strong, compressed spine. Female: clypeus dull, strongly convex, with dense silvery pubescence (Fig. 155). Third antennal segment only slightly longer than broad. Male: antennae comparatively short, 8th-12th antennal segments ventrally drawn out into a forwardly directed distal tooth (Fig. 165), dark ventrally ..... 32. corniger Shuckard
- 7(1) Abdomen with distinct constriction between first and second tergum. Dorsal face of propodeum longer than posterior face. Male antennae slender, tyloidea very indistinct. Relatively small and very slender species ..... 8
- Abdomen without constriction between first and second tergum. Dorsal face of propodeum as long as posterior face. Tyloidea on more or less moniliform antennae of males, strongly developed. Medium-sized, rather robust species ..... 9
- 8(7) Clypeus strongly projecting, rounded anteriorly (Fig. 158). Humeral tubercle with large whitish spot. Labrum short with slightly concave sides ..... 36. clypealis Fæster
- Clypeus normally projecting, anterior border in female squarely truncate (Fig. 157), in male slightly concave. Sides of labrum distinctly concave (Fig. 157). Humeral tubercle black, sometimes very slightly paler in females. 35. singularis Dahlbom
- 9(7) Female: labrum, maxillary and labial palps whitish yellow (Fig. 159). Narrow depressed area along margin of lateral ocelli very indistinctly delimited. Upper part of frons with relatively weak microsculpture. Male: antennal segments in profile comparatively slightly dilated, tyloidea relatively short (Fig. 163) ..... 33. insignis v.d. Linden
- Female: labrum, maxillary and labial palps lighter or darker brown. Narrow depressed area along

lateral ocelli laterally sharply delimited. Upper part of frons with relatively strong microsculpture. Male: antennal segments in profile strongly dilated, tyloidea usually as long as segments (Fig. 164)

34. monilicornis Dahlbom

27. PASSALOECUS GRACILIS (Curtis, 1834)

Figs. 152, 160.

Diodontus gracilis Curtis, 1834: 496.

Female: 4.5-5.5 mm. Head (Fig. 152) distinctly narrowing downwards towards mandibular articulation. Frons in front of ocelli dull, with distinct, comparatively strong punctation, interspaces equal to or less than diameter of punctures. Microsculpture relatively weak. Median lobe of clypeus distinctly narrower than labrum, usually narrowly depressed along anterior border, its corners rounded. Labrum usually with strongly concave sides subapically. Mandibles with large ivory coloured spot. Antennae short, median segments of flagellum only slightly longer than broad. Scapus usually with large ivory coloured spot along frontal side. Ivory coloured spot on humeral tubercle may be reduced or absent. Scutum comparatively strongly sculptured, punctation dense. Parapsidal furrows well-developed, with strong transverse striation. Especially laterally, but also basally on scutum, are short but strong carinae. Mesopleuron with double vertical and two horizontal, deeply pitted furrows; area between two last mentioned smooth and shiny, with or without extremely weak microsculpture. Punctation distinct.

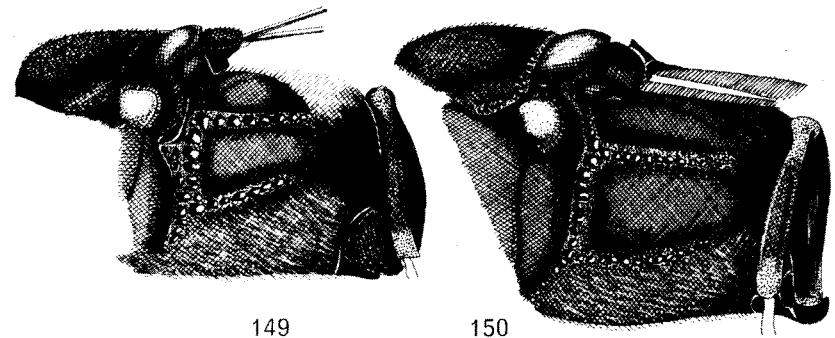

Figs. 149-150. Mesopleuron in female Passaloecus. - 149: turionum Dahlbom; 150: eremita Kohl.

Male: 3.5-5.0 mm. Inner orbits very distinctly converging ventrally. Punctuation of frons very dense, punctures sometimes coalescing transversely, whereby microsculpture is reduced. Antennae ventrally with well developed tyloidea, seen in profile distinctly convex (Fig. 160). Scutum with stronger sculpture than in female. The deeply pitted, transversely striate, parapsidal furrows often reach almost to posterior border of scutum. Mandibles, scapus and humeral tubercles often without white marks. Furrows on mesopleuron very well-developed.

The species is common and distributed over large areas in Denmark and southern Sweden, northwards to Boh., Vstm. and Upl. - Norway: a few specimens from AK, HOi and SFi. - Finland: an extreme southern distribution: Al, Ab and Ta. - A Holarctic species, but probably introduced to North America (listed as turionum Dahlbom by Krombein and Burks, 1967; corrected by Vincent, 1973, in litt.).

The nests may be found in dry plant stems, e.g. Phragmites and Sambucus, and in abandoned insect tunnels in old timber, also in agamic galls of Andricus kollari Htg. (Hym., Cynipidae) on Quercus spp. Larva described by Janvier, 1961. Prey consists of Lachnidae and Aphididae. Eurytoma nodularis Boh. (Hym., Chalcidoidea), Chrysis cyanea L. and Omalus aeneus (Hym., Chrysididae) are recorded as predators.

28. PASSALOECCUS TURIONUM Dahlbom, 1845

Figs. 149, 151, 161.

Passaloecus turionum Dahlbom, 1845: 246.

Passaloecus brevicornis A. Morawitz, 1864: 462.

Female: 4.5-5.5 mm. Closely related to the preceding species. Head (Fig. 151) comparatively broader. Frons in front of ocelli shiny, punctuation comparatively weak. Interstices equal to or greater than diameter of punctures. Microsculpture distinct. Middle lobe of clypeus usually narrower than labrum, anterior border distinctly arcuately emarginate, lateral angles sharp. Sides of labrum slightly concave subapically. Antennae longer than in gracilis. Scutum weakly sculptured, striation laterally, in the weak parapsidal furrows and basally, very reduced. Mesopleuron between the two horizontal furrows weakly and rather shallowly punctate.

Male: 4-5 mm. Punctuation on frons weak, never fusing. Antennal segments longer than in gracilis, with flatter tyloidea (Fig. 161). Ivory coloured marks on mandibles, scapus and humeral tubercles only seldom reduced. Parapsidal furrows extend beyond central part of scutum, even in robust individuals.

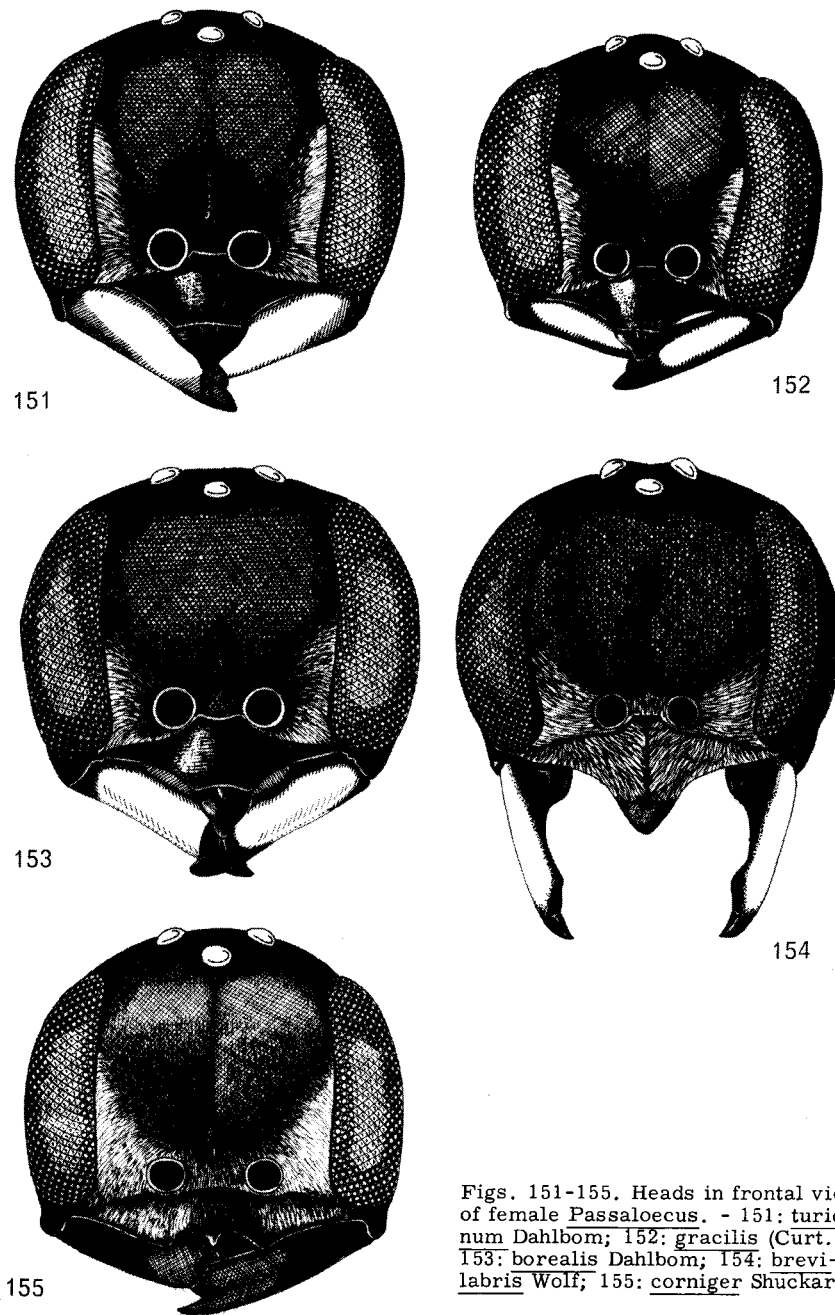

Figs. 151-155. Heads in frontal view of female Passaloecus. - 151: turionum Dahlbom; 152: gracilis (Curt.); 153: borealis Dahlbom; 154: brevilabris Wolf; 155: corniger Shuckard.



Denmark: very sparsely distributed, predominantly in coniferous plantations in WJ, F, and NEZ. - Sweden: widely distributed from Sk. in the south to Dlr. and Ång. in the north. - Norway: a few records from AK, On and HOi. - Finland: common throughout the country. - Probably a boreo-alpine species in Europe.

The species has been found breeding in resin-galls of Petrova resinella L. (Lep., Tortricidae) on e.g. Pinus contorta and P. silvestris. As a nesting place the species probably also uses abandoned insect tunnels. Omalus biacinctus (Buys.) and O. aeneus F. (Hym., Chrysididae) are found as predators.

29. PASSALOEUCUS BOREALIS Dahlbom, 1845

Fig. 153.

Passaloecus borealis Dahlbom, 1845:247.

Female 5.5 - 6.5 mm, male: 5.6 mm. Recognizable by its considerable size. Head (Fig. 153) comparatively broader and antennae of males considerably longer than in turionum. Striation at base of scutum extremely weak or absent. Specimens from the Alps and the Pyrenees often lack the yellow proximal ring on tibia 3.

The distribution within Fennoscandia is very poorly known, since turionum auctt., nec Dahlbom (Merisuo, 1972) has been included in this species. - Denmark: a few specimens from NEZ. - Sweden: very local, known from Sm., G. Sand. (?), Jmt. and Ly. Lpm. - Norway: Nsy, Verdalen (Dahlbom). - Finland: Al, Ab, Ta, Sb, N (Merisuo, 1973, in litt.) - Boreo-alpine distribution in Europe. The species also occurs in the Rocky Mountains in the U.S.A. (Vincent, 1973, in litt.), and in south-eastern Kazakhstan (Kazenas, in litt.).

30. PASSALOEUCUS BREVILABRIS Wolf, 1958

Figs. 154, 162.

Passaloecus brevilabris Wolf, 1958: 15; Beaumont, 1963: 298.

Closely related to turionum. Female: 4.5-6 mm. Clypeus (Fig. 154) with dense and strongly developed silvery pubescence. Anterior border distinctly arcuately emarginate. Labrum very short, sides convex.

Male: 4-5 mm. Mandibles and scapus with very extensive yellow markings. Tyloidea very short, never longer than half the length of the antennal segments, and distally sharply truncate (Fig. 162).

Distribution in Fennoscandia limited to Central Sweden: Sm., Öl., Gtl., Ög., Sdm. and Gstr., and southern Finland: Al, Ab. - A boreo-alpine species in Europe.

31. PASSALOEUCUS EREMITA Kohl, 1893

Figs. 11, 150, 156.

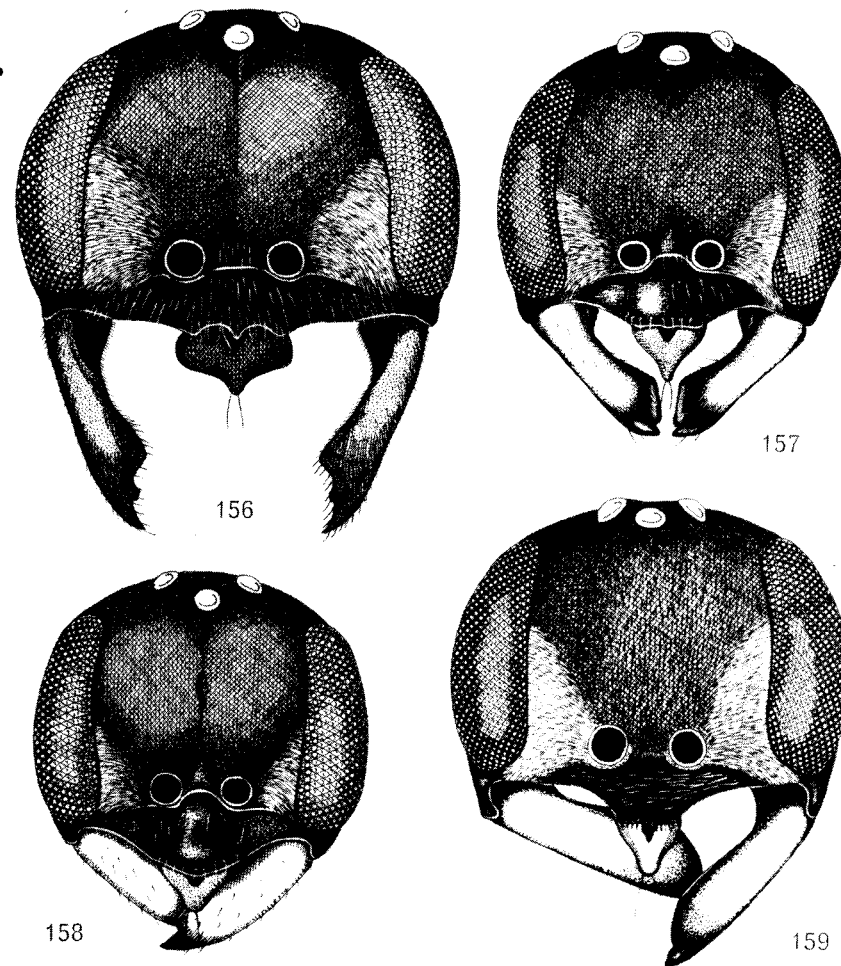

Figs. 156-159. Heads in frontal view of female Passaloecus. - 156: eremita Kohl; 157: singularis Dahlbom; 158: clypealis Fæster; 159: insignis (v.d.Lind.).

Passaloecus eremita Kohl, 1893: 37.

Female: 5-6.5 mm. Head (Fig. 156) in front view very broad. Clypeus rather shiny, weakly convex, its anterior border with three rather weak teeth. Pubescence sparse, slightly silvery. Labrum short, very broad, distally abruptly narrowed, forming a truncate process. Frons between antennal sockets with or without a tiny spine. Colour of mandibles much varying, often with yellow longitudinal stripe. Cutting edge broad, in middle with broad angular projection. Antennae long and slender, all segments distinctly longer than broad, third segment about 1.5 times longer than broad. Scutum densely and finely punctate, parapsidal furrows indistinct. Mesopleuron with a single vertical and two horizontal deeply pitted furrows. Humeral tubercle sometimes with white-yellow spot. Tibia 3 with proximal white-yellow ring.

Male: 3.5-6 mm. Anterior border of clypeus with three very weakly indicated teeth, often concealed by the dense and well developed pubescence. Labrum, palpi, mandibles, scapus and humeral tubercles extensively yellow. Antennae long and slender, segments about 1.5 times longer than broad, yellow-brown ventrally. 11th and 12th segments with quite small shiny tyloidea. Sculpture of thorax as in female. Sixth tergum near posterior border with two small tubercular thickenings with long setae. Tibia 3 with white-yellow proximal ring.

The species occurs rather sporadically but may occur in large numbers locally. - Denmark: only recorded from NEZ. - Sweden: from Sm. in the south to Gstr. and Jmt. in the north. - Norway: 2 specimens from AK, Bygdø. - Finland: widely distributed, from Al, Ab and N to Om and Ks. - Soviet Karelia: Ib. - Distributed all over Europe, but rare.

The species has been found breeding in very large numbers in roofs thatched with Phragmites in Denmark: NEZ. In one locality 173 nests were found in five meters of eaves. The number of cells varies with the length of the straws: on average 4-5 cells are constructed. A row of cells always terminates with an empty vestibular cell of varying length (parasite protection?). The partitions between the cells are made of conifer resin, which gradually hardens and acquires a whitish or pale yellow colour. The inhabited straws are easily recognizable by being sealed with a plug of resin. Usually a ring of small drops of resin is placed round the entrance, probably to prevent intrusion of cleptoparasites (Fig. 11). Very often earlier inhabited straws are used, even if these had housed species of e.g. insignis, singularis, corniger or e.g. Trypoxylon figulus, or Rhopalum coarctatum. The last constructed cells usually contain males, which are the first to emerge. The sex ratio

(females/males) lies round 1.4. In straws so thin that the animal cannot turn, the adult larva is orientated with its head facing the entrance (see Lomholdt, 1973). Prey consists of Homoptera, Lachnidae, e.g. Cinara pinea (Mordv.), which lives on Pinus. The nest may also be constructed in decayed wood, often in connection with abandoned insect tunnels. In wood the tunnel system may be branched. All nests are of linear type. The larva was described by Janvier, 1961.

As cleptoparasites are recorded Omalus aeneus Fabr., Chrysis cyanea L. (Hymenoptera, Chrysididae), Perithous mediator Fabr. (Hymenoptera, Ichneumonidae) and Megatoma undata L. (Coleoptera, Dermestidae). The larva of the latter usually destroys 2-4 cells.

32. PASSALOEUCUS CORNIGER Shuckard, 1837

Figs. 155, 165.

Passaloecus corniger Shuckard, 1837: 191.

Female: 5-6.5 mm. Head in front view (Fig. 155) comparatively long, inner orbits almost parallel. Clypeus strongly convex, with three strong teeth on anterior border, pubescence dense and strong, silvery. Labrum short and broad, with convex sides. Mandibles either uniformly dark or with small, whitish basal spot. Their cutting edge distinctly tridentate. Frons between

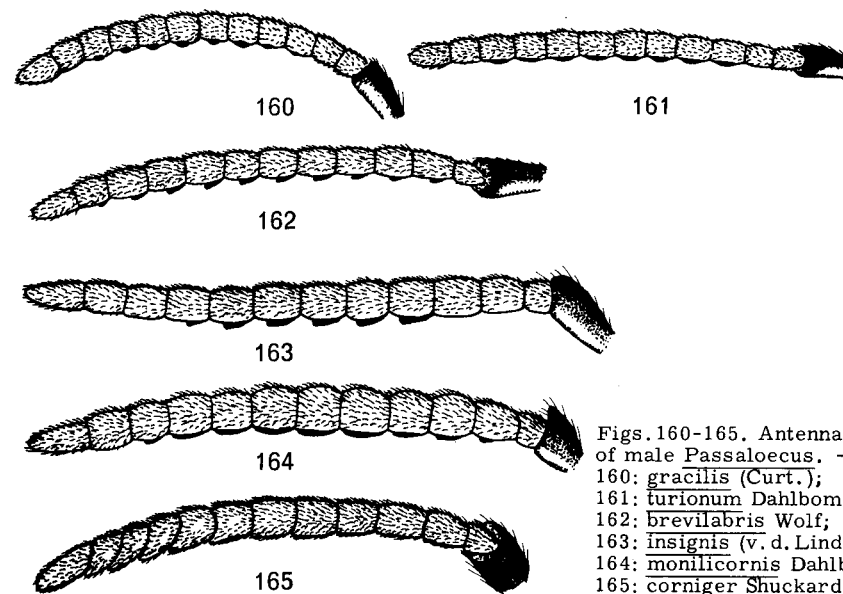

Figs. 160-165. Antennae of male Passaloecus. - 160: gracilis (Curt.); 161: turionum Dahlbom; 162: brevilabris Wolf; 163: insignis (v. d. Lind.); 164: monilicornis Dahlbom; 165: corniger Shuckard.

antennal sockets with strong, compressed spine. Eyes often with distinct setae. Antennae short and thick, segment in profile very slightly longer than broad. Yellow spot on scapus usually very reduced. Humeral tubercle with large whitish spot. Thorax sculptured as in eremita. Tibia 1 uniform red-brown, tibia 3 with red-brown proximal ring.

Male: 4.5-6 mm. Frons between antennal sockets with a strong, compressed spine. Labrum, palpi, mandibles and anterior face of scapus and usually also humeral tubercles yellow. Anterior border of clypeus with three small, rounded teeth. 8th-12th antennal segments drawn out into a ventral tooth (Fig. 165), ventral face dark. 6th tergum near posterior border with two very weak hairy thickenings. Legs with extensive red-brown markings.

The species is common in Denmark and Fennoscandia. Northern distribution limit in Sweden runs through Dlr. and Hls., in Norway through HOy and HEn. - A southern species in Finland. - Widely distributed in the Palaearctic region, through Asia to Japan.

As regards breeding biology, it closely resembles eremita, with which it often occurs. In addition, stated to breed in galls of Lipara (Diptera, Chloropidae) on Phragmites. Occasionally found breeding in old timber, including beams, in human habitations. Prey: Homoptera Aphididae, e.g. Aphis and Anuraphis. Larva described by Janvier, 1961. Parasites: Eurytoma nodularis Boh. (Hym., Chalcididae) and Chrysis cyanea L. (Hym., Chrysididae).

Note. The thorough observations by Corbet (1975) confirm the suggestion made by Chevalier (1923) that corniger does not catch aphids, it rather robs provision from other Passaloecus-nests, even from conspecific nests. The evolution of conspecific robbery is difficult to explain in terms of positive selection, but such a behaviour is likely to be present only in crowded populations.

33. PASSALOECUS INSIGNIS (van der Linden, 1829)

Figs. 148, 159, 163.

Pemphredon insignis van der Linden, 1829: 79.

Passaloecus monilicornis Dahlbom, 1842: (p.p.).

Passaloecus roettgeni Verhoeff, 1890:383.

Female: 5-6 mm. Head (Fig. 159) in front view broad, inner orbits slightly converging ventrally. Lower part of face with rather sparse, but very distinct silvery pubescence. Hairs of clypeus with tips directed towards mid-

line. Anterior border of clypeus straight or weakly arcuately emarginate. Mandibles, labrum, palpi and scapus extensively white-yellow or ivory coloured. Marking on labrum V-shaped. Mandibles almost straight, only slightly and gradually dilated apically. The small cavity near lateral ocelli indistinctly delimited. Humeral tubercle with large white-yellow spot. Mesopleuron with a single vertical and only one horizontal, deeply pitted furrow; surface dull due to well developed microsculpture. Punctuation very fine. Reticulation of propodeum rather coarse on shiny smooth ground.

Male: 4.5-5.5 mm. Mandibles short, slightly curved, their white-yellow markings may be greatly reduced. Median lobe of clypeus strongly convex, silvery pubescence well developed. Anterior face of scapus with larger or smaller white-yellow spot. 5th to 10th antennal segments slightly dilated, ventrally with strongly projecting, distally sharply truncate tyloidea (Fig. 163). Humeral tubercle often without pale mark. Thorax sculptured as in female. 6th tergum near posterior border with two backwardly directed, short spines, situated on small tubercular elevations.

Common in Denmark and in southern Sweden: from Sk. to Dls. and Upl. - A few specimens from southern Norway: AK. - Finland: not common, occurs sparsely in the south-western districts. - Distributed over large areas in Europe, eastwards through Asia to Japan.

The nests are found, often in large numbers, in old thatched roofs as described in eremita. Pith-filled stems of e.g. Sambucus or abandoned insect tunnels in decayed wood, often old beams in buildings, are also used as a breeding biotope. Sometimes, where the nests are constructed in long stems, the number of cells may be as many as 15-18. Each cell is sealed with a disc of resin. As prey are used Homoptera, Aphididae and Lachnidae, e.g. Anuraphis and Cinara. Nests of insignis are common in abandoned or commenced nests of other species of Passaloecus, Pemphredon inornatus Say (no. 18) and P. lethifer Shuckard (no. 19); Trypoxylon figulus (no. 106) and Rhopalum coarctatum Scop. (no. 140). Larva described by Janvier, 1961.

34. PASSALOECUS MONILICORNIS Dahlbom, 1842

Fig. 164.

Passaloecus monilicornis Dahlbom, 1842: 12.

Closely related to insignis, from which it can only be separated by the characters mentioned in the key.

The species is not yet recorded from Denmark, but occurs in all Fennoscandia.

scandinavian countries. In Sweden it is rather common, being distributed from Sk. to Nb. - Norway: rather common in the southern districts, also a single specimen from Nnø. - Finland: common and widely distributed, northernmost record from Li, north of Lake Inari (about 69°N!). - A northern boreal species in Europe, which is not recorded, either from the Alps or the Pyrenees. The distribution extends eastwards to Mongolia, China, Japan, Korea and Kamchatka.

Breeding biotope in abandoned insect tunnels in dead wood. The tunnels are cleaned of wood dust and the like, and may be elaborated. The species is able to gnaw new tunnels in not too hard wood. The nest tunnels are often branched; the cells are, however, placed in rows. Number of cells may be as high as 22 (Tsuneki, 1955).

Note. The distribution pattern of *P. insignis* and of *P. monilicornis* in Fennoscandia emphasizes the view that the two taxa should be maintained at specific level (cf. Yarrow, 1970: 184).

35. PASSALOEUCUS SINGULARIS Dahlbom, 1844  
Fig. 157.

Passaloecus singularis Dahlbom, 1844: 243.

Passaloecus tenuis A. Morawitz, 1864: 462.

Passaloecus gracilis auctt.

Female: 4.5-5.5 mm. Head in front view (Fig. 157) longer and narrower than in *insignis*. Clypeus rather shiny with weak, reticulate microsculpture, especially laterally. Anterior border itself slightly depressed, marked by a row of bristle-bearing punctures. Silvery pubescence very sparse and weak, hair tips directed ventrally. Labrum black or brown-black, distinctly constricted subapically. Mandibles slightly curved, black with brownish apex, with larger or smaller whitish spot in the middle. Anterior face of scapus with white-yellow spot. Humeral tubercle with or without light mark. Mesopleuron with a vertical and a single horizontal, deeply pitted furrow. Abdomen with distinct constriction between first and second segment.

Male: 3.5-4.5 mm. Very slenderly built. White-yellow pattern on mandibles and scapus very variable in extent, sometimes completely missing. Antennae long and slender, 5th to 10th segments ventrally with flat, broad, brownish tyloidea. Humeral tubercle usually black. Thorax and abdomen as in female, only a little more strongly sculptured. 6th tergum without spines or tubercles.

A common species in Denmark and Fennoscandia. - Sweden: from Sk. to Dlr. and Med. - Norway: a few specimens from AK. - Finland: widely distributed from Al, Ab, and N to Ok and ObS. - Soviet Karelia: Ib and Kr. - Known throughout Europe and distributed through Asia to Japan.

Nests usually in pith-filled stems, e. g. of *Rubus*, *Ribes*, *Rhamnus*, *Sambucus* and in *Phragmites*, or in empty galls of *Lipara* (Dipt., Chloropidae) in *Phragmites communis*. Nests are often constructed in abandoned insect tunnels in rotten wood, in association with human habitations. The nests of this species are easily recognized by the mixture of resin and small pebbles of 0.5-1 mm diameter used in the final sealing of the entrance. The length of the terminal plug may be up to 1 cm. The prey consists of wingless individuals of Homoptera, Aphididae, e. g. *Aphis*. Cleptoparasites are *Perithous mediator* Fabr., *P. divinator* Rossi (Hym., Ichneumonidae), *Eurytoma* sp. (Hym., Eurytomidae), *Omalus auratus* Fabr. and *Chrysis cyanea* L. (Hym., Chrysididae). Larva described by Janvier, 1961.

36. PASSALOEUCUS CLYPEALIS Fæster, 1947  
Fig. 158.

Passaloecus clypealis Fæster, 1947: 204.

Passaloecus angustus Gussakovski, 1952: 215, syn. n.

An easily recognizable species (see the key), but closely related to *singularis*. Shape of clypeus (Fig. 158), the almost equilaterally triangular labrum, and the slender antennae are good specific characters. Male moreover easily recognizable by the very reduced tyloidea on 8th and 9th antennal segments.

A rare species. - Denmark: only known from WJ, F and SZ (type locality). - Sweden: a few specimens from Ög., Nrk. and Upl. - Not recorded from Norway. - Finland: the species occurs in very large numbers in Ab, Rymätylä (Merisuo, 1973); also known from Al, Ta, Sa, Kb and Om. - Widely distributed throughout central and northern Europe.

Only few observations exist of the nesting of this species (Janvier, 1961; Merisuo, 1973). The nests were found in stems of *Lonicera* and *Phragmites*. The partitions between the cells, and also the terminal plug, consisted of a mixture of resin (?) and small pebbles. It is also probable that empty *Lipara* galls in *Phragmites* may be used as nesting place, since the species has often been found associated with brackish and fresh water. Often occurs together with *Rhopalum nigrinum* (no. 141), *Chrysis cyanea* L. (Chrysididae) is probably parasitoid (Merisuo, in litt.).

Note. Recorded as *P. augustus* sp. n. by Gussakovski from several localities in western Russia, eastwards to Uzbekistan. Additional material from Kazakhstan (Kazenas, in litt.).

## Genus *Stigmus* Panzer

*Stigmus* Panzer, 1804: H. 86, T. 7.

Type-species: *Stigmus pendulus* Panzer, 1804.

Small, slender species (Fig. 166) with or without very limited yellow markings. Head in front view broader than high. Vertex, especially in females, strongly developed. The forwardly directed ommatids are pronouncedly larger than those placed dorsally in the eyes. Clypeus in female shining, anteriorly produced into truncate teeth, which are separated by a U-shaped emargination (Fig. 163). In males clypeus is covered by a silvery shining pubescence; mid-part of anterior border broadly rounded, squarely truncate or rather weakly arcuate-emarginate. Mandibles yellow with red apex, tridentate in females, bidentate in males. Antennae rather short, pale. Pronotum very short with a sharp transverse carina. Humeral tubercle reaching almost to articulation of forewings. The parapsidal furrows coarsely pitted. Mesopleuron in European species laterally with a strong, double vertical and two more or less distinct horizontal furrows crossed by carinae. Propodeum large, with coarse reticulation. Petiolus long; abdomen shining, smooth, with microscopic sculpture. Female with a quite small pygidial area. Tarsi long and slender, pale like tibiae. Metatarsus 2 with a single apical spur. Forewings with two cubital cells and a single discoidal cell. Stigma very large.

Only two species in Europe, genus otherwise with world distribution, only absent from Australia and New Zealand. The species nest in hollow or pith-filled plant stems, abandoned tunnel systems of xylophageous insects or in galls. Prey consists of aphids (Aphididae).

### Key to species of *Stigmus*

- 1 Humeral tubercle with yellow or brown-yellow spot. Area below wing base reticulate. Male: anterior border of clypeus evenly arcuately concave (Fig. 168). Mesopleuron dull, with distinct reticulate microsculpture ..... 37. *solskyi* A. Morawitz
- Humeral tubercle black or brown-black. Area below wing base with only weak rugae. Male: anterior

border of clypeus straight or weakly arcuately emarginate (Fig. 169). Mesopleuron ventrally shining, at most with indicated microsculpture ..... 38. *pendulus* Panzer

37. *STIGMUS SOLSKYI* A. Morawitz, 1864  
Figs. 166-168.

*Stigmus solskyi* A. Morawitz, 1864: 462

*Stigmus europaeus* Tsuneki, 1954: 25.

*Stigmus verhoeffi* Tsuneki, 1954: 27.

Female: 3.5-5 mm. Frons anteriorly with weak longitudinal furrow, very finely and sparsely punctate with interstitial microsculpture. Antennal segments 4 and 5 of equal length. Clypeus shining, sometimes slightly transparent anteriorly; with long, sparse pubescence. Humeral tubercle pale. Scutum and scutellum dull with extensive microsculpture. Mesopleuron laterally, just below wing base, coarsely reticulate-rugose, whereby the dorsal of the two horizontally running furrows often disappears. Area in front of coxa 2 rather shining, with distinct, reticulate microsculpture.

Male: 3-4.5 mm. Head in front view very broad, eyes very strongly convex. Clypeus with broadly projecting median part, on either side delimited by

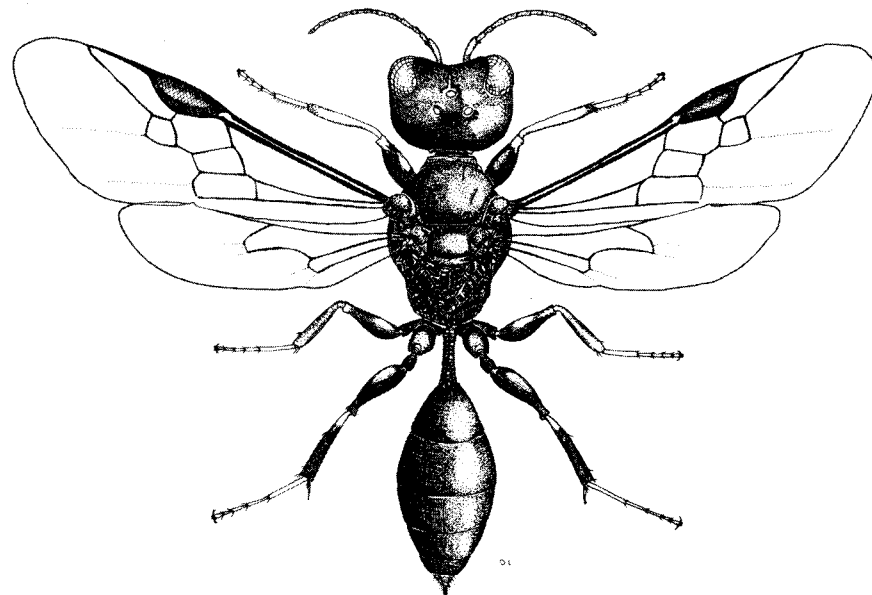

Fig. 166. Female of *Stigmus solskyi* A. Mor. Length: 3.5-5 mm.

a deep semi-circular emargination (Fig. 168). Frons between eyes with a trough-like depression, dull, strongly microsculptured. The furrow running parallel to the orbits posteriorly deeply excavate and with closely-spaced transverse carinae in the bottom. Thorax as in female, but with somewhat stronger microsculpture.

Not common, but widely distributed in Fennoscandia and Denmark. - Denmark: apparently absent from western and northern Jutland. - Sweden: sparse distribution through Götaland and Svealand. - Norway: a few specimens from AK and AAy. - Finland: distributed over large parts of the country; northern distribution limit in Kb. - Soviet Karelia: Ib and Kr. - The species is known mainly from Central and northern Europe, eastwards to Kazakhstan.

The species has been found breeding in branches, e. g. of Sambucus, Prunus and Malus, but also in abandoned tunnels of Anobium (Col., Anobiidae). When the tunnel system is constructed in stems with soft pith or in decayed wood, a great number of short side tunnels often proceeds from the main zig-zag tunnel, each of them ending in a single cell. The prey consists of aphids (Aphididae), each cell being provisioned with 10-20 specimens. The larva was described by Janvier, 1962.

38. STIGMUS PENDULUS Panzer, 1804

Fig. 169.

Stigmus pendulus Panzer, 1804: H. 86, T. 7.

Female: 4-5.5 mm. The two teeth-like projections on anterior border of clypeus stronger and broader than in solskyi, whereby the emargination between them is narrower. Pubescence of clypeus distinctly sparser than in solskyi. Frontal furrow very well developed and deeply excavate. Antennal segment 4 distinctly longer than 5. Humeral tubercle black or brown-black. Scutum and scutellum shining, with only an indication of microsculpture. Area above the dorsal of the two horizontally running furrows on mesopleuron smooth, only rarely slightly rugose. Mesopleuron in front of coxa 2 shining.

Male: 3.5-4.5 mm. Head in front view (Fig. 169) relatively broader than in solskyi. Frontal furrow more strongly developed, on either side of this is a convexity. Anterior border of clypeus either squarely truncate or weakly arcuate-emarginate (Fig. 165). Microsculpture of head much weaker than in solskyi, whereby the surface is much more shiny. Orbits posteriorly with only an indicated division into cavities. Thorax shining, sculpture almost as in female.

This species has a remarkable distribution: in Sweden mainly in Götaland

and Svealand. - Norway: only known from AAy, Arendal. - Finland: very limited material from N. - Also found rarely in Europe. In Germany the species is found near Husum in Schleswig, and it might be expected to occur in southern Jutland.

The nest of this species may be found in stems, e. g. of Rubus fruticosus, where the main tunnel - if allowed by the thickness of the branch - runs like a spiral. The cells are usually constructed two in a line in short side tunnels, running parallel to the longitudinal axis of the branch close under the bark. Each nest may contain up to 14 cells. The fully grown larva was described by Janvier, 1962 and by Maneval, 1939. Provision consists of Aphididae, e. g. Myzus lythri (Schrank), of which about 25 are placed in each cell. Perithous mediator Grav., P. divinator (Pimplinae) and Diomorus armatus Boh. (Torymidae) are known as parasites.

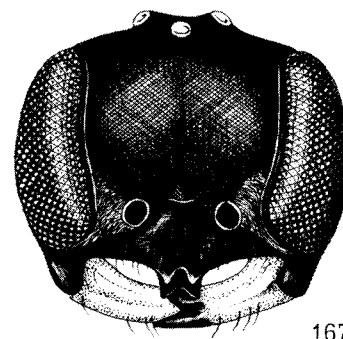

167

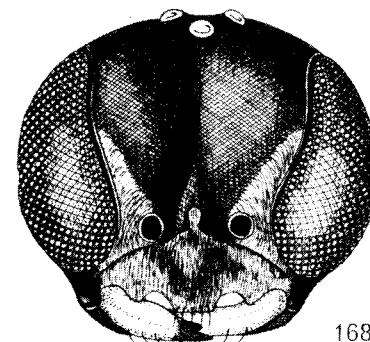

168

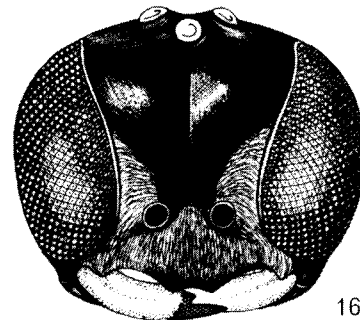

169

Figs. 167-169. Heads in frontal view of Stigmus. - 167: solskyi A. Mor., ♀; 168: same, ♂; 169: pendulus Panz., ♂.

## Genus *Spilomena* Shuckard

*Spilomena* Shuckard, 1838: 79.

*Celia* Shuckard, 1837, preoccupied.

Type-species: *Stigmus troglodytes* van der Linden, 1829.

Very small, slender species (Fig. 170), whose maximum length does not exceed 3.5 mm. Head in front view (Figs. 171-175) usually almost circular, eyes weakly convex. Clypeus narrow, its middle part strongly convex, the anterior border only slightly projecting. Mandibles bidentate. Antennae inserted far down on frons. Distance from antennal sockets to anterior border of clypeus less than diameter of sockets. Pronotum with strong transverse carina, often with a central, narrow interruption. Thorax, except propodeum, weakly sculptured, often rather shining, usually with distinct microsculpture. Area cordiformis usually with costae, generally on finely reticulate ground. Propodeum laterally and posteriorly usually with fine striae or rugae. Abdomen sessile, shining, with only extremely sparse pubescence apically. A true pygidial area is missing. Forewings with a very large stigma, two cubital and a single discoidal cell (Fig. 170). Tarsus 1 without pecten. Tibia 2 with a single spur. Tibia 3 without spines on the outer side. Face of males with yellow or whitish pattern.

Without material for comparison the species may be extremely difficult to identify correctly. This applies especially to small individuals and to the males of *vagans* and *troglodytes*. It is recommended to use times 100-150 magnification for identification.

The genus has a cosmopolitan distribution. Nine species in Europe. The species nest in pith-filled plant stems or abandoned larval tunnels of small xylophagous Coleoptera. The species may occur in great numbers locally.

### Key to species of *Spilomena*

Females

- |   |   |   |
|---|---|---|
| 1 | Clypeus at least anteriorly with a longitudinal furrow (Fig. 171). Transverse furrow of scutellum deeply pitted .....                     | 2 |
| - | Clypeus without longitudinal furrow. Transverse furrow of scutellum smooth at bottom or with very weakly indicated transverse rugae ..... | 3 |

- |      |   |                               |
|------|---|-------------------------------|
| 2(1) | Head behind eyes strongly narrowed (Fig. 178)<br>Ocelli form an acute angle .....   | 39. <i>differens</i> Blüthgen |
| -    | Head behind eyes longer, more weakly narrowed posteriorly (Fig. 180). Ocelli form an obtuse angle .....   | 40. <i>curruca</i> (Dahlbom)  |
| 3(1) | Head behind eyes strongly developed. Smallest distance from inner orbit to a lateral ocellus 2.5-3 times the distance between lateral ocelli (Fig. 182). Tergum 6 usually with two distinct, well separated longitudinal keels (Fig. 190) ... | 41. <i>enslini</i> Blüthgen   |
| -    | Head behind eyes shorter and more narrowed posteriorly. Smallest distance from inner orbit to a lateral ocellus at most 2 times the inter-ocellar distance. Tergum 6 flat or with two very weakly marked longitudinal keels .....             | 4                             |
| 4(3) | Tergum 6 without keels. Sculpture of scutellum like that of scutum, with distinct microsculpture,   |                               |

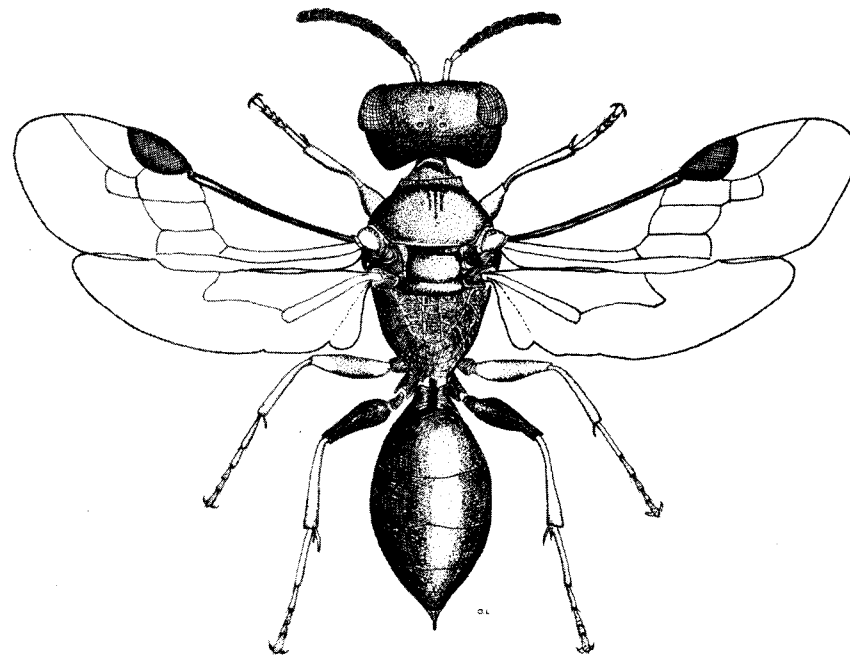
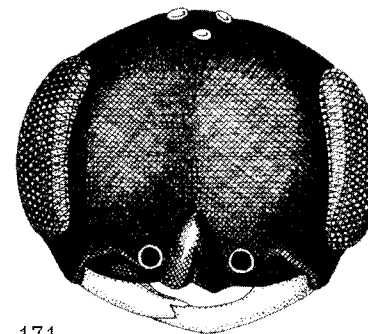

Fig. 170. Female of *Spilomena vagans* Blüthgen. Length: 2.5-3 mm.

- including the central part. Mesopleuron dull, distinctly but finely rugulose. Propodeum dorsally shining, with coarse rugae ..... 42. expectata Valkeila
- Tergum 6 compressed, with one or two weak keels. Scutellum shining in middle, with or without very weak microsculpture. Mesopleuron smooth, strongly shining. Propodeum dorsally with weak rugae, interstices with finely but distinctly reticulate microsculpture ..... 5
- 5(4) Transverse carinae between the two dorsal, longitudinal ribs on propodeum very weak or absent. Head seen from above very short (Fig. 187). Legs brown or pale brown-yellow, femora lighter or darker brown ..... 43. troglydytes (v. d. Linden)
- Transverse carinae between the two dorsal longitudinal ribs on propodeum distinct, varying in number from 5-6. Head seen from above longer (Fig. 185). Tibia 1 and tibia 2 strongly red-yellow, usually almost uniform coloured ..... 44. vagans Blüthgen
- Males
- 1 Transverse furrow of scutellum with distinct transverse carinae, dividing it into a row of quadrate pits (Figs. 176, 177). Only anterior border of clypeus whitish (Figs. 172, 173) ..... 2
- Transverse furrow of scutellum at bottom smooth, without transverse carinae. Whole clypeus yellow or whitish ..... 3
- 2(1) Transverse furrow of scutellum strongly pitted (Fig. 176). Head seen from above strongly developed posteriorly (Fig. 179), in front view comparatively broad (Fig. 173) ..... 39. differens Blüthgen
- Transverse furrow of scutellum with weaker pits (Fig. 177). Head seen from above shorter (Fig. 181), in front view somewhat narrower (Fig. 172) ..... 40. curruca (Dahlbom)
- 3(1) Vertex very strongly developed (Figs. 183, 189). Distance between posterior ocelli as great as or slightly greater than the diameter of an ocellus. 41. enslini Blüthgen

- Head shorter posteriorly, considerably more weakly developed. Distance between posterior ocelli considerably larger than diameter of an ocellus .....

4



171

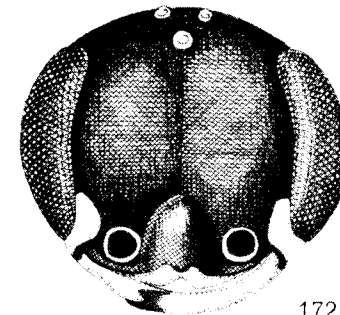

172

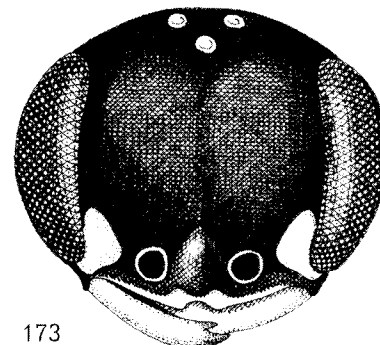

173

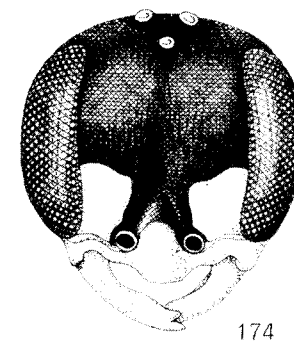

174

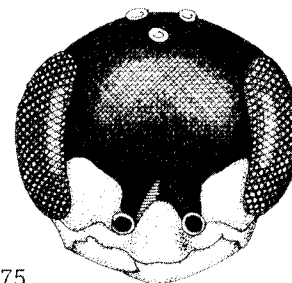

175

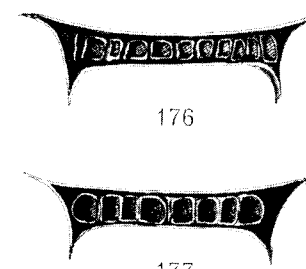

176



177

Figs. 171-175. Heads in frontal view of Spilomena. - 171: curruca (Dahlbom), ♀; 172: same, ♂; 173: differens Blüthgen, ♂; 174: expectata Valkeila, ♂; 175: vagans Blüthgen, ♂.  
Figs. 176, 177. Transverse furrow of scutellum in male Spilomena. - 176: differens Blüthgen; 177: curruca (Dahlbom).



4(3) Legs and flagellum usually uniform red-yellow or yellow-brown. Median flagellar segments thickened, whereby flagellum obtains a moniliform appearance (Fig. 191). Head in front view broader than high (Fig. 175), seen from above as Fig. 186. Head around the mandibular articulations with a large yellow spot ..... 44. vagans Blüthgen

- All femora, and usually also flagellum, brown coloured. Flagellar segments not, or only weakly dilated. Head narrower, around the mandibular articulations usually without yellow spot .....

5(4) Head seen from above posteriorly very strongly narrowed (Fig. 188). Frons slightly convex. Flagellar segments slightly thickened ventrally. Habitus comparatively long and slender. 43. troglodytes (v. d. Linden)

- Head seen from above as Fig. 184, frons almost straight. Flagellar segments very slightly thickened (Fig. 192). Habitus shorter and broader. 42. expectata Valkeila

39. SPILOMENA DIFFERENS Blüthgen, 1953  
Figs. 173, 176, 178, 179.

Spilomena differens Blüthgen, 1953: 173.

Female: 2.8-3.3 mm. Head seen from above as Fig. 178. Microsculpture on head and scutum weak, punctation very fine. Clypeus with distinct depressed midline and rather strong, angular emargination in anterior border. Mandibles and scapus brown, flagellum darker. Humeral tubercle posteriorly very slightly paler. Transverse furrow of scutellum divided into coarse, almost quadrate pits. Scutum posteriorly with very fine oblique rugae. Mesopleuron shining, smooth, with only indicated sculpture. Dorsal propodeal carinae usually distinct, the longitudinal ones usually somewhat irregular, not parallel. Anterior half of sides of propodeum plane, smooth, shining and without sculpture; posterior area with coarse, irregular rugae. Posterior face with distinct transverse carinae. Tergum 6 posteriorly with two slightly elevated longitudinal ribs, slightly diverging anteriorly. Femora dark brown, tibiae and tarsi paler.

Male: 2.5-3.0 mm. Only anterior border of clypeus whitish. Spots along lower orbits small, whitish. Mandibles and scapus yellowish (Fig. 173).

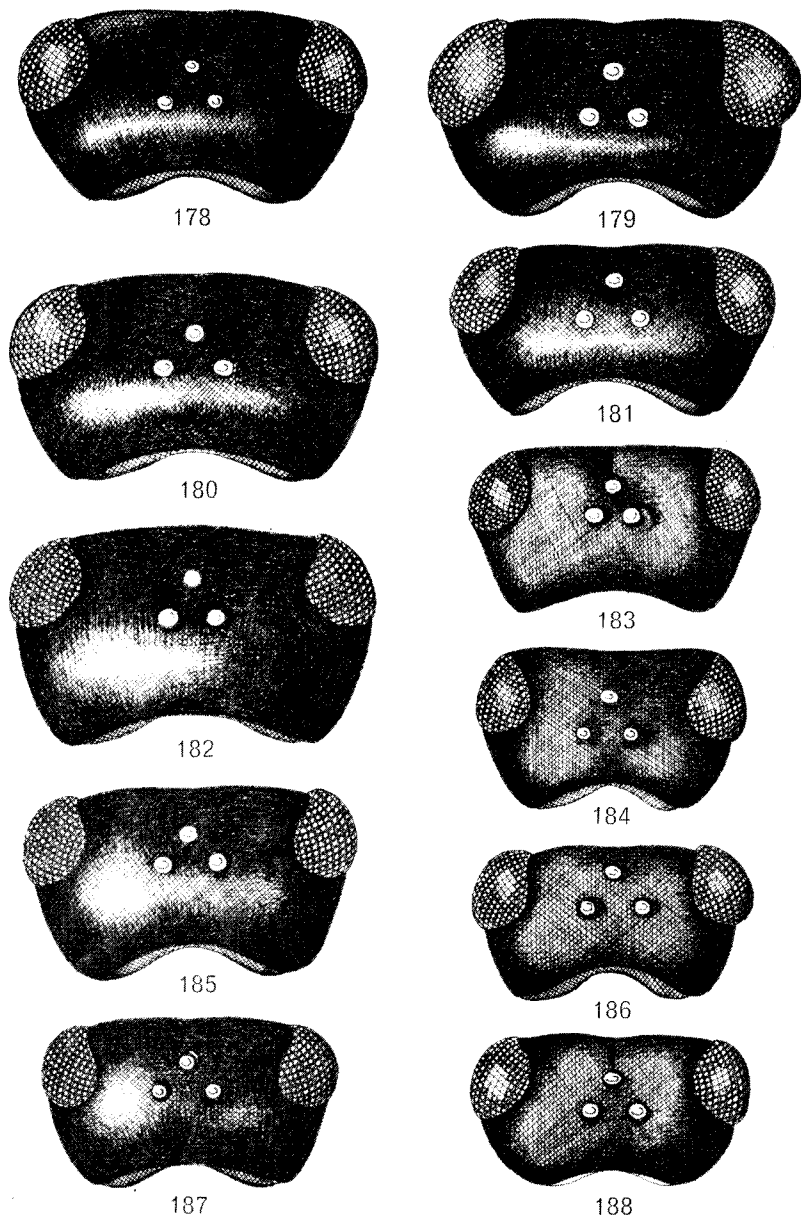

Figs. 178-188. Heads in dorsal view of Spilomena. - 178: differens Blüthgen, ♀; 179: same, ♂; 180: curruca (Dahlbom), ♀; 181: same, ♂; 182: enslini Blüthgen, ♀; 183: same, ♂; 184: expectata Valkeila, ♂; 185: vagans Blüthgen, ♀; 186: same, ♂; 187: troglodytes (v. d. Lind.), ♀; 188: same, ♂.

Transverse furrow of scutellum with distinct pits (Fig. 176). Oblique rugae at the posterior border of scutum very indistinct. Mesopleuron as in female. Carinae of propodeum somewhat irregular. Legs light yellow-brown. Hind femora usually brown.

Not common, but widely distributed in the area. - Denmark: not known from Jutland. - Sweden: from Sk. in the south to Vrm. and Gstr. in the north. - Norway: a single female from AK, Bygdeø. - Finland: distributed mainly in the southern districts; northernmost localities in Kb. - Distribution area: Europe.

The nests are constructed in the same habitats as described under vagans, i. e. in abandoned tunnels of xylophagous insects, especially Anobiidae. There is only a single comparatively detailed description (Valkeila, 1957) with a statement of number of cells, branched tunnel system, prey (Thysanoptera) and separation of cells by means of compacted wood dust.

#### 40. SPILOMENA CURRUCA (Dahlbom, 1843)

Figs. 171, 172, 177, 180, 181.

Celia curruca Dahlbom, 1843: 239.

Female: 2.5-3.0 mm. Closely related to differens, but besides the characters mentioned in the key, recognizable by the longer hairs on frons. Mesopleuron with very weak rugae and extremely fine punctation, pubescence more distinct. Pits in transverse furrow of scutellum rectangular. Tergum 6 with at most very weak longitudinal carinae. Legs of same colour as in differens.

Male: 2.3-2.8 mm. Only anterior part of clypeus whitish. The small spots along lower orbits also whitish. Head seen from above posteriorly strongly narrowed (Fig. 181). Very similar to differens, from which it can only be distinguished by the characters mentioned in the key, and by its somewhat more slender habitus.

This species is known only from Fennoscandia and Soviet Karelia. - Sweden: a few specimens from Sm. (Dahlbom), Ög., Nrk., Upl. and Vb. - Norway: NTi, Thynæss (Dahlbom). - Finland: N, Ta, Sa, Ok. - Soviet Karelia: Ib.

May be found nesting in old, partly decayed trees, e. g. Salix alba or in other wood-work (Valkeila, 1957).

#### 41. SPILOMENA ENSLINI Blüthgen, 1953

Figs. 182, 183, 189, 190.

Spilomena enslini Blüthgen, 1953:174.

Female: 2.8-3.3 mm. Very easily recognizable by the large, posteriorly strongly-developed head. Frons comparatively shining, microsculpture weak. Median part of clypeus almost plane, very weakly longitudinally striate. Anterior border distinctly angularly or arcuately incised, without longitudinal furrow. Mandibles brown. Antennae a little paler. Humeral tubercle black, only slightly lighter posteriorly. Microsculpture of scutum and scutellum hardly visible, punctation on the other hand distinct, but very fine. Transverse furrow of scutellum smooth at bottom. Mesopleuron with weak, reticulate microsculpture, which in front of coxa 2 is stronger, forming weak striation. Propodeum dorsally with rather strongly-projecting carinae and costae on an almost shining ground, as the microsculpture has practically disappeared. The longitudinal carinae usually somewhat irregular, slightly shortened. Striation of lateral and posterior faces of propodeum very fine, almost vestigial. Tergum 6 with two parallel, well-separated carinae (Fig. 190), surrounded by a weak, thin pubescence. Femora dark-brown, tibiae and tarsi paler.

Male: 2.4-2.9 mm. Characterized by the large vertex (Figs. 183, 189). Clypeus, mandibles, two big spots on lower part of face along inner orbits and scapus white-yellow. Flagellum pale yellow-brown or red-brown. Microsculpture on upper part of head and scutum comparatively weakly developed. Punctation indistinct. Costae in area cordiformis irregular, usually somewhat shortened. Legs light red-yellow, femur 3, however, distinctly darkened.

Locally rather common in Fennoscandia. - Denmark: nests in Sambucus only found in NEZ, (Brede). - Sweden: Sm., Öl., Ög., Vg., Nrk. and Gstr.

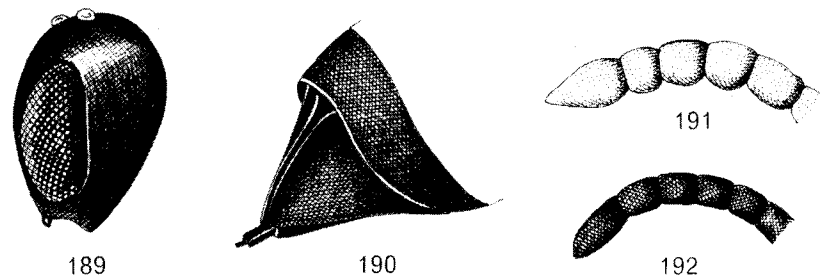

Figs. 189-190. Spilomena enslini Blüthgen. - 189: head in lateral view of  $\sigma$ ; 190: apex of abdomen in lateral view of  $\text{♀}$ . Figs. 191-192. Antennae of male Spilomena. - 191: vagans Blüthgen; 192: expectata Valkeila.

- Not recorded from Norway. - Finland: Ab, Ta, Sa and Kb. - Northern and Central Europe.

The nests are excavated in pith-filled stems of Rubus idaeus and Sambucus nigra. If there is sufficient space, a branched tunnel system is constructed. Mode of construction very similar to that of the species of Rhopalum. The diameter of the main tunnel varies between 1.2 and 1.5 mm. The diameter of the cells is almost constant, being 1.5 mm. Partitions between cells are made of dust more or less compacted.

Frankliniella intonsa (Thysanoptera) may be used as prey. The following Hymenoptera are known to occur as parasitoids in this species: Neorhacodes ensilini (Rusch.) (Ichneumonidae), Lonchetron fennicum Grah. (Pteromalidae), Kaleva livida Grah. (Pteromalidae), Eupelmella vesicularis (Retz.) (Eupelmidae) and Leptocryptus geniculatus Thoms. (Cryptinae).

42. SPILOMENA EXSPECTATA Valkeila, 1957

Figs. 174, 184, 192.

Spilomena exspectata Valkeila, 1957: 164.

Female: 2.8-3.0 mm. Head seen from above rather strongly developed posteriorly, above mainly dull owing to the strong microsculpture. Punctuation hardly visible. Mandibles and scapus brown, flagellum black. Clypeus in middle without longitudinal furrow, anterior border not, or only very weakly, emarginate. Transverse carina of pronotum not interrupted in middle. Humeral tubercle black. Scutum and scutellum with very uniform and rather strong microsculpture and with fine, but distinct punctuation. Anterior transverse furrow of scutellum smooth at bottom. Mesopleuron with distinct, very slightly undulating transverse striation, as the microsculpture is partly coalesced. Propodeum dorsally shining, smooth due to the almost vestigial microsculpture. Costae well developed, also posteriorly. Costae on the lateral areas of propodeum, however, somewhat shortened. Tergum 6 without projecting keels or carinae, evenly rounded with a short and very dense pubescence apically. Femora dark brown, tibia 1 red-brown, tibia 2 and tibia 3 brown with lighter apex.

Male: 2.5-2.8 mm. Microsculpture of head very distinct. Clypeus, mandibles, scapus ventrally and a large spot along inner orbits light yellow (Fig. 174). Flagellum brown, ventrally lighter. Segments 6-11 very slightly dilated. Scutum and scutellum dull with distinct microsculpture. Costae dorsally on propodeum sharp, on almost shining ground.

Only known from Fennoscandia and Denmark. - Denmark: a single female from EJ, Molslaboratoriet. - Sweden: widely distributed, but not common, northerly to Gstr. - Not recorded from Norway. - Finland: Ab, Masku (type locality), St and Ta.

The nests are constructed in hollow or soft pith-filled plant stems, e.g. Sambucus or Rubus. They consist of a combination of linear and branched types, the first constructed cells lying in a row, while those built later are placed next to the main tunnel at the end of a short side tunnel. Provision consists of Thysanoptera nymphs. The cocoon is thin-walled and not lined with bore-dust or the like, as is the case in vagans and differens.

Note: S. exspectata is very close to S. beata Blüthgen from Central and South Europe. The two species can be separated by the following characters (Valkeila, 1961):

Head more cubic. Face, and especially clypeus, distinctly convex. Propodeum with comparatively weaker and denser sculpture . . . . . beata Blüthgen

Head less cubic. Face and clypeus more even. Propodeum stronger and more sparsely sculptured . . . . . exspectata Valkeila

43. SPILOMENA TROGLODYTES (van der Linden, 1829)

Figs. 187, 188.

Stigmaus troglodytes van der Linden, 1829:74.

2.7 - 3.0 mm. Very close to vagans, from which in most cases it can be distinguished by the characters mentioned in the key. Colour of legs very variable as in vagans, but no specimens with red-yellow femora are known. The carina surrounding area cordiformis often much reduced, as are also the longitudinal and transverse carinae. Propodeum laterally and posteriorly very finely, often somewhat irregularly striate. Pterostigma usually often paler than in vagans, habitus somewhat more slender, and microsculpture of head somewhat weaker. Flagellar segments of males only slightly dilated.

Denmark: three females are known from NEZ, Hellerup. - Sweden: Sk., Nrk., Sdm., Upl. and Gstr. - Not found in Norway. - Finland: only recorded from Tb. - The species is widespread in Europe and seems to have a slightly more southern distribution than vagans.

The species breeds in available cavities in old timber. Deserted burrows of Anobium spp. are preferred. Nests in thatched roofs are also recorded. The selected Anobium tunnels are cleaned, loose bore-dust being removed,

and provisioning started. Prey consists of Thysanoptera nymphs, which are carried to the nest in the mandibles. It is noteworthy that when returning with the prey, the females run about for a rather long time, before they find the entrance to the nest (this seems to be a usual feature within the species of Spilomena). The nest is of the linear type. Each cell contains 50-60 thrips. The egg is comparatively large, 1.25 mm long, weakly curved and sausage-shaped. When the whole tunnel system is fully provisioned, the entrance is closed with a plug of bore-dust, firmly compacted with the abdomen. The outermost part of the plug consists of a mixture of saliva and fine dust, which hardens into a slightly shining disc.

The males are found swarming round bushes and trees, often resting or sucking honey dew on the leaves. Neorhacodes inslini Rusch (Hym., Ichneumonidae) is known as parasitoid.

44. SPILOMENA VAGANS Blüthgen, 1953

Figs. 170, 175, 185, 186, 191.

Spilomena vagans Blüthgen, 1953:272.

Female: 2.5 - 2.9 mm. Head seen from above as Fig. 185, in front view rather shining, slightly wider than high. Clypeus anteriorly with weakly arcuately or angularly emargination, without longitudinal furrow. Mandibles and scapus usually pale red-yellow, but individuals with brown scapus occasionally occur. Flagellum lighter or darker brown, usually with light spots ventrally, especially proximally. Humeral tubercle posteriorly with a light brown or yellow spot. Transverse furrow of scutellum smooth at bottom, without transverse carinae. Propodeum dorsally (area cordiformis) usually surrounded by U-shaped, slightly elevated carina, which may be reduced. The two parallel longitudinal carinae posteriorly reaching this, are connected with each other by distinct, but often irregular, transverse ribs. From the longitudinal carinae issue, in addition, oblique rugae. Lateral and posterior faces of propodeum with distinct, regular striation. Tergum 6 posteriorly with two very closely-placed, weak, longitudinal carinae, partly concealed by a dense, short pubescence. Forelegs usually completely uniform red-yellow or light brown-yellow.

Tibia 2 and tibia 3 of same colour, femora darker. Colour pattern very variable. Specimens from Finland often have almost uniformly clear red-yellow legs, mandibles and scapus. Danish and Swedish specimens usually have femora considerably darker than tibiae, and often dark mandibles and scapus.

Male: 2.3 - 2.7 mm. Sculptured as female, but more weakly. Whole clypeus yellow or white-yellow. Spots on lower parts of face of varying size, but always comprising the whole area round mandibular articulations.

Mandibles and scapus yellow. Median flagellar segments distinctly thickened

(Fig. 191). Legs and scapus often uniform light red-yellow. Specimens with considerably darker flagellum, femur 2 and femur 3 are known from Denmark and southern Sweden. Sculpture on propodeal dorsum distinct. Larva described by Valkeila, 1957.

The species is found in all Nordic countries. - Denmark: not common, E.J., LFM, NEZ. - Sweden: distributed from Sk. to Dlr. and Hls. in the north. - Norway: a very limited material from AAY, Aurdal. - Finland: often found in great numbers on log-houses. Common in the southern districts, northernmost localities in Kb. - Not common in Europe.

No doubt this species is the most commonly occurring Spilomena in Fennoscandia and Denmark. The females are often met with on sheds and walls or other old timber exposed to the sun, in which abandoned tunnels of e. g. Anobium, Anthraxia or Callidium are plentiful. The males are found swarming round sunlit bushes or resting on leaves. The cells are constructed in the dust at the end of short side tunnels. The cocoon is covered with wood debris.

## TRIBE PSENINI

The Psenini comprises the following Nordic genera: Mimesa, Psen, Mimemesa and Psenulus. Inner orbits parallel or diverging ventrally. Frons usually with a longitudinal carina that sometimes joins a transverse carina below the antennal sockets. Antennae more or less clavate, inserted relatively high up on frons. Epicnemial furrow and/or carina present, epicnemium present. Abdomen petiolate, the petiolus formed by sternum 1 alone. Females often with a pygidial area (indistinct in Psenulus). Tarsal pecten usually distinct in females. Forewings with three cubital and two discoidal cells.

Larvae. Parietal bands weak or absent. Antennal papillae present. Mandibles elongate or, in Psenulus, short and heavy, apex with three or four teeth. Galea considerably smaller than the maxillary palpus, vestigial in several species. The spinneret larger than the labial palpus, acute or truncate apically, the openings completely separate.

The tribe comprises 28 genera of which 10 occur in Europe. Most species are arboreal, but terrestrial nesting habits are found in Mimesa and Psen. Homoptera is the main source of prey.

## Genus Mimesa Shuckard

Mimesa Shuckard, 1837:228.

Type-species: Trypoxylon equestre Fabricius, 1804.

The Danish and Fennoscandian species (Fig. 193) are easily distinguishable by the red colour pattern proximally on the abdomen. On the anterior side of the head the carina, issuing in front of the median ocellus, is very short and may be missing. Between the antennal sockets there is a round swelling, and the transverse carina is absent. Just behind the anterior border of clypeus there is a transverse raised area, which may be divided into two parts, or it may be very weakly developed in the males. Secondary sexual characters are often found on the underside of the antennae, especially as longitudinal pads (tyloidea) in the males. In the forewings first and second discoidal transverse veins join the second cubital cell. Mesopleuron microsculptured, dull, distinctly punctate. The acetabular suture is missing. Petiolus often sharp-edged. As in *Mimumesa* a longitudinal swelling may occur dorsally on the petiolus, but this is rarely distinctly marked. Laterally on petiolus is a row of projecting white hairs. Females with pygidial area.

Distributed in the Nearctic as well as in the Palaearctic regions, where about 40 species occur. In Europe there are about 10 species. The species construct their nests mainly in sandy soils. The larvae are provisioned with Psyllidae and small cicadas.

Key to species of Mimesa.

Females

- 1 Petiolus flattened or concave dorsally, ventrally sharp-edged to base, breadth seen from above considerably larger posteriorly than anteriorly (Figs. 194, 197). Tergum 3 completely black ..... 2
- Petiolus convex dorsally or with longitudinal pad. Anterior half of ventral side rounded. Tergum 3 more or less red ..... 3
- 2(1) Petiolus long, longer than tergum 1 (Fig. 197). The latter with a large black spot. Metatarsus 1 light brown-yellow. Length of tarsal spines 3/4 of the breadth of metatarsus 1 ..... 47. *bruxellensis* Bondroit
- Petiolus as long as tergum 1, the latter completely red (Fig. 195). Metatarsus 1 brown, tarsal spines shorter than half breadth of metatarsus 1. 46. *lutaria* (Fabricius)
- 3(1) Petiolus seen from above as long as, or slightly longer than tergum 1, distinctly increasing in breadth posteriorly (Fig. 194). Tergum 1

- usually without black spot. Mesopleuron densely, but finely and distinctly punctate ..... 48. *rufa* (Panzer)
- Petiolus seen from above distinctly longer than tergum 1, usually with parallel sides (Fig. 196). Tergum 1 usually with a large black or brown-black anterior spot. Mesopleuron with extremely fine and sparse punctation ..... 45. *equestris* (Fabricius)

Males

- 1 Antennal segments 4-7 ventrally with a distinct smooth longitudinal pad or only with hairless convexities (Fig. 199) ..... 2
- Antennal segments with quite even and dense pubescence, without swellings of any kind (Fig. 200) ..... 3
- 2(1) Petiolus dorsally plane or weakly convex, considerably increasing in breadth posteriorly (Fig. 195). Terminal antennal segments distinctly longer than broad ..... 46. *lutaria* (Fabricius)

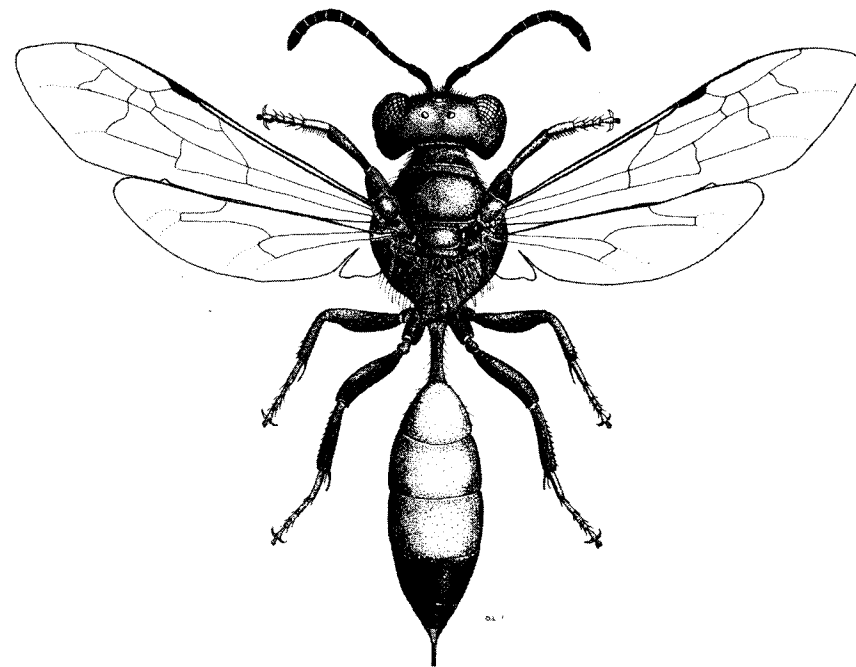

Fig. 193. Female of *Mimesa rufa* (Panz.). Length: 6-10 mm.

- Petiolus convex dorsally, its sides almost parallel (Fig. 196). Terminal antennal segments as long as broad or even broader than long ..... 45. equestris (Fabricius)
- 3(1) Mesopleuron rugoso-punctate, with very distinct microsculpture. Antennal segments 11 and 12 broader than long ..... 48. rufa (Panzer)
- Mesopleuron evenly punctate (as in lutaria). Punctures never coalescing or forming rugae, except in area immediately below base of forewings. Antennae long and slender, all segments longer than broad (Fig. 200) ... 47. bruxellensis Bondroit

45. MIMESA EQUESTRIS (Fabricius, 1804)

Fig. 196.

Trypoxylon equestre Fabricius, 1804:182.

Psen (Mimesa) bicolor auctt.

Female: 6-9 mm. Clypeus with silvery or weakly gold-shining pubescence, its transverse raised area strong. Scutum very evenly and regularly punctate with distinct microsculpture. Mesopleuron very finely and very sparsely punctate. Area below base of forewings often striate. Rugae of propodeum as in rufa. Petiolus long, convex dorsally. Tergum 1 usually with a large brown-black spot (Fig. 196). Anterior half of tergum 3 reddish coloured. Tarsus 1 of same colour as tibia 1.

Male: 5-8 mm. Pubescence of clypeus as in female. Scutum finely and sparsely punctate with or without very fine microsculpture. Mesopleuron with extremely fine and sparse punctation, with or without very fine microsculpture. Area just below base of forewings strongly striate. Tergum 1 with a large, brown-black spot, tergum 2 mainly red, tergum 3 completely black. Tibia 1 brown-yellow, femur 1 black-brown. Central antennal segments with round tyloidea.

Rather common in Fennoscandia and Denmark. Northernmost records in Sweden: Nb. and Ly. Lpm., Norway: MRy, and in Finland: ObS and Ks. - Widely distributed in the Palaearctic region except North Africa.

Common in sandy localities. Main tunnel of nest often extending very deep (40-50 cm) vertically down into the ground. From the lower part issue branches, each ending in a nesting chamber. Small cicadas are used as food for the larvae. The species is often gregarious. The larva was described by Janvier (1955).

46. MIMESA LUTARIA (Fabricius, 1787)

Figs. 195, 199.

Sphex lutaria Fabricius, 1787:273.

Mimesa shuckardi Wesmael, 1852:278.

Aporia dispar Gussakovski, 1937:668.

Female: 7-9 mm. Clypeus with strongly shining pubescence, anteriorly with a fairly strong, transverse elevation. Anterior border with slight emargination. Frons in front of median ocellus densely and rather strongly punctate.

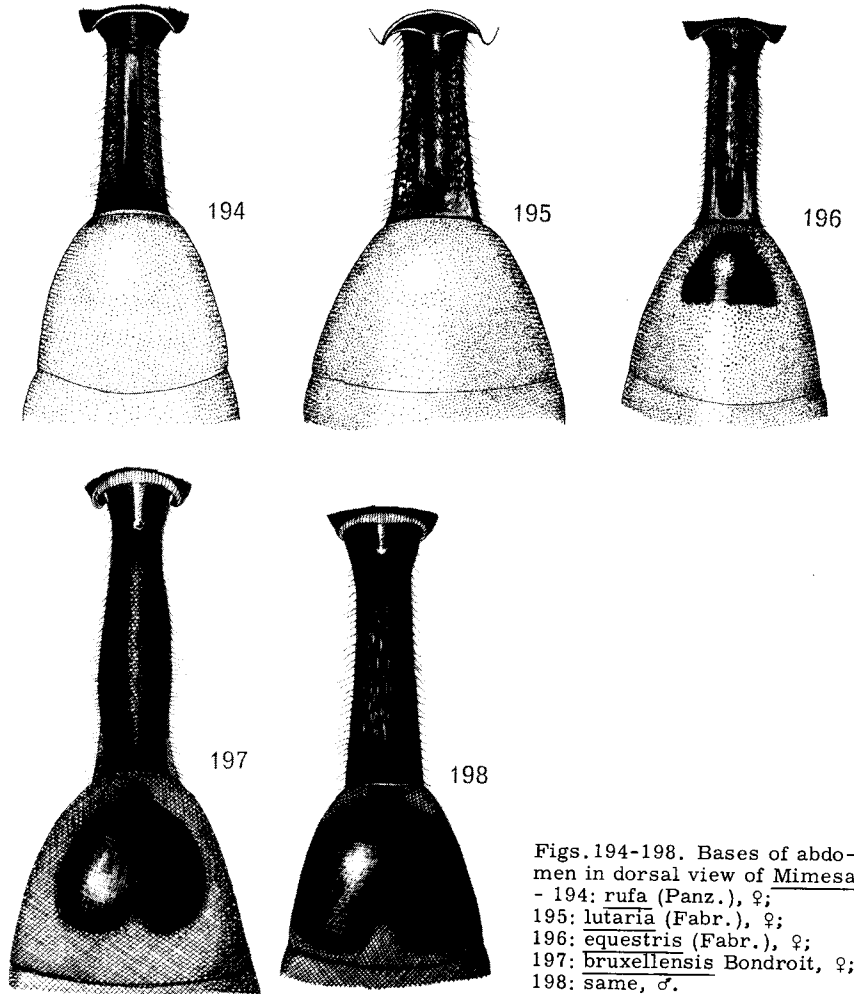

Figs. 194-198. Bases of abdomens in dorsal view of Mimesa. - 194: rufa (Panz.), ♀; 195: lutaria (Fabr.), ♀; 196: equestris (Fabr.), ♀; 197: bruxellensis Bondroit, ♀; 198: same, ♂.

Genae finely striate ventrally. Scutum with distinct microsculpture, with sparse punctation. Lateral areas of mesopleuron distinctly but finely and sparsely punctate, with microsculpture. Propodeum dorsally reticulate-rugose. Petiolus dorsally often with irregular, slightly undulating sculpture (Fig. 195), in cross section almost quadrate. Pygidial area broadly rounded at apex. Two first abdominal segments pure red coloured. Small specimens, especially from Norway, often have a brown spot on tergum 1. Tibia 1 brown, same colour as femur 1. Tarsus slightly paler.

Male: 7-9 mm. Pubescence of clypeus silvery. Frons in front of ocellus very densely rugoso-punctate. Microsculpture of scutum weak, hardly visible. Punctation rather sparse, somewhat irregularly distributed. Punctures on lateral parts of mesopleuron finer than those on scutum, but equally dense, with distinct microsculpture. Upper part immediately below base of forewings irregularly rugose. Propodeum coarsely reticulate-rugose. Tergum 1 red with a large brown-black spot. Two-thirds of tergum 2 red, remaining terga black. Individuals exist, in which the red colour on abdomen has almost completely disappeared. Antennae with distinct tyloidea (Fig. 199).

Rather common in Denmark, found in most districts. Widely distributed in Fennoscandia. Sweden: northern distribution limit in Nb. - Norway: to the north to Nnø. - Finland: northern records from Om and ObS. - Soviet Karelia: Ib and Kr. - Widespread throughout Europe. Also occurring in Japan. Will possibly be found in southern Siberia.

To be found in warm sandy places. Biology as in rufa, Omalus constrictus Forst. (Chrysididae) is recorded as predator.

47. MIMESA BRUXELLENSIS Bondroit, 1934

Figs. 197, 198, 200.

Mimesa bruxellensis Bondroit, 1934:61.

Aporia rossicus Gussakovski, 1937:669.

Very closely related to lutaria, but comparatively easily recognizable by its larger size.

Female: 9-10 mm. Transverse elevation on clypeus less conspicuous than in lutaria. Mesopleuron rather shining, weakly microsculptured. Punctation considerably more sparse and somewhat weaker than in lutaria. Petiolus longer than tergum 1 (Fig. 197), the latter with a brown-black spot. Tergum 2 posteriorly partly black. Tarsus 1 pale, of same colour as ventral face of antennae.

Male: 7-9 mm. Antennae very elongate, ventrally without tyloidea (Fig. 200). Petiolus much longer than tergum 1 (Fig. 198). Tibia 1 and tarsus 1 white.

A few records from Sweden: Sm., Södra Vi; Ög., Borensberg. - Finland: N, Hyvinkää (coll. Valkeila). - Soviet Karelia: Ib.

48. MIMESA RUFA (Panzer, 1805)

Figs. 193, 194.

Psen rufa Panzer, 1805: H. 96, T. 17.

Psen bicolor Jurine, 1807:137.

Mimesa equestris auctt.

Female: 6-10 mm. Pubescence of clypeus silvery or gold-shining. Transverse convexity behind its anterior margin weakly developed, anterior border hardly emarginate. Genae irregularly rugose, not actually striate. Punctation of head and scutum as in lutaria. Mesopleuron densely punctate, laterally with weak transverse rugae. Rugae of propodeum finer and more irregular than in lutaria. Punctures of pygidial area of irregular size. Petiolus dorsally weakly convex (Fig. 194). The two first segments and 2/3 of the third abdominal segment red. Tibia 1 bi-coloured, brown with light tip and base. Tarsus 1 as pale as ventral side of flagellum.

Male: 6-9 mm. Pubescence of clypeus silvery or weakly gold-shining. Frons in front of median ocellus finely rugoso-punctate. Punctation of scutum dense and rather strong, with distinct microsculpture. Mesopleuron very densely and strongly rugoso-punctate. The area just below base of forewings not differing in sculpture from remaining part of mesopleuron. Interspaces between the punctures and rugae distinctly microsculptured. Tergum 1 with a large brown-black spot, tergum 2 completely red. Tibia 1 brown-yellow, femur 1 black or black-brown.

A predominantly southern species in the North. - Denmark: probably occurring in all districts. - Sweden: rather common in the southern parts,

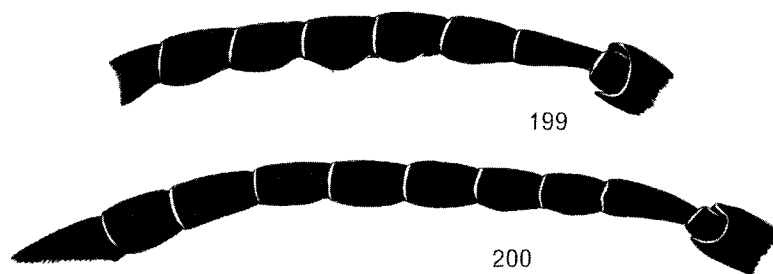

Figs. 199-200. Antennae of male Mimesa. - 199: lutaria (Fabr.); 200: bruxellensis Bondroit.

Sk., Sm., Öl. and Gtl. - Finland: very few records from Sa and Ks. - Soviet Karelia: Ib and Kr. - Rather common and widely distributed throughout Europe and Central Asia.

Found in sandy localities. The nests are constructed along paths and slopes, preferably below overhanging vegetation. They consist of a single unbranched tunnel, which most often extends 3-8 cm vertically down into the loose soil. The diet of the larva consists of Psylla (Psyllidae) and small cicadas. The species is gregarious, 20 specimens or more being often found together. Omalus constrictus Forst. (Chrysididae) is known as predator.

## Genus *Psen* Latreille

Psen Latreille, 1796:122.

Type-species: Sphex atra Fabricius, 1794 (= Crabro ater Olivier, 1792).

Rather large, generally uniformly black sphecids (Fig. 201). Head short. Lower part of face with well-developed, silvery shining pubescence. The narrow carina from the anterior ocellus ends in a spiny projection between the antennal sockets. The transverse carina anterior to the antennal sockets is weak. Anterior border of clypeus weakly bilobed without transverse elevation behind anterior margin. Antennae thickened distally, deeply excavate ventrally in males. Mandibles bidentate. First transverse discoidal vein joins second cubital cell, second the third. Petiolus considerably longer than tergum 1, slightly angular, cylindrical, dorsally without longitudinal convexity. Females with well developed pygidial area.

Cosmopolitan distribution. Total number of species about 40. Two species in Europe, only one in Fennoscandia.

The species nest in the ground. Larval diet consists of larger cicadas, e.g. Fulgoroidea.

49. PSEN ATER (Olivier, 1792)

Figs. 201 - 203.

Crabro ater Olivier, 1792:517.

Sphex atra Fabricius, 1794:457.

Female: 10-13 mm. Large, robust species. Head broad with very dense, silvery pubescence on lower face. Anterior border of clypeus sometimes light brown and translucent, weakly bilobed. A small, sharp spine between

antennal sockets. Scapus short and thick, distinctly curved. Mandibles red-brown with black base. Scutum sparsely but rather strongly punctate, without microsculpture. Mesopleuron smooth with only a very fine, sparse punctation. Propodeum posteriorly with coarse, irregular reticulation, on the sides smooth with superficial punctation and few, very short, transverse carinae. Petiolus much longer than tergum 1, smooth and without sharp edges, dorsally slightly convex, without sculpture, shining. Pygidial area broad with strong micro-sculpture and regular, coarse punctation.

Male: 9-12 mm. Pubescence of face and clypeus very dense, strongly silvery or weakly golden, shining. Frons between antennal sockets with a very small spine. Mandibles yellow with red tips. Antennae (Fig. 202) very characteristically formed: scapus strongly thickened, ampulla-shaped; flagellar segments strongly flattened and excavated ventrally; apical segments asymmetrical, dilated on inner side. Sculpture on thorax and propodeum as in female. Petiolus long, considerably longer than tergum 1. Tarsus 2 asymmetrically dilated (Fig. 203). Legs more or less yellow-brown.

Denmark: the record published by Nielsen (1907) can not be verified. - Sweden: a single female specimen from Upl., Vassunda. The record from southern Sweden by Aurivillius (1904) is doubtful. - Not recorded from Nor-

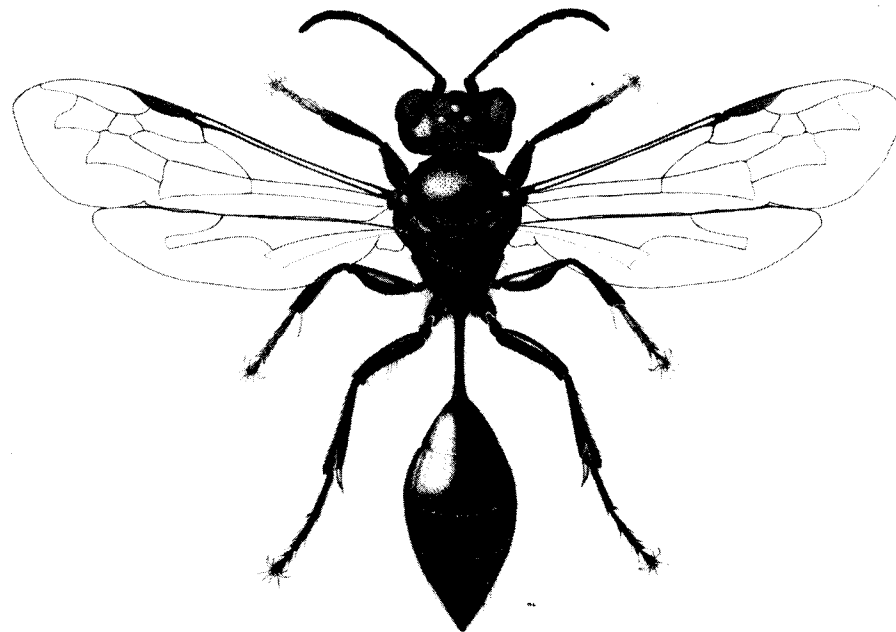
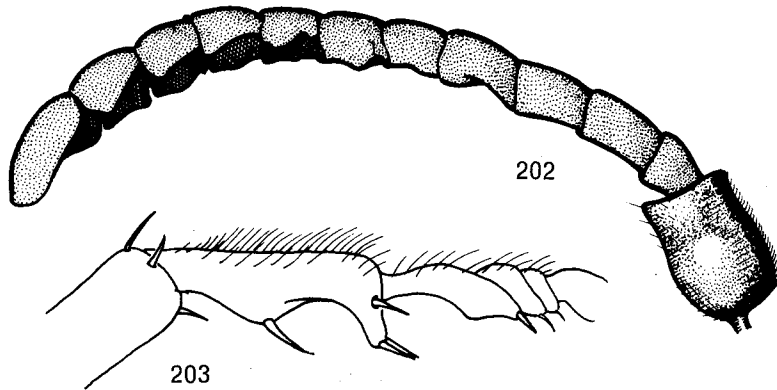

Fig. 201. Female of Psen ater (Oliv.). Length: 10-13 mm.



way or Finland.- The species is widely distributed in the Palaearctic region, eastwards to Japan.

Nests are found in sandy localities, often excavated in steep, sandy banks. From the main burrow - which may be up to 50 cm long - six to twelve short horizontal tunnels, each ending in a single cell, may be found. The prey consists of cicadas of the group Fulgoroidea, e. g. Issus coleoptratus Geoffr., Jassus lanio L. (Issidae) and Thamnotettix confinis (Euscelidae), of which 10 - 20 specimens are placed in each cell. The adult larva spins a cocoon, which is suspended almost in the middle of the cell. The larva was described by Janvier, 1955.



Figs. 202, 203. Psen ater (Oliv.). - 202: male antenna; 203: midtarsus of male.

## Genus Mimumesa Malloch

Mimumesa Malloch, 1933:16.

Type-species: Psen niger Packard, 1867.

Black, slender species (Fig. 204), which in habitus are very similar to Psen and Psenulus. Frons without spine between the antennal sockets. The longitudinal and transversal carinae on anterior surface of head weak. Anterior margin of clypeus weakly bilobed, no transverse convexity behind anterior margin. Anterior femora rounded. First and second discoidal transverse veins both run into second cubital cell. Mesopleuron smooth, shining. The ventral part of the epicnemial carina continues into the acetabular suture. Petiolus strongly angulate, dorsally with a strongly projecting longitudinal

pad, along which is placed a row of prominent, white hairs. Females with well developed pygidial area.

Distributed in the Holarctic and Indo-Australian regions with about 30 species. About ten species are found in Europe.

The species construct their nests in wood. The diet of the larvae consists of small cicadas.

### Key to species of Mimumesa

#### Females

- 1 Pygidial area narrow, its surface smooth with a row of large punctures along the margin (Figs. 217, 218). 2
- Pygidial area broad, dull, evenly punctate over the entire surface (Fig. 216) ..... 3
- 2(1) Epicnemium anteriorly delimited by a sharp carina, which forms an acute angle with the epicnemial carina close to the midline of mesopleuron (Fig. 214).

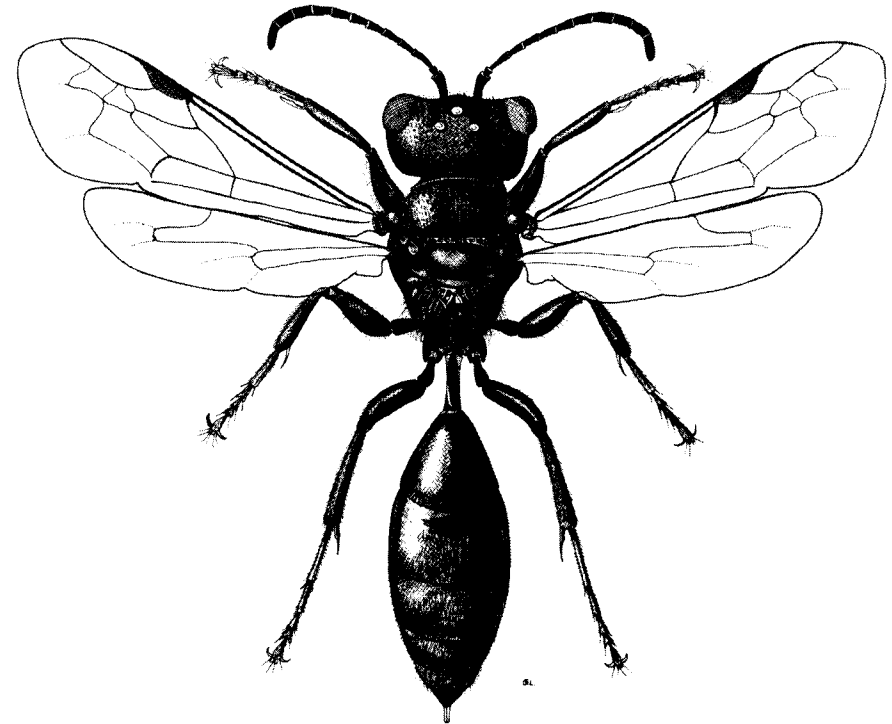

Fig. 204. Female of Mimumesa dahlbomi (Wesmael). Length: 7-9 mm.

Centre of clypeus strongly convex, longitudinally as well as transversely; silvery pubescence very sparse

54. dahlbomi (Wesmael)

Epicnemium anteriorly without delimiting carina (cf. Fig. 213). Clypeus weakly convex, silvery pubescence very dense

55. beaumonti (v. Lith)

3(1) Epicnemium anteriorly delimited by a sharp carina which forms an acute angle with the epicnemial carina close to the ventral midline of mesopleuron (cf. Fig. 214). Petiolus in lateral view considerably longer than tergum 1 (Fig. 209)

52. atratina (F. Morawitz)

Epicnemium anteriorly without delimiting carina. Petiolus in lateral view as long as or slightly longer than tergum 1

4

4(3) Central part of epicnemium forming a deep cup-shaped cavity, whose sides form an obtuse angle with the rest of the area (Fig. 215). The epicnemial carina strongly projecting. Punctuation on genae very fine, hardly visible at 50 x magnification. Silvery pubescence of clypeus sparse

53. spooneri (Richards)

Epicnemium almost plane without central cavity (Fig. 213). Epicnemial carina normally projecting. Punctuation on genae distinct, often coalesced into weak rugae. Silvery pubescence of clypeus thick

5

5(4) Petiolus as long as tergum 1 (Fig. 205). Pygidial area plane throughout. Frons anterior to the ocelli very densely punctate, punctures often coalescing, forming an irregular striation

50. unicolor (v. d. Linden)

Petiolus slightly longer than tergum 1 (Fig. 207). Pygidial area posteriorly distinctly convex. Punctuation of forehead fine and rather sparse, with smooth interstices

51. littoralis (Bondroit)

Males.

1 Epicnemium anteriorly delimited by a sharp carina, which forms an acute angle with the epicnemial carina near the ventral midline of mesopleuron (Fig. 214)

2

Epicnemium anteriorly without delimiting carina (Fig. 213)

3

2(1) Petiolus very long, longer than tergum 1 (Fig. 210) and than tibia 3. Tyloidea as in Fig. 221

52. atratina (F. Morawitz)

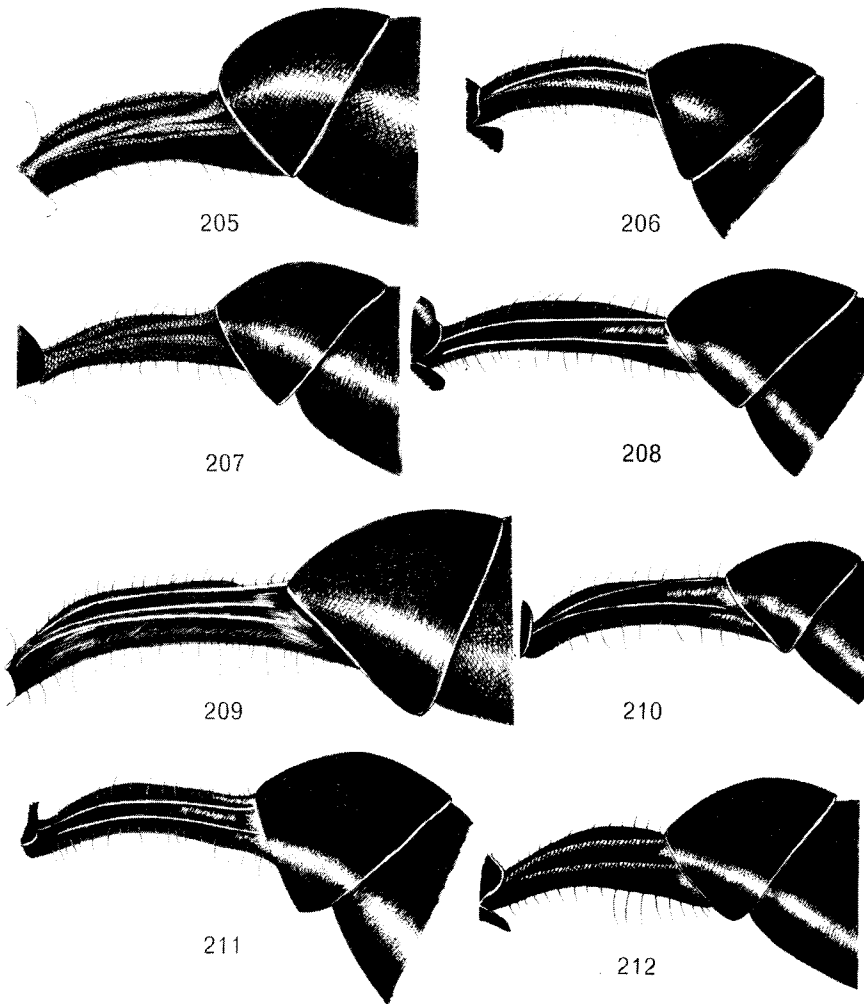

Figs. 205-212. Bases of abdomen in lateral view of *Mimumesa*. - 205: unicolor (v. d. Lind.), ♀; 206: same, ♂; 207: littoralis (Bondroit), ♀; 208: same, ♂; 209: atratina (F. Mor.), ♀; 210: same, ♂; 211: beaumonti (van Lith), ♂; 212: dahlbomi (Wesmael), ♂.

- Petiolus only slightly longer than tergum 1 and as long as tibia 3 (Fig. 212). Tyloidea as in Fig. 223..... 54. dahlbomi (Wesmael)
- 3(1) The central part of the epicnemium forms a deep concavity, whose sides form an acute angle with the surrounding area (Fig. 215). The distance from the eyes to the lateral ocelli almost as long as distance between ocelli ..... 53. spooneri (Richards)
- Epicnemium plane without concavity (in beaumonti, however, a very small central shallow excavation). Distance from eyes to lateral ocelli considerably longer than distance between ocelli ..... 4
- 4(3) Antennal segments 11 and 12 1.5 times as long as broad (1:1.45). Epicnemium with a small central excavation. Petiolus considerably longer than tergum 1 (Fig. 211). Antennal segments 8-11 with two sets of tyloidea on the underside (Fig. 224) ... 55. beaumonti (v. Lith)
- Antennal segments 11 and 12 only slightly longer than broad (1:1.22). Epicnemium completely plane. Petiolus different. Tyloidea single. .... 5
- 5(4) Petiolus as in Fig. 206, as long as tergum 1. Punctuation dorsally on frons very dense, anteriorly almost coalescing. Antennae with tyloidea on segments 3-12 (Fig. 219) ..... 50. unicolor (v. d. Linden)
- Petiolus distinctly longer than tergum 1 (Fig. 208). Punctuation dorsally on frons comparatively sparse, interstices smooth and shining. Antennal segments with tyloidea only distinct on segments 3-9 (Fig. 220) ..... 51. littoralis (Bondroit)

50. MIMUMESA UNICOLOR (van der Linden, 1829)

Figs. 205, 206, 213, 216, 219.

Psen unicolor van der Linden, 1829:105.

Mimesa borealis Dahlbom, 1842:8.

Female: 7-9 mm. Frons very densely and rather deeply punctate. Especially in front of ocelli the punctures have a tendency to coalesce longitudinally. Behind the ocelli the sculpture forms a very distinct transverse striation,

which gradually disappears towards the underside of the head. The lower part of the face including the clypeus is covered by a dense, silvery pubescence. Scutum shining, strongly and rather densely punctate. Mesopleuron laterally distinctly, although rather superficially, punctate. Large specimens have a weak striation here. Petiolus short, not longer than tergum 1 (Fig. 205). Pygidial area broad, with strong microsculpture and evenly punctate over the entire surface (Fig. 216), apically with dense, slightly golden pubescence.

Male: 6-8 mm. Sculpture as in female. Flagellum long and slender, with narrow linear tyloidea on segments 3-12 (Fig. 219).

Rather sporadic and rare in Denmark: LFM, SZ, NWZ, NEZ. - Sweden: few records from Sk., Sm., ÖL., Gtl. - Finland: northern distribution limit in Ks. - Soviet Karelia: Ib. - The species is widely distributed in Europe, Asia Minor, and southern Siberia.

The species seems to be associated with sandy localities, but more detailed information about its breeding biology is not available.

51. MIMUMESA LITTORALIS (Bondroit, 1934)

Figs. 207, 208, 220.

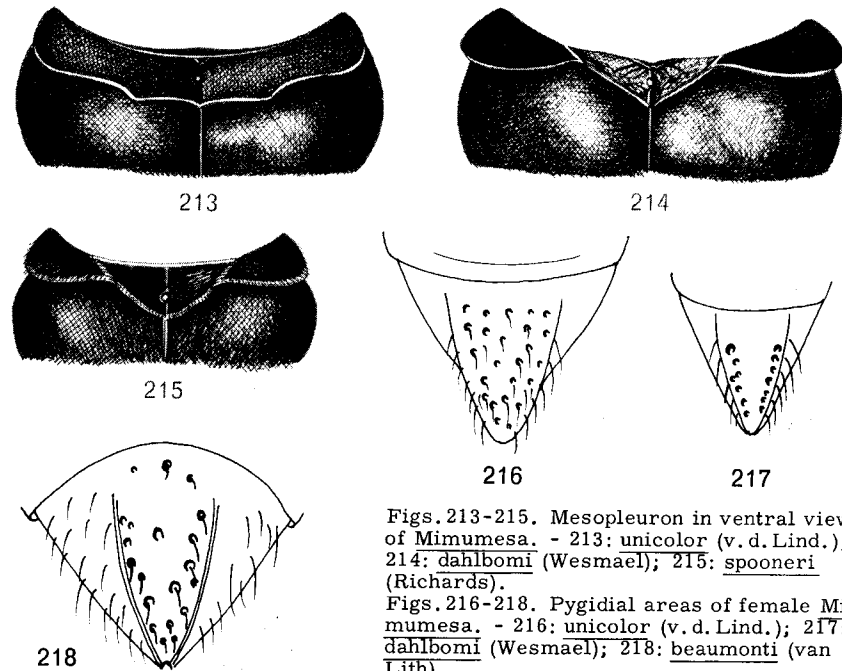

Figs. 213-215. Mesopleuron in ventral view of Mimumesa. - 213: unicolor (v. d. Lind.); 214: dahlbomi (Wesmael); 215: spooneri (Richards).  
Figs. 216-218. Pygidial areas of female Mimumesa. - 216: unicolor (v. d. Lind.); 217: dahlbomi (Wesmael); 218: beaumonti (van Lith).

Mimesa littoralis Bondroit, 1934:64.

Psen celtica Spooner, 1948:164.

Female: 6-8 mm. Very closely related to unicolor, from which it can only be separated by the characters mentioned in the key. Pygidial area relatively broader than in unicolor.

Male: 6-7 mm. Distinguishable from unicolor by the characters mentioned in the key. Tarsi pale. Antennae very slender, tyloidea as in Fig. 220.

Denmark: very rare. NEJ, the Skaw, one male (Schjødt leg). The species seems to maintain a stable population on the west coast of the peninsula Skallingen (WJ) (Lomholdt, 1973). - Sweden: Ö1.; the records from Sk. proved to be unicolor (van Lith, 1949). - Finland: sporadic in N, Ka, St, Sa, Om, and ObS. - Soviet Karelia: Ib. - The species is widely distributed in the Palaearctic region. From England recorded from the southern coast. Probably a white dune, or at least a littoral species in western Europe. Also recorded from the Netherlands and Germany. In Asia the species is distributed in Mongolia, Manchuria, and Japan.

Spooner (1948) states that the species breeds in sandy localities near the coast, in localities similar to those where Pompilus plumbeus Fabr. (Pompilidae) is found, i. e. in the white dunes. It is probable that the nests are constructed in decayed, hollow, partly exposed stems of marram-grass (Ammophila arenaria).

52. MIMUMESA ATRATINA (F. Morawitz, 1891)

Figs. 209, 210, 221.

Mimesa atratina F. Morawitz, 1891:206.

Mimesa belgicus Bondroit, 1933:34.

Female: 8-11 mm. Largest species of the genus. Punctuation of frons fairly dense, posteriorly forming weak transverse striation. Antennae long and slender, segment 3 more than three times as long as broad at distal end. Clypeus with dense silvery pubescence, anterior border not reflexed. Epicnemium anteriorly delimited by a strongly projecting carina (as in dahlbomi). Petiolus longer than tergum 1 (Fig. 209). Pygidial area broad, with regular punctuation and distinct microsculpture.

Male: 7-9 mm. As female, but of more slender build. Antennae with distinct tyloidea on segments 7-11 only. These are oval and rather shiny on segments 9-11, but narrow, almost linear on segments 7 and 8 (Fig. 221). Petiolus very long (Fig. 210), dorsally with a sharp longitudinal keel.

A rather local species in Sweden: Sk., Sm., Boh., Gtl., Og., Sdm., and

Gstr., and in Finland: Al (common); northernmost records from Om, Sb, and Kb. - Soviet Karelia: Ib. - The species is rather common in Central and South Europe. It also occurs in Japan. It may be found in southern Siberia.

Nest in dry, decayed wood, often in abandoned insect burrows. The diet of the larvae consists of small cicadas (Issidae).

53. MIMUMESA SPOONERI (Richards, 1948)

Figs. 215, 222.

Mimesa spooneri Richards, 1948:871.

Female: 7-9 mm. Closely related to unicolor, from which the species is, however, easily distinguishable by the deep cavity in the middle of the epicnemium (Fig. 215). The punctuation of frons is sparser, the interstices shining. The punctuation behind the ocelli finer and considerably sparser, never forming transverse striation. The silvery pubescence on lower part of frons so sparse that the underlying punctuation is distinctly seen. The radial carinae dorsally on propodeum strong, interstices smooth as a mirror (as in dahlbomi). Petiolus in lateral view slightly longer than tergum 1. Pygidial

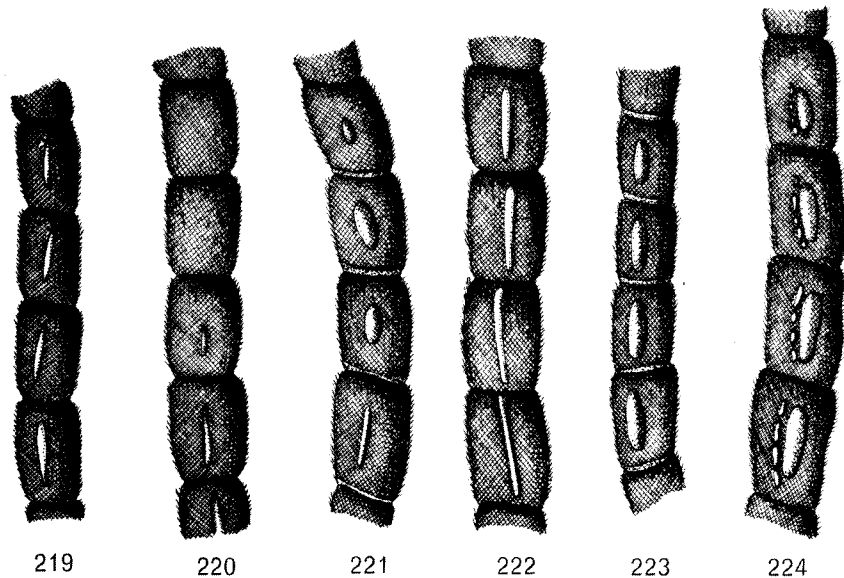

Figs. 219-224. Antennal segments 8-11 in ventral view of male Mimumesa. - 219: unicolor (v. d. Lind.); 220: littoralis (Bondroit); 221: atratina (F. Morawitz); 222: spooneri (Richards); 223: dahlbomi (Wesmael); 224: beaumonti (van Lith).

area broad, evenly and rather densely punctate, with strong microsculpture.

Male: 6-8 mm. As female, but punctuation of head and the silvery pubescence denser. Flagellar segments with strongly projecting, almost linear, tyloidea, which on segments 3-10 are as long as the segments, but on 11th and 12th are gradually reduced (Fig. 222). The distance between the lateral ocelli almost as great as the distance from one of these to the eyes. All tarsi dark.

Very rare in Denmark and Fennoscandia. Denmark: F, Enebærødde, 1 ♂ (Lomholdt, 1973). - Finland: a few records from N, Kb, and Om. - Sporadic occurrence in Central Europe, but relatively widespread in England.

The species breeds in sandy localities.

54. MIMUMESA DAHLBOMI (Wesmael, 1852)

Figs. 204, 212, 214, 217, 223.

Mimesa dahlbomi Wesmael, 1852:271.

Female: 7-9 mm. Head very broad. The area below the transverse carina in front of the antennal sockets shining, weakly punctate like clypeus. Silvery pubescence very sparse. Clypeus strongly convex, anterior border weakly reflexed, with an obtuse central emargination. Frons in front of ocelli with very dense, irregular punctuation, whereby the area gets a rugoso-striate appearance. Vertex with fine transverse lines. Scutum evenly and strongly punctate, with very weak microsculpture. Mesopleuron shining, punctuation laterally very fine, but somewhat irregular. Epicnemium as in Fig. 214. Pygidial area narrow, shining, with a row of coarse punctures along the lateral edges (Fig. 217).

Male: 6-8 mm. Sculpture as described in female. Silvery pubescence on lower part of face rather dense, although it does not cover the punctuation beneath. The emargination in the anterior border of clypeus considerably shallower than in female. Antennae long and slender. Tyloidea single, broad and distinct in antennal segments 6-11 (Fig. 223).

This species seems to be the most common and widespread species of Mimumesa in Denmark and Fennoscandia. The northern boundary for its distribution apparently goes through HOi in Norway, Jmt. in Sweden and ObN and Ks in Finland. - From Soviet Karelia the species is known from Ib and Ks. - Common in most parts of Europe.

The nests are constructed in decayed wood, e. g. tree stumps, dead branches, fencing posts and the like, perhaps associated with abandoned burrow systems of other insects. As prey are used small cicadas, e. g. Delphacodes fairemarei

Perr., Deltocephalus flori Fieb., and D. abdominalis Fabr. (Delphacidae), of which up to 38 specimens are the diet of the larvae.

55. MIMUMESA BEAUMONTI (van Lith, 1949)

Figs. 211, 218, 224.

Psen beaumonti van Lith, 1949:140.

Closely related to dahlbomi, but the epicnemium lacks the delimiting carina anteriorly.

Female: 7-9 mm. Silvery pubescence on lower part of face very dense, almost covering the underlying sculpture. Clypeus less strongly convex, anterior border not reflexed. Punctuation in pygidial area somewhat irregular, covering entire surface of apical half (Fig. 218).

Male: 6-8 mm. Silvery pubescence in lower part of face slightly denser than in female. Tyloidea double, one broad and flattened as in dahlbomi, the other narrow, often interrupted in several places, considerably weaker (Fig. 224). Antennae distinctly longer than in dahlbomi, middle segments almost twice as long as broad distally. Petiolus considerably longer than tergum 1 (Fig. 211).

Denmark: NEZ, Strandmøllen, 2 ♂. - In Sweden recorded from Ög., Sdm. and Gstr., and in Finland from Ab, N, Ta, and Kb. - Very local occurrence in Europe.

## Genus *Psenulus* Kohl

Psenulus Kohl, 1896:254.

Type-species: Psen fuscipennis Dahlbom, 1843.

Medium-sized black, robust species (Fig. 225), which in habitus may somewhat resemble Mimumesa. Antennae short and strong, inserted high up on frons on either side of a strongly elevated, more or less rhomboid area (Figs. 226-228). Anterior to this runs a sharp transverse keel. Head in anterior view only slightly wider than high. Clypeus weakly convex, its anterior margin with two small teeth. Lower part of face with silvery pubescence. Thorax short, very much broader than head. Pronotum dorsally with a sharp transverse carina. Scutellum with a strongly pitted transverse furrow anteriorly. Propodeum coarsely sculptured without distinctly delimited area cordiformis. Petiolus short. Abdomen short and broad, shining, smooth with sparse, fine punctuation. Legs short and strong. Tarsus 1 without spines. Tibia 2 with a single apical spur. Radial cell of forewings large,

triangular. Three cubital cells. First and second discoidal transverse vein join second and third cubital cells respectively. Female with rather indistinctly delimited pygidial area. Antennae of males (Figs. 233, 234) long, slightly moniliform.

A cosmopolitan genus comprising about 100 species, of which 7 occur in Europe.

The nests are constructed in old timber and similar places. The prey consists of Homoptera Sternorrhyncha.

Key to species of Psenulus

Females

- 1 Occipital carina behind ocelli double-arcuate (Fig. 229). Posterior part of scutum with strong, posteriorly converging, longitudinal rugae. Posterior area of propodeum coarsely and irregularly reticulate-rugose. Frons with strong longitudinal rugae ..... 57. fuscipennis (Dahlbom)
- Occipital carina not double-arcuate. Posterior part of scutum with at most weak longitudinal rugae. Propodeum, at least above, with regular striation. Frons with at most indicated rugae ..... 2
- 2(1) Sterna 4 and 5 along posterior margin with a fringe of long, stiff, whitish or yellow-brown bristles. Sternum 2 basally with parabola-shaped, weakly elevated convexity, inside which the sternum is weakly depressed. Anterior border of clypeus with strong U-shaped emargination (Fig. 227) ..... 58. pallipes (Panzer)
- Sterna 4 and 5 without hair fringe. Sternum 2 at most with a quite weakly indicated raised convexity. Anterior border of clypeus weakly emarginate ..... 3
- 3(2) Clypeus shining smooth, only posteriorly with distinct punctation; silvery pubescence absent. Flagellar segment 2 almost twice as long as third. Each of the lateral margins in the strongly raised area between base of antennae continuing into a transverse-running carina (Fig. 226). Punctation of head very fine and sparse ..... 56. concolor (Dahlbom)
- Clypeus dull, evenly and densely punctate with thick silvery pubescence. Flagellar segment 2 slightly lon-

ger than third. Lateral margins of the strongly raised area between base of antennae anteriorly fused into a single carina (Fig. 228). Head rather strongly punctate ..... 59. schencki (Tournier)

Males

- 1 Frons completely even, without rugae. Punctation very fine and sparse. The part of the radial vein situated between the second and third cubital transverse veins much longer than second cubital transverse vein (Fig. 231). Tyloidea oval ..... 56. concolor (Dahlbom)
- Frons, especially above, rugoso-punctate, sometimes coalescing into striae. The part of the radial vein situated between second and third cubital transverse veins equal to or shorter than second cubital transverse vein (Fig. 232). Tyloidea linear or absent ..... 2
- 2(1) Tyloidea very sharply delimited, the proximal ones more than half the length of the segments (Fig. 234). Flagellum ventrally only slightly paler than dorsally. Mesopleuron above strongly punctate, interspersed with rugae ..... 57. fuscipennis (Dahlbom)

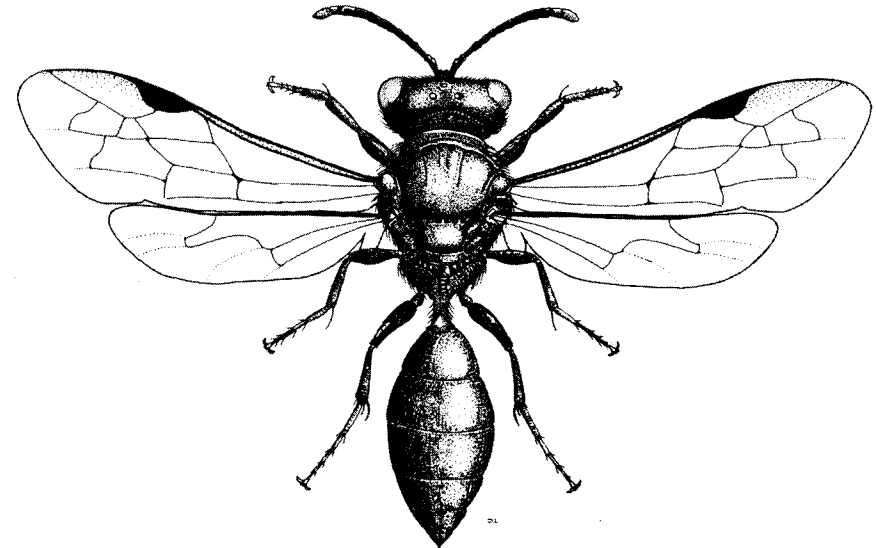

Fig. 225. Female of Psenulus concolor (Dahlbom). Length: 6-8 mm.

- Tyloidea vestigial or absent. Flagellum ventrally light brown or yellow-brown. Mesopleuron smooth and shining, only very rarely with indications of rugae, with sparse and rather fine sculpture ..... 3
- 3(2) Sternum 2 with a, sometimes weak, parabola-shaped elevated convexity. Anterior border of clypeus with a deep semi-circular emargination. Flagellum without tyloidea ..... 58. pallipes (Panzer)
- Sternum 2 quite smooth, without pad. Anterior border of clypeus with a shallow, arcuate emargination. Flagellar segments 4-11 with quite narrow tyloidea (Fig. 233) ..... 59. schencki (Tournier)

56. PSENULUS CONCOLOR (Dahlbom, 1843)

Figs. 225, 226, 231.

Psen concolor Dahlbom, 1843:429.

Female: 6-8 mm. Head smooth, shining, very finely and sparsely punctate, in anterior view as Fig. 226. Anterior part of scutum with four deep longitudinal furrows, finely punctate. Posterior part weakly longitudinally striate. Propodeum dorsally surrounded by a broad, strongly pitted furrow, otherwise finely, irregularly striate. Mesopleuron shining, finely punctate, with indications of rugae. Pygidial area indistinct. Sternum 2 without parabola-shaped raised area. Sterna 4 and 5 without bristle-fringe.

Male: 6-7 mm. Punctuation on head and thorax as in female. Propodeum very strongly, irregularly reticulate-rugose. Trochanter 1 long and narrow. Tibiae and tarsus 1 yellow-brown. Antennae long, not thickened apically. Flagellar segments ventrally yellow-brown with short and broad tyloidea.

Not common in Denmark and Fennoscandia, but sometimes occurring locally in large numbers. Denmark: SJ, EJ and NEZ. - Sweden: sparse in the southern parts, the most northern records from Upl. and Gstr. - Norway: a single specimen from AK, Tøien. - Finland: rather common on Al, several localities; a single specimen from N, Helsingfors. The species is not found in Soviet Karelia. - Widespread through North and Central Europe, southern Siberia to Japan.

Hollow or pith-filled plant stems are extensively used for nesting, e. g. Phragmites, Sambucus and Rubus. Also a few records from galls of Lipara lucens (Dipt., Chloropidae). In addition, found nesting in eaves of thatched roofs and in old building timber. The number of cells varies considerably,

but normally about five are made in each stem. The length of the cell varies from 7 to 11 mm, while the inside diameter is given as 2.5 - 4.2 mm. The cell partitions are made of fine plant material, mixed with saliva. Prey consists of nymphs of Psyllidae, which in a number varying from 14 to 24 constitute the provision of the larva. The egg is attached to one of the midmost psyllids. As hymenopterous parasitoids are stated Perithous mediator Grav. (Pimplinae), Cratocryptus anatorius Grav. (Cryptinae) and Eurytoma nodularis Boh. (Chalcidoidea).

57. PSENULUS FUSCIPENNIS (Dahlbom, 1843)

Figs. 229, 230, 234.

Psen fuscipennis Dahlbom, 1843:5.

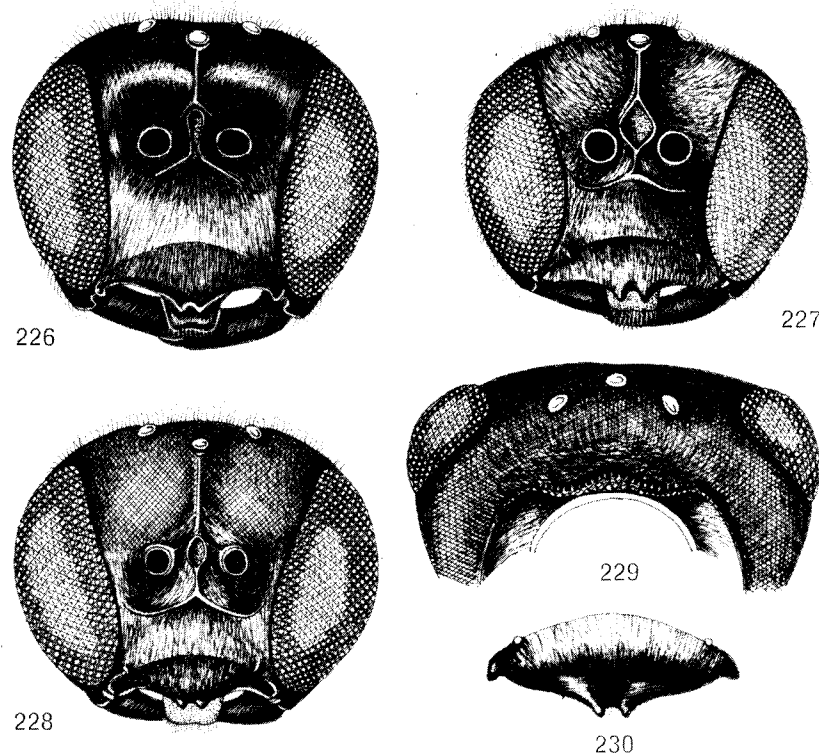

Figs. 226-228. Heads in frontal view of female Psenulus. - 226: concolor (Dahlbom); 227: pallipes (Panzer); 228: schencki (Tournier). Fig. 229. Head in posterior view of Psenulus fuscipennis (Dahlbom). Fig. 230. Clypeus of female Psenulus fuscipennis (Dahlbom).

Female: 8-10 mm. Head with exception of clypeus and lower part of face with strong striae, interspersed with extremely fine punctures. Clypeus anteriorly shining with two obtuse teeth (Fig. 230). Face, especially the lower part, with dense silvery pubescence. The elevated area between the antennal sockets well-developed. Antennae black with a weak brownish tinge ventrally at the tip. Occipital carina slightly depressed on each side (Fig. 229), hereby forming the typical double-arcuate course. Scutum with fairly dense and strong punctures, which coalesce laterally into very weak grooves, posteriorly with strong longitudinal striae. Mesopleuron, especially laterally, rugose, with distinct microsculpture. Propodeum laterally somewhat irregularly striate. Posterior face coarsely reticulate-rugose.

Male: 7-9 mm. Clypeus evenly and uniformly punctate. Head otherwise and thorax sculptured as in female. Lateral faces of propodeum coarsely and irregularly striate, posterior face very coarsely and deeply rugose. Tyloidea well-developed (Fig. 234).

A typical continental species. In Fennoscandia rather common in the central parts of Sweden and Finland, towards the north to Gstr. and Kb. - Norway: a single specimen from HEs, Hoff, - The species is absent from Denmark. - The distribution area covers large parts of Central Europe and extends eastwards to the Pacific Ocean. A subspecies in Japan.

The species is stated to nest partly in dry stems of Phragmites, partly in abandoned insect tunnels in decaying wood. Each nest may contain up to 20 cells. Each cell is about 20 mm long and is provisioned with from 16 to 47 Cinara sp. (Aphididae). The larva was described by Grandi, 1934 and Iida, 1969. - As hymenopterous parasitoids are given Perithous septemcinctus Thunb. (Ichneumonidae) and Melittobia acasta Walt. (Eulophidae).

#### 58. PSENULUS PALLIPES (Panzer, 1798)

Figs. 227, 232.

Sphex pallipes Panzer, 1798: H. 52, T. 22.

Trypoxylon atratum Fabricius, 1804:182.

Psen haemorrhoidalis A. Costa, 1871:102.

Psen chevrieri Tournier, 1889:126.

Psenulus rubicola Harttig, 1931:210.

Psenulus puncticeps Gussakovski, 1933:6.

Psenulus lubricus Gussakovski, 1934:80.

Psenulus brevitarsis Merisuo, 1937:84.

Female: 6-8 mm, male: 5-7 mm. Punctuation of head very variable. In large,

robust specimens the punctuation often coalesces into rugae, notably behind the ocelli. In smaller specimens the punctuation of the head is often considerably finer and sparser. The raised area between the antennal sockets varies from being approximately diamond-shaped (Fig. 227) to more or less elongate rhomboid, almost as in concolor. The lateral borders are, however, always fused anteriorly into a single carina. Clypeus densely and evenly punctate, with uniform, silvery pubescence. Anterior border with a strong U-shaped emargination, on each side delimited by a truncate tooth (Fig. 227). This character is most distinct in the females. Antennae short, strong in females, elongate, weakly moniliform and occasionally with vestigial tyloidea in the males. Sternum 1 with distinct parabola-shaped, raised area. Sterna 4 and 5 in females with a strong fringe of bristles. Pygidial area flat, broadly triangular, weakly excavated apically. Last tergum in males often with extensive red-brown colour pattern basally (haemorrhoidalis A. Costa).

The species is widely distributed in Fennoscandia and Denmark. - Sweden: northern distribution limit runs through Vrm., Dlr. and Gstr. - Not recorded from Norway. - Finland: northernmost findings from Kb. - Holarctic species, with a subspecies in North America. Distributed through

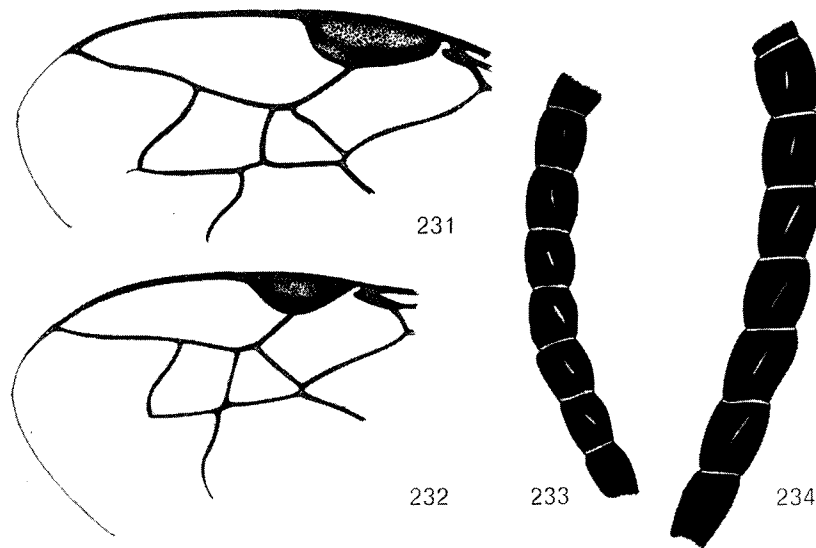

Figs. 231-232. Distal part of forewings of male Psenulus. - 231: concolor (Dahlbom); 232: pallipes (Panzer).  
Figs. 233-234. Antennae in ventral view of male Psenulus. - 233: schencki (Tournier); 234: fuscipennis (Dahlbom).



the more temperate areas of the Palaearctic region, eastwards to China, Japan and Korea.

As nesting place, hollow plant stalks are preferred, e.g. Phragmites, Ribes, Rubus and Rosa, or abandoned insect tunnels with suitable diameter in old timber. The species may be found nesting in great numbers in eaves of thatched roofs. The cell partitions consist of available material, e.g. fine sawdust, which is glued together with a sticky secretion from the salivary glands. The prey is aphids of the genera Macrosiphum, Amphorophora, Chromaphis, Myzodes, Doralis and Aphis (Aphididae), of which about 30 specimens represent the provision for each larva. The finished nest may contain 6-8 cells. As hymenopterous parasitoids can be mentioned Omalus auratus L., O. bidens Forst. (Chrysididae) and Perithous mediator Fabr., and P. divinator Rossi (Ichneumonidae).

Note. The great morphological variation in this species has given rise to a considerable number of synonyms (see de Beaumont, 1937). The taxonomical status of some of these does, however, need careful examination, and especially Tsuneki (1959) and Merisuo (1937a, 1937b, 1938, 1967) express a different point of view. For discussion of nomenclature and systematics, see also van Lith, 1972.

59. PSENYLUS SCHENCKI (Tournier, 1889)

Figs. 228, 233.

Psen schencki Tournier, 1889:109.

Female: 7-8 mm. Frons quite even, shining, punctation sparse, slightly stronger than on scutum. Antennae short and strong, pale ventrally. Clypeus anteriorly with a slight emargination between the two small teeth (Fig. 228). Silvery pubescence dense anteriorly on head. Punctation on scutum somewhat irregularly distributed, densest round the rather weak longitudinal furrows on anterior half. Propodeum dorsally weakly and indistinctly striate, lateral faces with indications of rugae. Mesopleuron shining, with only very fine, sparse punctures. Pygidial area narrow, posteriorly with sharp lateral margins. Only trochanter 1 plane ventrally. Tibia 2 on the outer side with a very weak longitudinal furrow. Legs black with pale tarsi. Tibia 1 pale on the inner side.

Male: 6-7 mm. Frons anteriorly striate with interstitial rows of punctures. Clypeus with shallow emargination between the two small teeth. Antennae long, moniliform. Tyloidea short, on terminal segments visible only as very small elevations (Fig. 233). Thorax as in female. Propodeum with very coarse, strongly projecting rugae. Sternum 2 without raised convexity.

In Fennoscandia this species has a very restricted distribution in central Sweden including Ö1. - Norway: a single male from AK, Bygdeø. - The species might be found in SW Finland, especially Åland. - Distributed in Europe and North Africa.

The nests are constructed in decayed wood, fencing posts and the like, usually in abandoned insect burrows. Each nest contains 4-6 larval chambers; nests with up to 18 cells may however occur. The prey consists of leaf-hoppers (Psyllidae). As hymenopterous parasitoids are known Diomorus kollari Först. (Torymidae) and Chaenocryptus macilentus Grav. (Ichneumonidae).

## SUBFAMILY PHILANTHINAE

A well-defined subfamily comprising brightly-coloured, rather large species. It includes 6 tribes of which only Cercerini and Philanthini are represented in Europe. Inner orbits parallel or diverging ventrally, emarginate in Philanthus. Mandibles without ventral emargination, simply attenuate, inner margin often dentate. Maxillary palpus six-segmented, labial palpus with four segments. Shape of clypeus highly variable in females of Cerceris, only weakly three-lobed in Philanthus. Anterior margin of clypeus in males with a stiff fringe of dense bristles. Antennae filiform in Cercerini, often clavate in Philanthini, inserted well above epistomal suture. Pronotum without transverse carina in European species, slightly depressed below scutum. Mesopleuron without epicnemium, epicnemial suture weakly pitted or vestigial. Propodeum rounded, dorsally with a more or less distinct, triangular area with different sculpture. Abdominal segment 1 often nodiform, constricted posteriorly. European species with pygidial area in both sexes. Females with well-developed tarsal pecten. Tibia 2 with a single spur. First and second discoidal transverse veins join second and third cubital cells, respectively. Second cubital cell petiolate in most Cercerini.

The larvae are easily distinguished by several characters. Anal segment conically protuberant, either the supra-anal or the sub-anal lobe projecting, or the two lobes together forming a tubular projection. Body almost everywhere covered by small spinules. Opening between atrium and subatrium simple, unarmed. Head higher than wide, parietal bands absent. Antennal papillae present. Mandibles long and slender, more than twice as long as maximum width. Galea much smaller than maxillary palpus, sometimes vestigial. Spinneret paired.

The subfamily comprises 11 genera that are mainly represented in the tropics. Only two genera in Europe. Nests in the soil.

## Genus *Cerceris* Latreille

*Cerceris* Latreille, 1802:367.

Type-species: *Philanthus ornatus* Fabricius, 1790. (= *Sphex rybyensis* Linné, 1771).

Head large, in front view circular or wider than high. Inner orbits parallel or diverging downwards. Mandibles robust, simply attenuate, but often with one or two triangular teeth on the inside. Antennae filiform, inserted high up on frons, well above epistomal suture. Between these a strong, sharp, longitudinal keel. Clypeus in females usually with very characteristic specific structure, as the central area may be strongly elevated and projecting, sometimes with a deep emargination apically. Males often with a strongly developed fringe of stiff bristles on either side along anterior border of clypeus. Face with yellow pattern, most strongly developed in male. Humeral tubercle broad and flat, distance to tegulae very short. Mesopleuron without epicnemium or epicnemial carina. Thorax with coarse sculpture, consisting of deep, often coalescing pit-like punctures. Propodeum with dorsal, triangular, often strongly striate area. Abdomen very characteristically shaped, with strong constrictions between segments. First segment usually comparatively small, distinctly delimited from the rest, but not forming a proper petiolus in European species. Abdomen and thorax with yellow pattern of very variable extent; can only be used with considerable caution as diagnostic character. Last tergum in both sexes with well developed pygidial area. Foretarsus with pecten, which however is much more strongly developed in females. Tibia 2 with only a single apical spur. Femur 3 very characteristically shaped, especially in females, since apically they carry a plane, dull area, which is partly formed by the posterior area of a broad, downward directed, spiny prolongation, partly by the truncate apex of femur. Forewings with three cubital cells, of which the second is petiolate. First and second discoidal transverse veins join second and third cubital cells, respectively. Apex of radial cell rounded. Stigma narrow.

The genus comprises more than 500 species and has a cosmopolitan distribution, but most species are found in arid tropical and subtropical areas. From Europe about 40 species are known.

The species may be found nesting in dry, usually sandy ground. Prey consists of Apidae (Hymenoptera), Curculionidae, Chrysomelidae or Buprestidae (Coleoptera).

## Key to species of *Cerceris*

### Females

- 1 Clypeus, except narrow strip along anterior border, yellow, anterior part concave, without raised area. Third antennal segment only slightly longer than fourth. Sternum 2 basally with distinctly-margined elevated area; tergum 4 without yellow pattern ..... 60. *rybyensis* (Linné)
- Clypeus with large black spots, central area strongly projecting. Third antennal segment much longer than fourth. Sternum 2 without elevated area, tergum 4 with yellow pattern ..... 2
- 2(1) Clypeus with thin, black, shelf-like elevation. Head in front view very broad, inner orbits strongly diverging ventrally (Fig. 236) ..... 61. *arenaria* (Linné)
- Central part of clypeus very strongly elevated, convex,

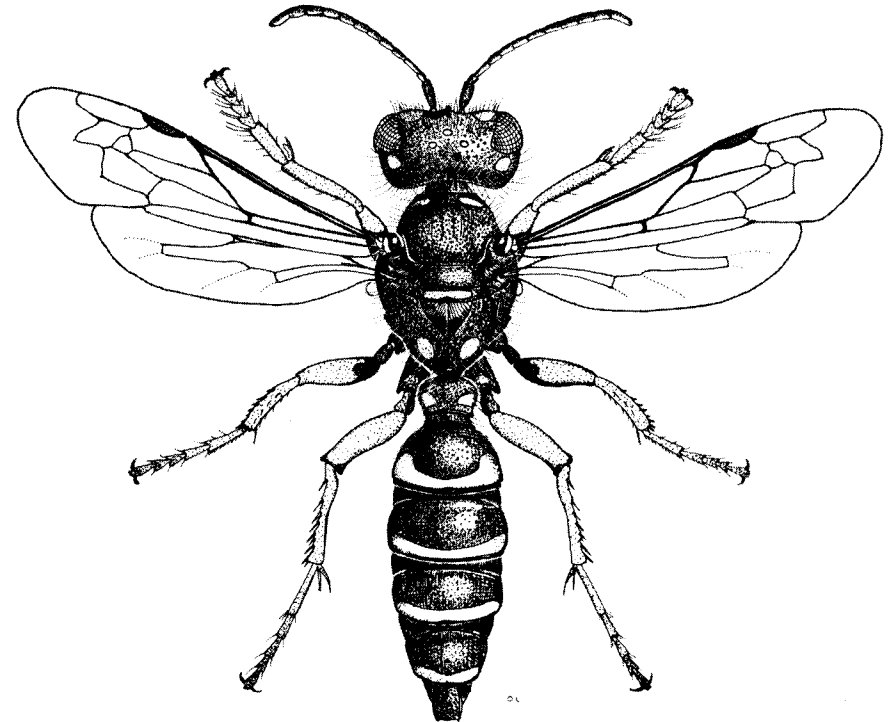

Fig. 235. Female of *Cerceris arenaria* (L.). Length: 10-16 mm.

- anteriorly more or less emarginate. Inner orbits parallel or weakly diverging ..... 3
- 3(2) Clypeus very characteristically shaped, central part very large, projecting almost like a nose (Fig. 239). Tergum 1 with large, yellow lateral spots.. 64. ruficornis (Fabricius)
- Clypeus different. Tergum 1 without yellow spots 4
- 4(3) Whole anterior border of elevated area on clypeus deeply semi-circularly emarginate or with an obtuse-angled incision (Fig. 238). Interstices between punctures of scutum shiny. Abdomen rather coarsely punctate. Triangular area dorsally on propodeum usually strongly striate with shiny interstices. Femora 2 and 3 red-yellow. Metanotum usually with yellow pattern ..... 63. quinquefasciata (Rossi)
- If anterior border of the raised part of clypeus is emarginate, this forms either a very shallow arch or a small U-shaped figure, whose maximum width does not exceed half the breadth of the entire anterior margin (Fig. 237). Interstices between punctures of scutum with distinct, reticulate micro-sculpture, dull. Abdomen rather finely punctate. Triangular area dorsally on propodeum with irregular striation; dull interstices. All femora dark. Metanotum black ..... 63. quadrifasciata (Panzer)

Males

- 1 Sternum 2 basally with a distinctly margined, elevated area. Terga 4 and 5 without yellow transverse band, at most with lateral spots. Whole body very coarsely and densely punctate. Interstices smaller than diameter of punctures ..... 60. rybyensis (Linné)
- Sternum 2 without elevated area. Terga 4 and 5 with yellow transverse bands ..... 2
- 2(1) Pubescence on posterior border of sternum 6 forming a distinct bunch of hairs adpressed to sternum 7 on either side. Fringe of hairs along anterior border of clypeus strongly developed, so dense that the anterior border proper is not visible from above ..... 3

- Pubescence on sternum 6 without bunch of hairs. Fringe of bristles along anterior border of clypeus transparent ..... 4

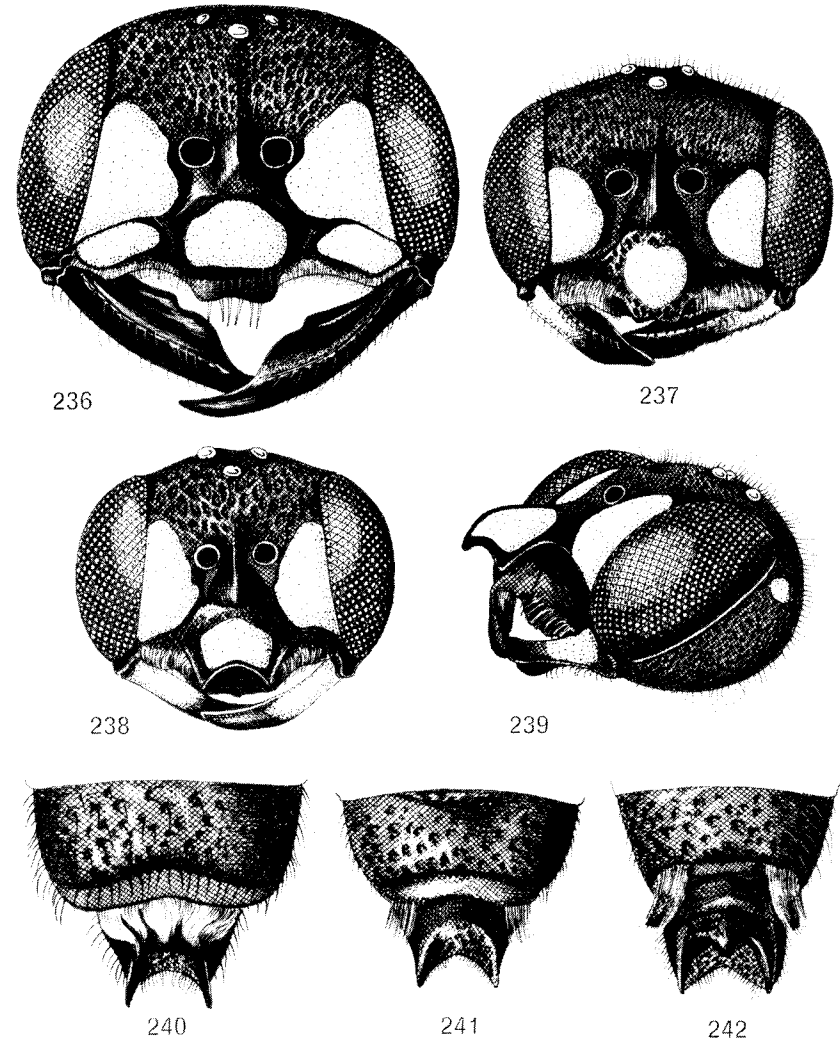

Figs. 236-238. Heads in frontal view of female Cerceris. - 236: arenaria (L.); 237: quadrifasciata (Panzer); 238: quinquefasciata (Rossi). Fig. 239. Head of female Cerceris ruficornis (Fabr.) in antero-lateral view. Figs. 240-242. Apex of abdomen in ventral view of male Cerceris. - 240: arenaria (L.); 241: quinquefasciata (Rossi); 242: ruficornis (Fabr.).

- 3(2) Punctuation on tergum 2 irregular but dense. Size of punctures very varied, from very fine to rather coarse. Brushes of hairs on tergum 6 directed obliquely outward, very dense (Fig. 242) ..... 64. ruficornis (Fabricius)
- Punctuation on tergum 2 regular, consisting only of uniform-sized punctures. Brush of hairs on tergum 6 directed straight back (Fig. 241)..... 63. quinquefasciata (Rossi)
- 4(2) Punctuation on terga 3 and 4 very coarse, interstices smaller than diameter of punctures ..... 61. arenaria (Linné)
- Punctuation on terga 3 and 4 finer, interstices larger than or equal to diameter of punctures ... 62. quadrifasciata (Panzer)

60. CERCERIS RYBYENSES (Linné, 1771)

Sphex rybyensis Linné, 1771:8.

Female: 8-14 mm. Lower part of face and clypeus, except anterior border proper, yellow. Anterior part of clypeus slightly concave, anterior border weakly arcuately emarginate. Frons in front of ocelli longitudinally coarsely rugoso-punctate. Interstices with fine striation. Mandibles yellow with black apex, ventrally with conspicuously projecting, arcuate lamella. Pubescence on clypeus sparse, adpressed and silvery; on frons long and erect, yellow-white. Flagellum black, ventrally brown-yellow. Pronotum with larger or smaller yellow lateral spots (usually absent in Fennoscandian specimens). Scutum very densely and coarsely punctate. Interstices smaller than diameter of punctures. Triangular area on propodeum usually shiny and smooth in the middle, laterally with short, strong striae. Tergum 1 usually, tergum 4 always, without yellow pattern in specimens from Denmark and Fennoscandia. Tergum 3 almost entirely yellow, anteriorly with triangular black spot. Individuals from Fennoscandia often lack yellow pattern on terga 3 and 5. In these specimens the yellow marking on tergum 3 may be divided into two lateral spots. Specimens from Central and South Europe often have very extensive yellow markings on terga 4 and 5 and sternum 3. Tibiae yellow or red-yellow. Femora 1 and 2 black with yellow apex, femur 3 mainly dark in Fennoscandian specimens, red-yellow with dark base in many Danish specimens. The yellow and red-yellow pattern on legs considerably more extensive in specimens from Central and South Europe.

Male: 7-10 mm. Front of head with widely distributed white-yellow or slightly greenish yellow pattern. Hair fringe, covering base of mandibles, light brown and transparent. Mandibles black, sometimes with faint yellow

basal spot, with a weak arcuate lamella ventrally. Antennae black, proximal flagellar segments yellow-brown ventrally. Thorax without yellow pattern. In Danish, Central and South European specimens metanotum may carry a faint yellow transverse spot. Abdomen very coarsely and densely punctate. Tergum 3 always with very extensive yellow pattern. Often a triangular black area anteriorly. In addition, often yellow transverse bands on terga 2 and 6. Very seldom small lateral spots on terga 4 and 5. Variation in extent of yellow pattern appears to be mainly geographically (climatically) conditioned, since specimens from Fennoscandia, on average, are considerably darker than specimens from Denmark and the rest of Europe.

Common and widely distributed in Fennoscandia and Denmark. - Denmark: not found in western and northern Jutland. - Sweden: found in most districts up to Dlr. and Gstr. - Norway: distributed in the south-eastern districts, towards the north to On. Valdres. - Finland: occurring in most of the southern districts. - Soviet Karelia: Ib and Kr. - The species is distributed all over the western Palaearctic region, eastwards to Kazakhstan. In Japan there is a separate sub-species, C. rybyensis japonica Ashmead, (Tsuneki, 1961).

A common species which, like e.g. C. arenaria and C. quadrifasciata, may often be found nesting in large aggregations. Prey usually consists of smaller species of Halictus and Andrena, but species of Halictoides and Panurgus (Hymenoptera, Apidae) are also used. These species often nest in the same type of locality as species of Cerceris. Rybyensis only hunts bees returning to their nest with pollen (Hamm & Richards, 1930). After having paralyzed the prey by a few stings between head and thorax or between pro- and mesothorax the neck region is squeezed vigorously with the mandibles (malaxation). Thereupon the prey is unable to coordinate movements of legs and wings, and it will die within about two days. It is probable that Cerceris, like Philanthus, licks nectar or possibly hemolymph during malaxation.

The main entrance is 10-15 cm long, first descending, later running horizontally. It terminates with a cell, but issuing from the horizontal tunnel up to seven additional cells are constructed. The number of prey in each cell varies from 5-8, dependent on size. Usually only a single species is deposited in each nest. Orientation flight of rybyensis is very similar to that described for Philanthus.

As parasitoids are mainly found Hedychrum nobile Scop. and H. gerstaeckeri Chev. (Hymenoptera, Chrysididae), of which especially the former may occur in great numbers. Species of Metopia and Pterella (Diptera, Sarcophagidae) are known as cleptoparasites.

Note. Specimens from Gotland deviate from the remaining Fennoscandian populations by the following characters: colour pattern on head and abdomen ivory-white or creamy, never yellowish. Female: Tegulae seldom with yellow spot. Only terga 2 and 3 with pattern, spots on tergum 2 very small or absent, on tergum 3 usually separated. Tibia 3 brown. Male: Area round anterior tentorial pit black. Spots on tergum 2 very small, sometimes absent.

61. CERCERIS ARENARIA (Linné, 1758)

Figs. 235, 236, 240.

Sphex arenaria Linné, 1758:571.

Female: 10-16 mm. Head (Fig. 236) very broad ventrally, in front view approximately trapezoid. Inner orbits distinctly diverging ventrally. Clypeus with a thin, shelf-like, slightly reflexed projection. Face ventrally with two yellow triangular spots. Clypeus usually with three yellow spots, one usually covering the central area, but may be very reduced, and two lateral ones. Mandibles often with a basal yellow spot. Just behind the eyes there are generally two yellow spots of variable size. Yellow pattern on head varies considerably. Specimens from South Europe may have the entire clypeus yellow except for a small triangular black spot round anterior tentorial pits. These specimens, in addition, often have small yellow spots just behind and in front of the keel between the antennal sockets, as well as between the ocelli and the very large yellow spots behind the eyes. In specimens from Fennoscandia the yellow markings on clypeus are often absent, and the triangular spots along inner orbits and the spots behind the eyes may be very reduced. Frons in front of ocelli coarsely rugoso-punctate, rugae with weak microsculpture. Pronotum with two larger or smaller yellow lateral spots, only seldom absent in Fennoscandian specimens, but may coalesce to form a transverse band in specimens from South Europe. Scutum dull with coarse, rather sparse punctation. Metanotum with yellow transverse spot, which is only seldom dissolved into two lateral spots. Triangular area on propodeum dull due to the strong microsculpture, with strong longitudinal carinae. Remaining part of propodeum very coarsely and densely pitted, usually with two large yellow lateral spots, although these are frequently absent in specimens from Fennoscandia. Terga 1 - 5 with yellow transverse bands along posterior border, although often intersected in middle on tergum 1. Sterna often with yellow markings. Legs red-yellow, femora proximally black in specimens from Denmark and South Scandinavia. Material from more northern localities usually with completely black femora and partly dark coloured tibiae.

Male: 9-15 mm. Face with very extensive yellow pattern, extending up along inner orbits beyond antennal sockets. Vertex usually with small yellow dot behind eyes in Danish specimens. Mandibles with more or less extensive yellow markings in middle, ventrally near apex with obtuse-angled projecting lamella. Anterior border of clypeus black, with three truncate teeth. Antennae black, scapus yellow ventrally, near apex with obtuse-angled dilatation, four proximal segments of flagellum and the most distal one brown-yellow ventrally. Pronotum in specimens from southern Scandinavia and Denmark may have two small yellow lateral spots. Metanotum with yellow transverse spot, which is, however, usually absent in individuals from Fennoscandia. There may be two yellow spots on propodeum, especially in robust specimens from Denmark, Central and South Europe. Abdomen very densely and coarsely punctate, almost pitted, with narrow yellow transverse bands on terga 2-6. Some very few Danish specimens have two yellow lateral spots on tergum 1. Sterna 2-4 generally with yellow marking. Sternum 6 with strong fringe of bristles along posterior border (Fig. 240). Coxa 3 usually yellow centrally. Front and midlegs yellow with base of femora black. Femur 3 yellow with brown-yellow to black apex.

The colour pattern shows, especially in the female, a very conspicuous variation, but also in small populations the extent of the yellow colour varies considerably. Small specimens are more extensively black than larger ones.

C. arenaria is the most common species of the genus occurring in Denmark and Fennoscandia. The northern distribution limit in Sweden runs through Dir. and Med. - Norway: northern occurrence in SFi and HEs. - Finland: distributed towards the north to Om, Sb and Kb. - Soviet Karelia: Ib and Kr. - The species is very widely distributed in the Palaearctic region, from the Atlantic and the North Sea in the west, to the Sahara in the south and the Pacific in the east.

This species may be very abundant locally, several hundred individuals may nest in a very restricted area. The nest is constructed as in rybyensis, but contains several cells on average. Prey consists of larger Curculionidae (Coleoptera) of the genera Brachyderes, Otiorrhynchus, Strophosomus, Tanymecus, Sitona, Hylobius, Pissodes and Curculio. Exceptionally other Coleoptera are used, e. g. Bromius obscurus L. (Chrysomelidae). In Russia the species has proved to be useful in the biological control of noxious Curculionidae in coniferous forests (Blagoveshchenskaia, 1970). It seems to be usual for each nest to contain only one species of prey. Dependent on size, each cell is provisioned with 5-12 specimens, usually 8. - Parasitoids are mainly Hedychrum nobile Scop. and H. aureicolle niemeläi Lins. (Hym.,

Chrysididae). Species of Metopia, Pterella, Miltogramma and Leucophora (Diptera) are recorded as cleptoparasites. Larva described by Iida, 1969.

Note. The authors Schletterer (1889), Shestakov (1922), Beaumont (1951), Tsuneki (1961) and Eck (1973) have divided the species into eight subspecies, of which four are stated to occur in North Europe (Eck, op. cit.) The geographical distribution of these, according to Eck, is as follows:  
C. a. arenaria L. Sweden: Vrm., Dlr., Upl., Sdm., Vg., Ög., Sm. (Kalmar) and Öl.

C. a. gotlandica Eck. Sweden: Gotland, Fårön.

C. a. erlandssoni Eck. Denmark; Sweden: Sk., Bl., Hall.

C. a. incognita Eck. Central Europe between the North Sea and Baltic coasts and the German "Mittelgebirge", Poland.

The definition of these taxa is, however, not very exact, being exclusively based on colour characters. As indicated above, the colour variation in this species is considerable, but continuous, so that we can speak about a pronounced cline in the distribution range. The population on Gotland is, however, comparatively well delimited and characterized by the sparse yellowish white pattern (see also C. rybyensis (L.)).

The Danish collection of C. a. erlandssoni contains a representation (16 females, 14 males) of the well-delimited population on SW Funen, Svanninge Bakker. These specimens do not agree very well with the remaining Danish material of erlandssoni, and in many features are similar to gotlandica.

In her paper Eck did not refer to subspecies the collection studied by her from Finland (18 females, 15 males). She only stated that "die finnischen Tiere längst nicht so scharf von C. a. arenaria abgrenzbar (sind) wie C. a. erlandssoni von der mitteleuropäischen Form".

62. CERCERIS QUADRIFASCIATA (Panzer, 1789)

Fig. 237.

Philanthus quadrifasciata Panzer, 1789: H. 64, T. 14.

Female: 9-12 mm. Head in front view as Fig. 237, inner orbits only slightly diverging ventrally. Raised part of clypeus with either arcuate or more or less strongly U-shaped emarginate anterior border. Emargination always narrower than half breadth of anterior border. Pattern on head yellow, delimited to central spot on clypeus and large spots along inner orbits. In Denmark specimens occur with larger or smaller lateral spots on clypeus. Only rarely do specimens occur in Denmark with yellow spots behind the eyes. Mandibles dark with a larger or smaller yellow proximal spot. Thorax and

propodeum normally entirely black, but specimens occur with two weak yellow lateral spots on pronotum. Punctuation on terga 3 and 4 rather weak. Interstices between punctures considerably greater than their diameter. Tergum 1 always without yellow pattern, terga 2-4 and often also 5 with narrow yellow transverse bands along posterior border. Femora mainly black with brownish apex. A faint yellowish streak may sometimes occur on femur 3. Tibia 1 and 2 mainly yellow, tibia 3 with a large brown spot on the outer side.

Male: 8-11 mm. Very similar to arenaria, from which it can be distinguished by the following characters. Head and thorax with very long pubescence. Anterior border of clypeus with three very weak, rounded teeth. Hair-fringe along anterior border very weak. Spots along inner orbits usually not fused with the triangular spot behind the epistomal suture. Thorax with at most two weak yellowish spots on pronotum. Terga 3 and 4 with distinctly finer and sparser punctuation. Hair-fringe on sternum 6 very weak and thin. Femora 1 and 2 black, femur 3 proximally yellow like its trochanter. Tibia 1 and 2 and tarsi yellow, tibia 3 with large brown spot on the outer side.

The species is widely distributed in Fennoscandia and Denmark, but does not seem to be as common as the preceding species. Its northern distribution limit in Sweden passes through Vb. and Nb. - Norway: occurs mainly in the southern coastal districts. - In Finland the species occurs towards the north in ObN. - Soviet Karelia: Ib and Kr. - Distributed all over Europe, through southern Siberia, Manchuria to the Pacific Ocean.

Like arenaria the species may be very abundant locally. Thus Abrahamson (in litt.) counted 5 - 600 specimens in a single colony. The locality was a fire break in Denmark: WJ, Klosterhede Plantage. Each nest contains about 4 cells and is provisioned with about 10 individuals of weevils of genera like Phyllobius, Polydrosus, Anthonomus or Otiorrhynchus (Coleoptera, Curculionidae). Where quadrifasciata is abundant, it may be useful in decimating the populations of noxious weevils.  
Hedychrum nobile Scop. and H. aureicolle niemeläi Lins. (Hym., Chrysididae) are known as parasitoids.

63. CERCERIS QUINQUEFASCIATA (Rossi, 1792)

Figs. 238, 241.

Crabro quinquefasciata Rossi, 1792:139.

Female: 7-11 mm. Head in front view as Fig. 238. Anterior border of raised part of clypeus deeply, semi-circularly emarginate throughout whole

width. A central spot on clypeus, and two large spots along inner orbits white-yellow. In addition, white-yellow markings proximally on mandibles, and a small dot behind the eyes. Lateral spots on clypeus rarely occur in Danish specimens, but are well-developed in specimens from Central and South Europe. Antennae black, red-yellow ventrally. On thorax, white-yellow are: two lateral spots on pronotum, a transverse band on metanotum and spots on tegulae. Thorax shining, smooth dorsally, without microsculpture. Triangular area on propodeum shiny, strongly and regularly striate. Abdomen with white-yellow lateral spots on terga 2 - 5, which may fuse into a narrow transverse band on terga 3-5. On first tergum there may be small lateral spots. Femora in the Fennoscandian and Danish material mainly black, femora 1 and 2 with yellow pattern distally, femur 3 red-yellow distally. Specimens with uniform red-yellow femur 3 may occur, especially in Denmark. Tibiae and tarsi darker or lighter red-yellow.

Male: 6-10 mm. Face with very extensive yellow markings. Large spots along inner orbits coalesced with the triangular spot above the epistomal suture. Anterior border of clypeus with either rounded lateral corners or with a very weak central tooth. Mandibles with very large yellow mark ventrally, and with black, projecting lamella near apex. Antennae ventrally brown-yellow. Danish specimens often have a very small yellow dot behind the eyes. Metanotum always with yellow transverse spot. Triangular area on pronotum shiny, with more or less distinct longitudinal rugae. Abdomen with white-yellow triangular spots on terga 2 - 5. These may be narrowly connected. Danish specimens may have small lateral spots on tergum 1, and tergum 6 may be marked with yellow. Sternum 6 with thin tuft of hairs on either side (Fig. 241). Femora 1 and 2 with large distal yellow mark, femur 3 usually tri-coloured: the proximal part yellow, followed by a larger or smaller black area, while the apex is red-brown or yellow-brown. Specimens with completely black femur 3 may occur. Coxa 3, trochanter 3 and trochanter 2 usually with yellow spots. Tibiae 1 and 2 with a lighter or darker brown streak on the outer side.

A southern species in Fennoscandia and Denmark. - Denmark: sparsely distributed in EJ, NEJ and NEZ. - Sweden: a few records from Sk., Sm. and ÖL. - Not found either in Norway or in Finland. - Soviet Karelia: Ib. - Widely distributed throughout the Palaearctic region. From Europe and North Africa to the Pacific Ocean.

The nest may contain up to 10 cells (Grandi, 1961), which are provisioned with smaller Curculionidae, e. g. of the genera Apion, Sitona, Micrelus (Ceuthorrhynchus p. p.), Tychius or Strophosomus, of which each cell may

contain up to 82 specimens. Usually there are about 50 prey specimens in each cell. Hamm and Richards (1930:113) mention that the species should also be able to use Meligethes (Coleoptera, Nitidulidae). In the fact that a single nest often contains several species (see also Adlerz, 1903 and Grandi, 1961), quinquefasciata deviates from the majority of Cerceris species. It is often gregarious. Larva described by Grandi, 1961.

64. CERCERIS RUFICORNIS (Fabricius, 1793)

Figs. 239, 242.

Philanthus ruficornis Fabricius, 1793:292.

Crabro cunicularia Schrank, 1802:234.

Philanthus trifidus Fabricius, 1804:305.

Cerceris labiata auctt.

Female: 10-13 mm. Central part of clypeus quadrate or trapezoid, very strongly elevated, convex, forming angle of about 60° with remaining part of clypeus, with large white-yellow spot. Anterior border of elevated area evenly emarginate or double arcuate-emarginate, with rounded tooth in middle (Fig. 239). Head with additional white-yellow or faintly green-yellow pattern in the shape of two large spots along inner orbits and usually a pair of spots behind eyes. Sometimes two lateral spots on clypeus; these spots mainly found in specimens from Central and South Europe, but may also occur in occasional specimens from Denmark (SJ). Basal half of mandibles with extensive yellow mark. Pronotum with yellow lateral spots, tegulae and metanotum also with yellow markings. Triangular area on propodeum shiny, strongly longitudinally striate. Tiny yellow lateral spots on propodeum may occur in individuals from Central and South Europe. Abdomen with yellow spots on terga 1-5, which are narrowly fused on the two or three last terga. Legs yellow and/or red-yellow, femora 1 and 2 with black base.

Male: 8-11 mm. Very similar to quinquefasciata. Central part of clypeus almost plane, very sparsely and shallowly punctate; anterior border usually with three small rounded teeth. Antennae long, median segments considerably longer than broad. Pattern almost as in quinquefasciata, yellow colour, however, somewhat more extensive, especially on abdomen, where terga 1 and 6 more frequently bear spots. In occasional specimens the legs may be almost uniform yellow and/or red-yellow. Striation in triangular area on propodeum very strong, regular. Pygidial area with margins not parallel, broader posteriorly. Sternum 6 on either side with strong bunch of golden hairs, directed obliquely outward and visible from above (Fig. 242).

Denmark: not common; mainly in the southern and south-eastern districts.  
- Sweden: sparsely distributed in southern and south-eastern districts, northernmost occurrence in Med. - Norway: a few records from AK, Tøien and SFi, Flesje. - Finland: south-eastern distribution, northwards to Kb. - Soviet Karelia: Ib and Kr. - Not common in Europe. Additional material from Kazakhstan and China.

Only very fragmentary information of the biology of the species exists. Nielsen (1900) states that imagines in Denmark are active later in the summer (August) than remaining species of *Cerceris*. This should, however, be modified, as specimens exist taken on July 4th and 11th.

The prey mainly consists of species of Curculionidae, e. g. species of the genera *Otiorrhynchus*, *Strophosomus*, *Sitona* and *Apion*, but species of Chrysomelidae (*Longitarsus* and *Bromius*) are also used. Bischoff (1927:358) states that nymphs of Hemiptera might constitute part of the provision. If this is the case, *ruficornis* shows a greater adaptability in its diet than e. g. *quinquefasciata*.

## Genus *Philanthus* Fabricius

*Philanthus* Fabricius, 1790:224.

Type-species: *Philanthus coronatus* Fabricius, 1790.

Head very strongly developed, in front view considerably wider than high. Inner orbits strongly diverging ventrally, with V-shaped emargination. Median ocellus larger than lateral ones. Antennae short and thick, inserted almost in middle on front. Clypeus large, its anterior border usually with characteristic teeth and excavations. Male with a thick fringe of stiff bristles along anterior border of clypeus, almost as in *Cerceris*. Mandibles simply attenuate, without teeth on the inner side, ventral margin with a very weak excavation. Face with extensive whitish pattern, covering entire clypeus and spreading up along inner orbits as two large, triangular spots. In addition a large two- or three-branched spot above antennal sockets. Since humeral tubercle reaches back to tegulae, scutum is compressed laterally into a small, spinelike prolongation. Scutum rather strongly convex, with strong, almost pitted sculpture. Scutellum strongly convex, anteriorly with a deep transverse furrow. Mesopleuron simply built, epicnemium only indicated, delimited by a transversely carinate furrow. Propodeum short, dorsally with indicated area condiformis. Abdomen sessile, flattened, usually with extensive yellow markings. Females with large, slightly differentiated pygidial area.

Tarsus 1 of females with strong pecten, in males comparatively weak. Tibia 2 with a single spur. Forewings with three cubital cells, of which second and third receive first and second discoidal transverse veins, respectively.

The genus is cosmopolitan and comprises a large number of species. Six occur in Europe, of which only one is represented in the Danish and Fennoscandian faunas.

The species nest in sandy localities, using Apidae (Hymenoptera) as provision.

65. *PHILANTHUS TRIANGULUM* (Fabricius, 1775)

Figs. 243 - 245.

*Vespa triangulum* Fabricius, 1775:373.

Female: 12-17 mm. Head in front view as Fig. 244. Frons in front of ocelli very densely punctate, with sparse, long grey-yellow pubescence. Whole lower part of face with ivory pattern. Above antennal sockets a large, V-shaped spot. Occasionally, an elongate spot above this. Clypeus with two strong median teeth and two considerably weaker lateral ones. Mandibles red yellow with black apex. Posterior part of head with extensive red-brown pattern. Pronotum dorsally, humeral tubercle distally, tegulae and metanotum with

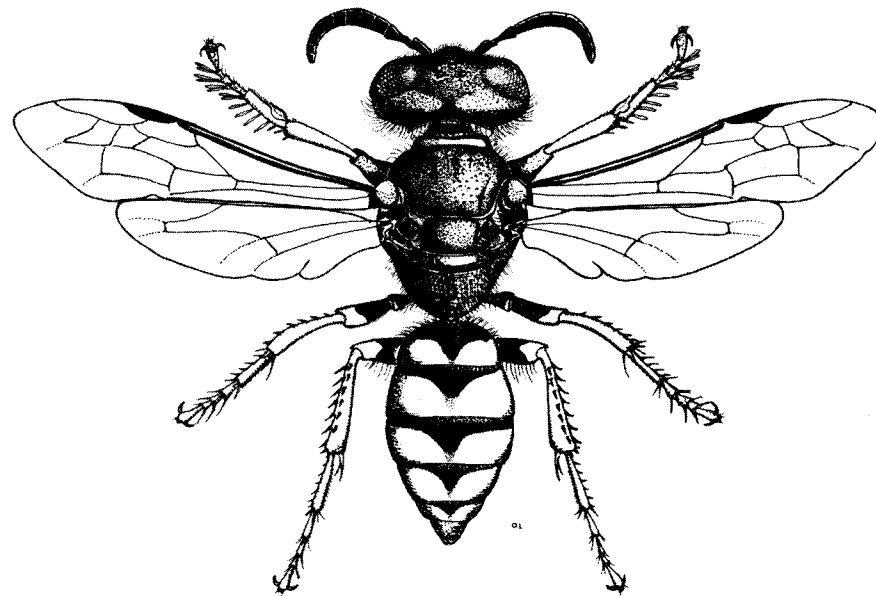

Fig. 243. Female of *Philanthus triangulus* (Fabr.). Length: 12-17 mm.



white-yellow markings. Punctuation on scutum dense and strong, scutellum shining, with very sparse punctuation. Mesopleuron very strongly and densely punctate. Propodeum dorsally with dense and very regular punctuation, laterally the punctuation becomes stronger, forming longitudinal rugulae. Thorax and propodeum with thin, grey-yellow pubescence all over. Abdomen with very extensive, but very variable, yellow pattern. Usually with black triangular areas on terga 1-4. Ventrally usually uniform yellow, but black spots may occur. Pygidial area broad and flat, apically with small U-shaped emargination. Legs yellow, basal part of femora black. Tibiae 2 and 3 and tarsi with strong, dark spines.

Male: 8-15 mm. Similar to female. Ivory pattern on face even more extensive than in female. Spot between antennal sockets three-pointed (Fig. 245). Fringe of bristles along anterior border of clypeus very well-developed. Colour pattern of mandibles much varying. Usually a basal spot and median area yellow. Behind eyes a large, oblique, yellow spot, surrounded by a red-brown ring. Pronotum, humeral tubercle, tegulae, scutellum and metanotum with yellow markings. Spot on scutellum may be absent. Punctuation on thorax and propodeum considerably stronger than in female. Abdomen with large, black triangular spots on both terga and sterna. Legs yellow, base of femora black.

Changes in climate have shown to affect the distribution of the species (Bræstrup & Nielsen, 1941). While all imagines emerge almost simultaneously all over the distribution-range of the species, the period of activity naturally becomes gradually shorter northwards, and late in the 1930's the species actually expanded its range, probably caused by unusually favourable weather conditions in July and August. The species has been recorded from several localities in the North (Erlandsson, 1962), but seems only to maintain very few stable populations. - Denmark: at least earlier common on the island of Bornholm. Nowadays common in several localities in North Zealand and on the island of Anholt (EJ). - Sweden: especially common on the islands of Öland and Gotland and along the sandy south coasts of Sk. Northwards to Vrm. and Upl. - Not recorded from Norway. - Finland: a few records from the southern districts. - Soviet Karelia: Ib. - It is one of the most widely distributed Sphecids, primarily occurring in the Mediterranean area in the Palaearctic region, and is found all over Africa and in Madagascar.

In its breeding biology, P. triangulum is one of the best known Sphecidae (see van Beusekom (1946), Olberg (1953), Simon & Simon (1972), Tinbergen (1932), Vergne (1935), and Rathmayer (1962)). The nests are made in sandy areas fully exposed to the sun, often in large aggregations, similar to Bembix

and Cerceris. Distance between entrances rarely less than about 10 cm, due to aggression. The nest proper, which is excavated in about three days, consists of a long main tunnel up to about one metre (!), whose first stretch declines about 30°. Thereupon it continues fairly horizontally. On the latter stretch the cells (3-34) are constructed at the end of short side tunnels, running at right angles to the main tunnel. During excavation the strong forelegs are mainly used, but small pebbles are removed with the mandibles.

Before the prey is caught, an orientation flight above the entrance to the nest is performed. The flight goes in increasing 8-shaped figures, where the intersecting lines in the figure lie just above the entrance. Prey consists of honey bees, Apis mellifera L., of which three to four specimens may be collected per day. Each cell contains three to six specimens. The bees are mainly attacked in flowers, but may also be taken in flight. The prey is paralyzed by being stung through the articular membranes, immediately behind the front legs (Rathmayer, 1962). It has often been observed that Philanthus licks the drops of nectar pressed out of the proventriculus of the bee by strong repeated squeezing of thorax with the mandibles (malaxation). The diet of imago consists of a considerable number of honey bees, which may be found lying on the ground, badly injured, round the breeding site of Philanthus. The victims are easily recognizable by the strongly compressed and shortened abdomen, as Philanthus has emptied the bee both of nectar and partly also of hemolymph. For provision of the nest a single female used up to 108 bees in its life-time, which hardly exceeds six weeks. Where P. triangulum breeds in dense populations this may cause decimation of the stock of honey bees (Johnsen, 1955). The egg hatches after 2-3 days, and in the course of about

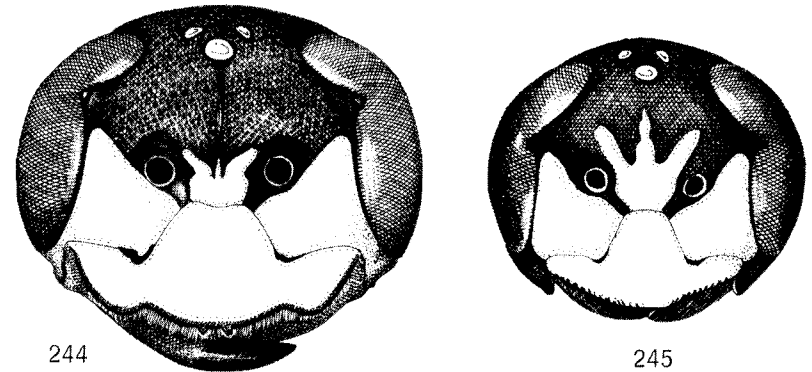

Figs. 244-245. Heads in frontal view of Philanthus triangulum (Fabr.). - 244: ♀; 245: ♂.

14 days the prey is completely eaten and the larva fully grown. It spins a very characteristic bottle-shaped cocoon, whose posterior end is attached to the back wall of the cell. The cocoon is suspended in the middle of the cell by means of fine threads. Larva and cocoon described by Grandi (1961).

P. triangulum occurs in a single generation in Denmark and Fennoscandia. From Central Europe specimens of a second generation are known.

As parasitoids are found Hedrychum intermedium Dahlbom (see Simon & Simon, 1972) and H. gerstaeckeri Chevr. (Hym., Chrysididae). Species of Metopia, Sphecapata and Conops (Dipt., Sarcophagidae and Conopidae) are known as cleptoparasites.

## SUBFAMILY NYSSONINAE

A rather heterogenous assembly of genera that probably constitutes a monophyletic unity, but this question is still open for discussion. Based on larval morphology Evans & Lin (1959) concluded that the larvae of the Nyssoninae form a clearly defined and closely knit group.

Most species rather large to medium-sized, with rich yellow and/or red pattern. Head wider than high. Eyes strongly convex, inner orbits parallel or converging ventrally. Clypeus large, anterior margin without projecting teeth or emarginations. Mandibles without ventral emargination. Antennae filiform in European species, inserted well above epistomal suture, in males often with conspicuous secondary sexual characters. Pronotum without transverse carina. Scutum antero-laterally with mesonotal laminae, i. e. a sharply delimited, lamellar dilation covering the base of the forewings. Epicnemium and epicnemial carina usually well-developed, but completely absent in Bembix. Propodeum usually with well-delimited dorsal area with strong sculpture. Abdomen sessile in European species. Last tergum in females with triangular pygidial area. Tibia 1 with two apical spurs, in Alysson with only one spur. Forewings with three cubital cells of which the second is petiolate in the Nyssonini. Both discoidal transverse veins usually join second cubital cell.

The following combination of characters separates the larvae from other Sphecidae: integument smooth; parietal bands absent or very short; antennal papillae present, of varying length; labrum retractable below clypeus, its anterior margin with at least some barrel-shaped sensillae; mandibles acuminate, about twice as long as maximum width; apex acute, the inner margin with from one to three teeth; maxillary palpus larger or only slightly shorter

than galea; spinneret paired, each opening at the end of a process of about the length of a labial palpus.

The subfamily comprises five tribes, all represented in Europe. The taxonomical status of the Heliocausini is doubtful, and Mellinus is here treated as constituting a separate subfamily. Cosmopolitan distribution. About 100 species in Europe. Terrestrial species.

## Genus Argogorytes Ashmead

Argogorytes Ashmead, 1899:324.

Gorytes Latreille, 1804:308.

Type-species: Gorytes carbonarius Smith, 1856.

Rather large species (Fig. 246) with yellow pattern, in habitus very similar to Gorytes. Head in front view comparatively long, median part of clypeus being somewhat protruded. Eyes slightly convex, inner orbits very weakly converging ventrally, dorsally with shallow emargination (Fig. 247). Antennae rather thick, entirely black in both sexes, those of males very long (Fig. 248). Scutum laterally above tegulae with narrow lamellae. Mesopleuron with well-

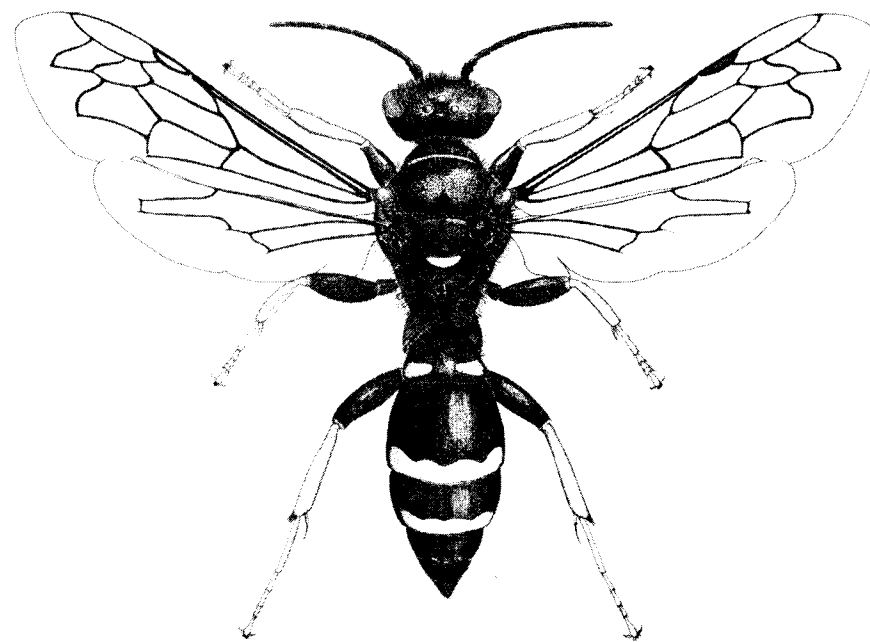

Fig. 246. Female of Argogorytes mystaceus (Linné). Length: 10-13 mm.

developed epicnemium, since the epicnemial carina joins the ventral midline. A very strong, transversely carinate, obliquely-running furrow originates dorso-laterally. Scutellum of females with a kidney-shaped, strongly depressed pit, with hairs at bottom. Thorax with rather dense and strong punctation. Propodeum very short, dorsally without well defined area cordiformis. Sternum 2 in profile with strong swelling, the furrow between sterna 1 and 2 being very deep (Fig. 81). Sternum 6 in females of North-European species with plane, broad, stout pygidial area with dense pubescence. Abdomen with yellow pattern on terga 1-3 or 1-4. All tarsi slender in both sexes. Foretarsi in female without pecten, their claws with a strong proximal spine. Pulvilli very small. Media of hind wings originates distal to apex of anal cell.

Argogorytes is distributed in the Palaearctis, with three species in Europe. In Nearctis another species occurs, which, however, belongs to a separate subgenus.

The species may be found nesting in dry and sunny, not necessarily sandy, localities, often on edge of woods, slopes, glades and the like. The nest is of a simple construction with a main tunnel, distally extended into a cell, or it may be branched and contain several cells. The prey consists of Homoptera, usually Jassidae.

Both mystaceus and fargei, and in some degree also Gorytes quinquecinctus, are important for pollination of the fly orchid, Ophrys insectifera (Orchidaceae). The males seek the flowers mainly by their olfactory sense, being attracted by a scent which is closely related to the pheromone emitted by the females in the mating season. The human olfactory sense cannot distinguish between the two scents. The vision of the wasps also plays an important rôle in locating the flowers. A long series of experiments made by Bertil Kullenberg (1961) clearly shows a greater affinity of the males to the fly orchid than to their natural partners. This is due to a combination of the strong scent of the flower, their morphology and colour, which especially are concentrated on the two big fused petals, the labellum.

During the visit of the male to the fly orchid a "pseudocopulation" is released, whose progress is only slightly similar to a true copulation, carried through in a calmer tempo, without orientating movements and without vibrating wings. During the attempt to copulate with the flower the male receives one or both pollinia, which after a resting period is transferred to the stigma of another flower. For details, see Kullenberg, 1961.

Key to species of Argogorytes

- 1 Anterior part of sternum 2 with very strong, deep pitlike punctures. Abdomen with well-developed yellow bands on terga 2 and 3. Tergum 4 without or with very weak yellow pattern. Female: femora mainly black with only a small distal red-yellow spot. Male: yellow and brown markings on tibia of equal extent. Antennae ventrally with undulating tyloidea ..... 66. mystaceus (Linné)
- Anterior part of sternum 2 with very superficial and indistinct punctures. Abdomen with well developed white-yellow bands on terga 2-4.  
Female: femora mainly red-yellow, but anterior ones with extensive black or brown-black marks. Male: tibiae mainly yellow, with only weak brownish streak on the inner side. Antennae ventrally with linear tyloidea ..... 67. fargei (Shuckard)

66. ARGOGORYTES MYSTACEUS (Linné, 1761)

Figs. 246-248.

Spheg mystaceus Linné, 1761:412.

Female: 10-13 mm. Head densely punctate, with rather long, erect, grey-

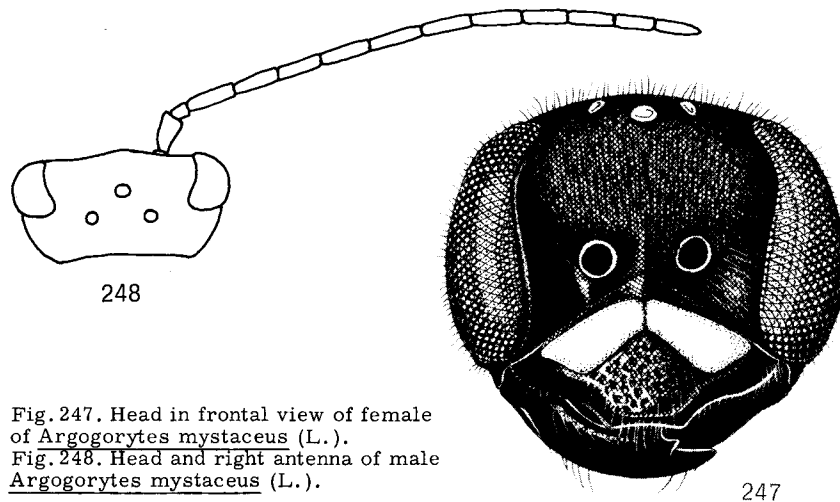

Fig. 247. Head in frontal view of female of Argogorytes mystaceus (L.).  
Fig. 248. Head and right antenna of male Argogorytes mystaceus (L.).

yellow pubescence. Clypeus large, weakly convex, along posterior border with two, sometimes coalescing yellow spots. These may be vestigial or absent in specimens from Fennoscandia. Clypeus anteriorly slightly concave; with sparse, coarse, partly coalescing punctures. The anterior border itself evenly arcuately emarginate. Pronotum with yellow transverse line. Scutum large, with dense and rather coarse punctures and rather sparse pubescence. Metanotum with yellow transverse spot, which may be absent from specimens from Sweden and Finland. Mesopleuron superficially punctate, with a coarsely pitted furrow, extending from the epicnemium to base of forewings. Danish specimens may sometimes have a small yellow spot on mesopleuron below base of forewings. Humeral tubercle yellow. Area on dorsal face of propodeum densely and somewhat irregularly longitudinally rugose, with a deep median furrow. Posterior face of propodeum very coarsely and irregularly, longitudinally rugose. First tergum rather densely punctate, with erect pubescence and two yellow lateral spots. Terga 2 and 3 posteriorly with yellow bands, with extremely short and thin pubescence. Tergum 4, especially in Danish specimens, may have a weak yellow transverse mark. Sternum 2, especially anteriorly, with very large, pit-like punctures. Legs red-yellow or brown-yellow, femora black.

Male: 10-13 mm. Yellow spots on clypeus usually coalescing dorsally, but never throughout their whole height. In Swedish and Finnish specimens the spots may be absent. Antennae very long, flagellar segments more than twice as long as broad (Fig. 248). Segments 3-7 ventrally with rather indistinct, undulating tyloidea. Colour pattern otherwise as in female, yellow spot on metanotum is, however, absent. Sculpture stronger than in female. Femora black. Tibiae yellow on the outer side, brown on the inner. Finnish specimens may lack yellow pattern on tibia 3.

Common and widely distributed throughout the Nordic countries. The northern distribution limit runs through Jmt. and Hls. in Sweden, NSy in Norway and Ob and Ks in Finland. The species avoids the mountain range in Central Scandinavia. - Soviet Karelia: Ib and Kr. - Common throughout much of the Palaearctic region, eastwards to the Pacific Ocean.

Main tunnel of nest usually reaches a length of about 10 cm vertically into the ground, than continuing in a more or less horizontal plane. On this stretch there are generally several larval cells, which are provisioned with nymphs of Cicadas, usually Philaenus spumarius L. Nysson spinosus Forst. (No. 75) may occasionally be found as cleptoparasite on this species.

67. ARGOGORYTES FARGEI (Shuckard, 1837)

Gorytes fargei Shuckard, 1837:214.

Gorytes campestris auctt.

Female: 10-12 mm. Very similar to the preceding species. The yellow spots on clypeus always coalesced, but sometimes very reduced in size in small individuals. Upper part of frons, scutum, scutellum and dorsal area of abdomen shining smooth, which is due to the finer and sparser punctation. Markings on pronotum, metanotum and abdomen very pale, almost white-yellow. Abdomen with bands on terga 2-4. Sterna 2 and 3 often have small lateral spots. Middle and hind legs often uniform red-yellow except base of femora. Tibia 1 and tarsus 1 red-yellow, femora black with red-yellow apex.

Male: 10-12 mm. Whole dorsal part of clypeus yellow. Antennae shorter than in preceding species. Segments 4-7 ventrally with sharply delimited tyloidea. Colour pattern as in female, except for the yellow transverse spot that is often lacking from metanotum. Tibiae yellow, at most with faint brownish spot on the inner side. Femora black with light apex.

Widespread, but not quite as common as the preceding species. - Denmark: not common, mainly occurring in the southern and south-eastern districts. - Sweden: rather common, especially in the central districts in Svealand, towards the north to Nb and Ly. Lpm. - Norway: a rather limited distribution in the southern districts. - Finland: apparently missing on Al., but otherwise found from Ab and N to ObN and Ok. - Soviet Karelia: Ib and Kr. - Apparently not found outside Europe.

The nest is often found in the same localities as Hoplomerus spinipes Linné or H. reniformis Gmelin (Hymenoptera, Eumenidae). From the about 10 cm long vertical main tunnel 6-9 cells are constructed. The number of prey varies considerably, but usually 18-25 nymphs of Philaenus spumarius L. are deposited in each. Nysson spinosus Forst. (No. 75) is recorded as cleptoparasite.

## Genus Gorytes Latreille

Gorytes Latreille, 1804:180.

Type-species: Mellinus quinquecinctus Fabricius, 1793.

Medium-sized species (Fig. 249), usually with strong yellow pattern. Head in front view very broad. Eyes large and strongly convex, especially in males, the inner orbits converging ventrally. Clypeus large, its anterior border not projecting, without distinct emarginations, teeth or the like. Antennae long

and slender, often yellow or brown-yellow ventrally. Mandibles short and strong, tridentate in females, bidentate in males. Scutum above tegulae with sharply delimited, posteriorly gradually broader, lamella (mesonotal laminae). Posteriorly the lamella has a short oblique carina. Mesopleuron with an incompletely delimited epicnemium, since the epicnemial carina does not reach the ventral midline. Instead it extends backwards into the pleural suture, continuing in front of coxa 2 and joins the suture between meso- and metanotum. Dorsally on mesopleuron a broad furrow extends backwards from the epicnemium. Thorax very finely and superficially punctate. Propodeum with rather distinctly delimited area cordiformis with very coarse sculpture, consisting of more or less regular ribs and carinae. Abdomen with yellow transverse bands on terga 1-4. Females with a broad, usually coarsely punctate, hairless pygidial area. Legs strong, pretarsi and pulvilli very well-developed, especially in females. Tarsus 1 in females with very strongly developed pecten. Tibia 2 with two spurs. Forewings with three cubital cells. Both discoidal transverse veins join second cubital cell. Often a dark shadow covers radial cell and a larger or smaller area below this. Media of posterior wing originates from anal cell (Fig. 57).

The genus is represented by several species throughout much of Holarctis, and also occurs in the tropics. In Fennoscandia and Denmark four species occur, of which one, neglectus, seems to be endemic to Lapland and East Karelia.

The nests are constructed in the ground, and usually consist of a branched tunnel system. The prey consists of Homoptera, usually Philaenus spumarius (L.) (Cercopidae).

Key to species of Gorytes

Females

- 1 Pygidial area very densely longitudinally striate. Legs often uniform red-yellow ..... 68. quinquecinctus (Fabricius)
- Pygidial area shiny, punctate, without striation. Femur 3 mainly black ..... 2
- 2(1) Ribs in area cordiformis very irregular, forming a reticulate-rugose sculpture. Longitudinal carinae often fusing, transverse carinae of almost equal strength. Yellow mark along inner orbit large and triangular, joining epistomal suture (Fig. 252). Yellow band on tergum 2 distinctly broader than those on remaining ones ..... 69. laticinctus (Panzer)

- Ribs in area cordiformis approximately parallel, transverse ribs very weak or absent. Yellow mark along inner orbit narrow, linear, not reaching epistomal suture (Fig. 251a). All transverse bands of abdomen of fairly equal breadth ..... 3
  - 3(2) Clypeus with broad black anterior and posterior borders. Intermediate pattern often of the shape of a buffalo horn (Fig. 251a). Yellow colour often very reduced. Tibia and tarsi mainly red-yellow .. 70. quadrifasciatus (Fabricius)
  - Clypeus, except narrow black anterior border, completely yellow. Tibiae mainly black ... 71. neglectus Handlirsch
- Males
- 1 Tyloidea in at least the proximal flagellar segments broad and light brown. Humeral tubercle usually with yellow spot ..... 68. quinquecinctus (Fabricius)
  - Tyloidea black ..... 2
  - 2(1) Tyloidea on antennal segments 4-8 broad, oval, weakly concave in the middle and of slightly paler

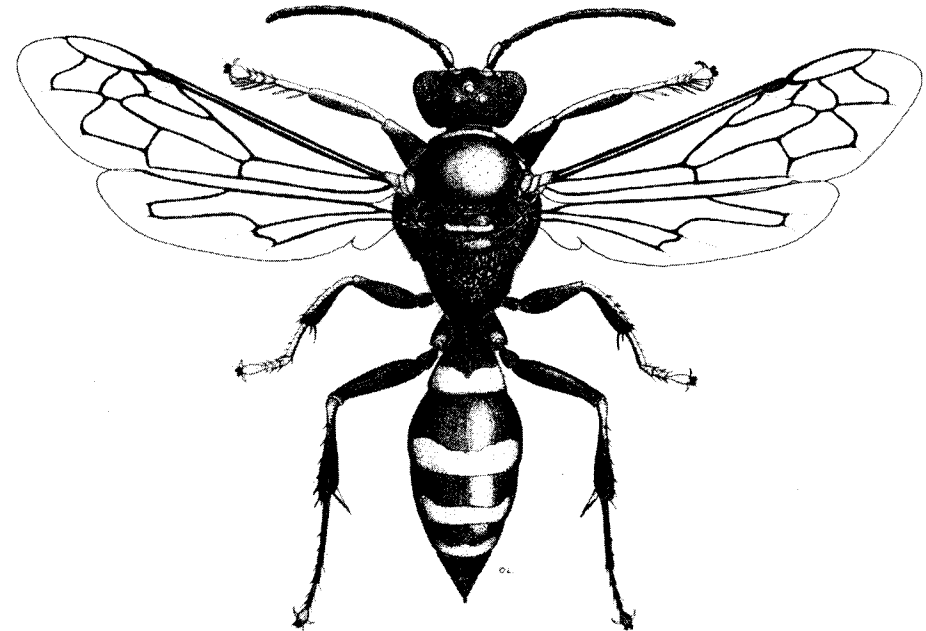

Fig. 249. Female of Gorytes quadrifasciatus (Fabr.). Length: 9-11 mm.

colour. Area cordiformis with regular, parallel, longitudinal ribs, without transverse striation. 71. neglectus Handlirsch  
 - Tyloidea narrow, sharply delimited, almost linear.  
 Ribs in area cordiformis very irregular ..... 3

- 3(2) Distance from lower border of yellow mark along inner orbit to epistomal suture usually greater than greatest width of the mark. (Isolated specimens without yellow pattern on face). Yellow band on tergum 2 usually of same width as remaining ones ..... 70. quadrifasciatus (Fabricius)  
 - Distance from lower border of yellow mark along inner orbit to epistomal suture less than greatest width of mark. Area just in front of antennal sockets usually with small yellow spot. Yellow band on tergum 2 broader than remaining ones ..... 69. laticinctus (Panzer)

68. GORYTES QUINQUECINCTUS (Fabricius, 1793)

Fig. 250.

Mellinus quinquecinctus Fabricius, 1793:287.

Hoplisis sinuatus Costa, 1869:81.

Female: 9-13 mm. Head in front view as Fig. 250. Eyes very large, strongly convex, inner orbits strongly converging towards the epistomal suture. Frons in front of ocelli partly with coarse but sparse punctures, partly with fine and dense intermediate punctation. The following parts are yellow: clypeus except anterior border itself; two narrow stripes along inner orbits; antennae ventrally; usually a small proximal spot on mandibles; a transverse stripe on pronotum; a spot on the humeral tubercles, a spot just behind these on mesopleuron; a spot on tegulae and a transverse mark on scutellum. Specimens from South Europe often have also two large spots on propodeum (G. quinquecinctus sinuatus Costa). Legs extensively yellow, tibia 3 usually uniform yellow, tibiae 1 and 2 with more or less extensive black marks. Specimens from Finland usually have mainly black femur 3 and tibia 3, only extreme proximal and distal tips yellow. Abdomen with 5 complete yellow transverse bands. Pygidial area dull, finely longitudinally striate, with sparse punctation.

Male: 8-12 mm. Head in front view almost as in female. Antennae black, with broad, light brown tyloidea on segments 4-8. Specimens from Fennoscandia have only segments 5-7 provided with light brown tyloidea. Scapus

often yellow. Yellow pattern on face may be very reduced or absent, as may also spot on humeral tubercle. Yellow pattern on thorax may be reduced to quite narrow transverse bands on pronotum and scutellum, as the spot on mesopleuron may be absent. Abdomen always with yellow transverse bands on terga 1-6. Femora mainly black with a small yellow distal spot. Femur 3 with proximal spot. Tibia 1 and tarsus 1 mainly yellow, tibia 3 and tarsus 3 occasionally brown-black with only indicated yellow pattern.

The species occurs very locally in southern Fennoscandia. Sweden: rather large and stable populations on Öland. It has not been possible to verify the records published by Aurivillius (1904). - Finland: rather limited records from Ab, N, Ta and Sa. - Soviet Karelia: Kr. - The species seems to have a southern and eastern occurrence in Europe. The records from North Africa might refer to another species (Beaumont, 1953). Also recorded from Kazakhstan.

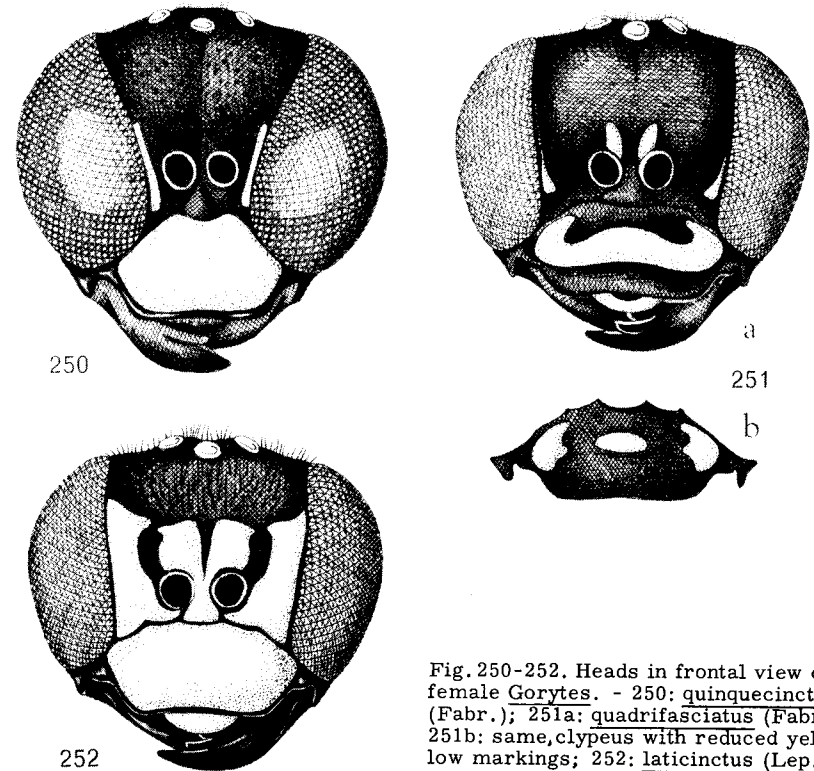

Fig. 250-252. Heads in frontal view of female *Gorytes*. - 250: quinquecinctus (Fabr.); 251a: quadrifasciatus (Fabr.); 251b: same, clypeus with reduced yellow markings; 252: laticinctus (Lep.).

It is interesting that males of also this species have been observed as pollinator of the fly orchid, Ophrys insectifera (Orchidaceae). Observations are, however, few, and compared with the species of Argogorytes, the species plays a considerably minor rôle in this connection (Kullenberg, 1961). - Nysson interruptus (Fabr.) (no. 76) is found as cleptoparasite.

69. GORYTES LATICINCTUS (Lepeletier, 1832)

Fig. 252.

Euspongus laticinctus Lepeletier, 1832:66.

Female: 10-13 mm. Head in front view as Fig. 252. Frons with pronounced double punctation, the large punctures, however, not nearly so strong as in quinquecinctus. Face with very extensive yellow pattern. The large triangular spots along inner orbits often coalescing with the more or less smaller Y-shaped spot between antennae in specimens from southern Denmark. Mandibles usually black, but may carry one or two yellow spots. Labrum yellow, clypeus with narrow black anterior border. Antennae ventrally yellow, distally gradually darker yellow-brown. Pronotum usually with well-developed yellow transverse band. Humeral tubercle always black. Mesopleuron with large yellow spot right behind this, rarely with a small additional spot dorsal to this (isolated specimens from Denmark, SJ). A single Danish specimen, Funen (Æbelø) also has a yellow spot ventrally to the large spot. Tegula usually with yellow spot, and scutellum has a yellow transverse band. Terga 1-4 with yellow transverse bands. Sometimes in addition very weak yellow markings on tergum 5. Band on tergum 2 considerably broader than the remaining ones. Sterna 2-4 often with yellow transverse bands along posterior borders, which, however, may be absent from Fennoscandian specimens. Pygidial area shiny, with sparse punctation. Legs, especially the foremost pair, with very extensive yellow markings. Coxae generally with yellow spots.

Male: 9-12 mm. Eyes distinctly more strongly convex than in female, inner orbits strongly converging ventrally. Yellow pattern on face as in female, but distinctly reduced, as especially the spot between base of antennae is often absent. Occasionally the extent of the yellow colour on clypeus is reduced. Scutellum always lacks yellow markings in specimens from Fennoscandia and Denmark, and the transverse mark on pronotum may be very reduced in size. Spot on mesopleuron just behind humeral tubercle often absent from Danish specimens, more frequently from Scandinavian specimens. Abdomen with well-developed, yellow transverse bands along posterior border of first, third, sometimes also on fourth tergum. Band on tergum 2 always much broader than the remaining ones.

The species is common in Denmark and is recorded from most districts. - Sweden: rather common in the southern districts, distributed northwards to Vrm., Nrk. and Upl. - Norway: a few specimens from AK, SFi and HOi. - Finland: not common, occurs in the southern and south-eastern districts up to Kb. - Soviet Karelia: Ib and Kr. - Widely distributed in the western Palaearctic region, eastwards to the Kirgizian steppes, southwards to Africa.

The species nest on slopes exposed to the sun, with comparatively loose soil, often partly covered with vegetation. The nests may also be constructed in horizontal ground. The main tunnel extends about 10 cm down into the soil, whereupon it may continue a small distance upwards. At the end of short side tunnels, issuing from the rising stretch, there are usually 3-4 cells, which are provisioned with Cicadas, notably Philaenus spumarius L.

Nysson trimaculatus (Rossi) (no. 77), N. niger Chev. (no. 78), N. spinosus (Forst.) (no. 75) and Metopia campestris Fall. (Diptera, Sarcophagidae) are recorded as cleptoparasites.

70. GORYTES QUADRIFASCIATUS (Fabricius, 1804)

Figs. 249, 251.

Mellinus quadrifasciatus Fabricius, 1804:298.

Euspongus vicinus Lepeletier, 1832:68.

Hoplisus montivagus Mocsary, 1878:250.

Female: 9-11 mm. Head in front view as Fig. 251. Clypeus usually with yellow pattern similar to a buffalo horn. This may, however, be very reduced and consist of an oblong median spot and two small lateral ones (Fig. 251b). Yellow pattern on labrum may be divided into two lateral spots. A pair of spots on lower part of face, slightly above epistomal suture, and a pair, just behind antennal sockets, yellow. Scapus yellow ventrally. Flagellum black, basal segments light brown-yellow ventrally. Rugae in area cordiformis usually almost linear, very strong. Remaining part of propodeum somewhat more weakly and irregularly rugose. Abdomen shiny, with yellow bands on terga 1-4. Pygidial area shiny with sparse, rather coarse punctures. Femur 1 black, more or less yellow ventrally. Femora 2 and 3 black with light apex. Tibiae and tarsi red-yellow. Yellow pattern on femora usually reduced in specimens from Finland, as tibiae in this material may also be mainly black.

Male: 9-11 mm. Antennae black, rather long and slender, with sharply delimited, black tyloidea. Scapus always yellow spotted ventrally. Dorsal three-fourths of clypeus usually yellow. Pattern may, however, be reduced to two lateral spots. Spots along inner orbits of eyes narrow, parallel, never

reaching epistomal suture. Spots behind antennal sockets missing. Pronotum always with yellow transverse spot in Danish specimens, often missing this in Finnish material. Sculpture of propodeum much varying, rugae of area cordiformis always mainly longitudinally orientated. Abdomen with yellow bands on terga 1-4 and on sterna 2-3. Femora black with light apex. Tibiae brown with larger or smaller yellow spot on the inner side.

Denmark: widely distributed, but rare outside the eastern districts. - Sweden: common, distributed from Sk. to Nb. The northern distribution limit in Sweden continues into Finland and runs through ObN. - Norway: rather common in the south, northernmost occurrence in On, Fron. - Soviet Karelia: Ib and Kr.- The species is recorded from most European countries, but seems to become more rare southwards.

Nests in similar localities as laticinctus, but also in very clayey soil. Prey consists likewise of Philaenus spumarius (L.) (Hom., Cercopidae).

Several species of Nysson are stated as cleptoparasites. Imagines are often observed licking nectar in flowers of e.g. Hieracium and Angelica.

#### 71. GORYTES NEGLECTUS Handlirsch, 1895

Gorytes neglectus Handlirsch, 1895:916.

Female: 9-11 mm. Clypeus mainly yellow, with only comparatively narrow black stripe along anterior border. Spots along inner orbits long, parallel. Head, except labrum, otherwise without yellow pattern. Punctuation of frons very fine and dense, almost as in quadrifasciatus. Antennae black, brown-yellow ventrally. Thorax usually wholly without yellow pattern, although specimens with two small yellow spots on pronotum may occur. Notum dull due to microsculpture, on the whole with more distinct punctuation than in the remaining species. Dorsal striation on propodeum denser and more regular than in quadrifasciatus; the only transverse striae in area cordiformis are found in the bottom of the middle furrow. Abdomen with rather narrow yellow bands on terga 1-4. Completely black ventrally. Pygidial area as in laticinctus and quadrifasciatus, only somewhat more sparsely punctate, anteriorly with distinct microsculpture. Femora black except a quite small distal brownish spot. Tibia 1 and four first tarsal segments with yellow front side. Tibia 2 black with yellow spot distally and proximally. These may be connected with each other. Tarsi mainly yellow. Tibia 3 black, except a faintly brownish spot distally, and posterior tarsi brown dorsally and ventrally.

Male: 9-11 mm. Antennae somewhat shorter and thicker than in laticinctus and quadrifasciatus, segments 4-8 ventrally with broad, oval tyloidea,

whose slightly concave middle is a little lighter than remainder of segment. Clypeus yellow, except for a narrow black stripe along anterior border. A long stripe parallel to inner orbits and a small triangular spot anteriorly between antennal sockets also yellow. Pronotum with yellow transverse line interrupted in the middle. Thorax otherwise black, densely and uniformly punctate and dull due to the fine microsculpture. Ribs in area cordiformis strong, regular, parallel, almost as in female of quadrifasciatus. All femora, tibia 3 and tarsi black. Tibiae 1 and 2 with yellow pattern on the inner side, tarsi yellow.

A very rare, high-boreal species. In Fennoscandia only recorded from Finnish Lapland, predominantly north of the Polar Circle. - Soviet Karelia: a few specimens from Kr and Lr. - Dalla Torre (1897) mentions the species from Caucasus (?) and Siberia (?).

Note. Recorded as Gorytes fallax Handlirsch by Grönblom (1918), Pulkkinen (1931) and Hellén (1954), corrected to G. neglectus by Hellén (1955). G. fallax is a Central and East European species.

## Genus Dienoplus Fox

Dienoplus Fox, 1893:548.

Harpactes auctt.

Gorytes Latreille, p. p.

Type-species: Dienoplus pictifrons Fox, 1893.

Comparatively small species (Fig. 253), which in habitus are very similar to Gorytes, but from which the genus is distinguishable by the following characters. Inner orbits parallel. Mandibles bidentate in both sexes. Terminal antennal segments in males without tyloidea, but with more or less distinct excavations ventrally. Scutum above tegulae with vestigial furrow. Oblique carina near posterior corners of scutum missing. Epicnemium indistinct, the faint epicnemial carina continues into the pleural suture as in Gorytes. Propodeum dorsally with a triangular area, delimited by distinct carinae. The area itself with weak sculpture. Abdomen with white-yellow pattern on terga 2-5. Media of hindwings originates distal to anal cell.

The species nest in sand. The prey consists of Cicadas (Homoptera). The genus comprises less than ten species, all distributed in Holarctis.



Key to species of Dienoplus

- 1 Two first abdominal segments red except two small whitish spots on tergum 2 ..... 72. tumidus (Panzer)  
 - Whole abdomen except spots on terga 2 and 5 black ..... 73. lunatus (Dahlbom)

72. DIENOPLUS TUMIDUS (Panzer, 1801)

Fig. 253.

Pompilus tumidus Panzer, 1801:H. 81, T. 15.

7-8 mm. Head black, shiny, partly with sparse punctures, partly with extremely fine and dense punctation. Lower part of inner orbits with large white-yellow triangular spot, joining lateral spots on clypeus; these spots greatly varying in extent. Clypeus, especially in males, covered with a dense, silvery pubescence. Behind the eyes a red-brown streak. Mandibles red-yellow to rusty with darker apex. Antennae of female black, scapus yellow ventrally. Distal segments of flagellum light ventrally. Antennae of male longer and more slender, scapus and last seven to eight segments yellow ventrally. Antennal segments 10-11 weakly excavate ventrally. Thorax shiny with sparse punctation, rather dense greyish pubescence. Scutellum with yellow transverse spot. Triangular area on dorsal face of propodeum anteriorly with short longitudinal ribs, shiny. Remaining part of propodeum with very indistinct sculpture, at most with indication of rugae laterally, here with thin silvery pubescence. First two segments of abdomen red, tergum 2 with white-yellow lateral spots, tergum 5 with white-yellow median spot. Legs mainly red.

Rather limited material from Denmark, where the species seems to have a southern and south-eastern distribution. - Sweden: widely distributed, but not common, from Sk. to Hls. in the north. - A few specimens from southern Norway: AK, VAy. - Finland: not uncommon, especially in the south-eastern districts; towards the north to Ok and Om. - Soviet Karelia: Ib and Kr. - The species is widely distributed in North and Central Europe, Southern Siberia (Kazakhstan) and Japan (a distinct subspecies).

The nests are constructed in sandy soil. Each nest probably contains several cells, which are excavated at the end of a vertical tunnel, about 7 cm long. The prey consists of imagines or nymphs of e.g. species of Acrocephalus or Philaenus spumarius L. (Acrocephalidae and Cercopidae), of which 5-6 are deposited in each cell.

As parasites are known several Nysson and Hedychridium roseum Rössli (Hym., Sphecidae and Chrysididae).

73. DIENOPLUS LUNATUS (Dahlbom, 1832)

Larra lunatus Dahlbom, 1832:52.

6-7 mm. Very similar in habitus to tumidus, but easily distinguishable from this by the black base of abdomen and the completely black scutellum. Moreover, the spots on tergum 2 are often fused into a transverse band. Clypeus of males usually uniform yellow.

The species is often found in the same localities as the preceding one, but it seems to occur a little further north in Fennoscandia. Main distribution in Central and North Europe.

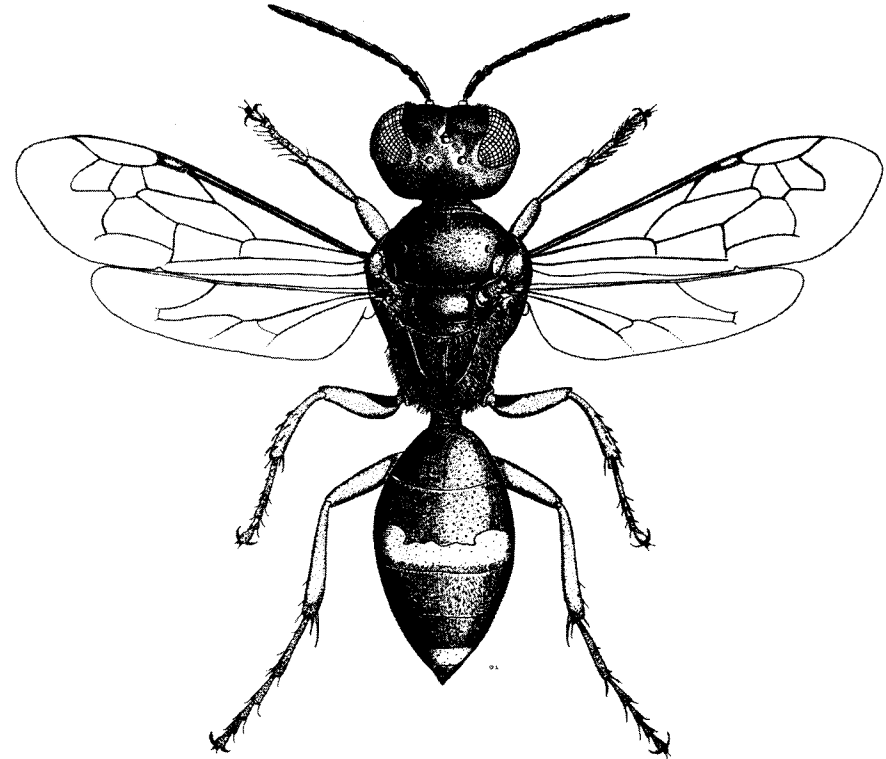

Fig. 253. Female of Dienoplus tumidus (Panzer). Length: 7-8 mm.

## Genus *Bembix* Fabricius

*Bembix* Fabricius, 1775:361.

Type-species: *Apis rostrata* Linné, 1758.

Genus very easily recognizable, partly by its considerable size, partly by its habitus (Fig. 254), its pattern and the very prolonged labrum. Labrum may be deflected backward thereby covering the labio-maxillary complex. In this position it is held by the mandibles. These are short, almost straight, with a very weak tooth on the inside. Eyes very large and strongly convex. Ocelli, on the other hand, rather weakly developed, elongate and very slightly convex. Lateral ocelli only indistinctly seen through the long strong pubescence. Antennae long and strong, in male dilated and flattened distally. Thorax robust, dorsally slightly convex, finely and densely, somewhat superficially punctate and with rather short, dense pubescence. Abdomen broad, cone-shaped, with yellow transverse bands. Legs powerful, with black and yellow pattern. Male as well as female with pecten on tarsus 1. Both discoidal transverse veins join second cubital cell. Anterior edge of hindwing with about 40 very closely placed frenal hooks.

The genus is cosmopolitan and comprises more than 100 species. Fifteen occur in Europe, of which only one is in the North. The nests are constructed in the soil, on dry, sandy ground. The prey consists of Diptera Brachycera.

### 74. *BEMBIX ROSTRATA* (Linné, 1758)

Fig. 254.

*Apis rostrata* Linné, 1758:577.

Female: 13-25 mm. Head in front view considerably wider than high. Inner orbits very slightly diverging ventrally. Clypeus strongly convex, yellow. Frons excavated in a furrow between the swollen area carrying the ocelli and the inner orbits. Area between antennal sockets with short longitudinal keel. A ring round the eyes, labrum, clypeus and frontal face of scapus yellow. Pilosity long, white. Thorax with uniform, fine punctation. A large transverse spot on pronotum, posterior part of humeral tubercle, tegulae and lateral parts of propodeum yellow. Abdomen with greenish-yellow undulating bands, which may be interrupted on first and usually also on second tergum. Legs mainly yellow, only femora with a proximal black spot. Spines of tarsus 1 extremely strong, broadest in anterior part. Tibiae 2-3 with 2-3 rows of strong spines.

Male: 13-23 mm. Yellow pattern distributed as in female. Scapus distally rather strongly dilated, ventrally with transparent, semi-circular area. Three last segments of flagellum flattened and dilated, ventrally excavate. Antennal segments 9-10 ventrally with a small truncate tooth. Posterior border of femur 2 with a row of sharp, irregular teeth. Sterna 2 and 6 with backwardly directed, curved, broad-based spine.

In Denmark the species maintained rather stable populations in North Zealand and on Bornholm until about 1964. - Sweden: there is a rather large material from Sk., Bl., Ö1. and Gtl. Further records from Sdm. and Upl. - The species is not known from Norway.- Finland: a single specimen was observed near Joensuu (Kb) early in August 1974 by O. Martin (pers. comm.).- Also recorded from Ib in Soviet Karelia. - A few records from Northern Germany (Schleswig-Holstein) (Eriandsson, 1965). - Common and widely distributed in Central and South Europe, and in North Africa. The distribution area extends eastward through Central Asia to Mongolia.

The species nests on plane, preferably sandy areas, completely exposed to the sun, with sparse vegetation, i. e. in a similar type of locality to *Philanthus*, *Cerceris* and *Tachysphex*. Large aggregations of nests are often

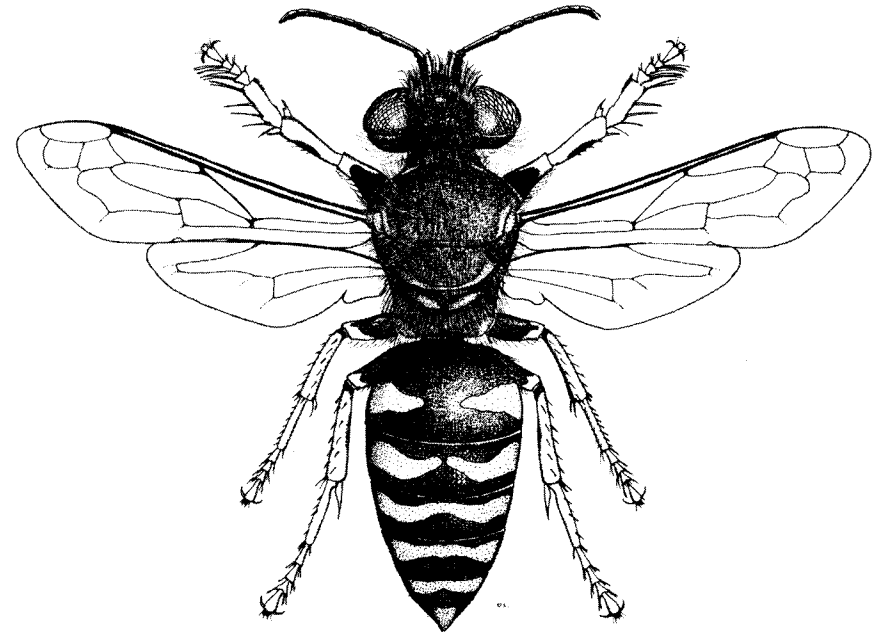

Fig. 254. Female of *Bembix rostrata* (L.). Length: 13-25 mm.

found, generally constructed in localities previously used by the species. Excavation of nest normally takes about 12 hours, weather permitting. The finished nest consists of a short, declining (c. 40°) tunnel, 10-15 cm long, distally extended into a single celle. The last part of the tunnel runs practically horizontally. The sequence of construction was excellently described by E. Tetens Nielsen, 1945. The prey consists of a large variety of species of Diptera Brachycera. The first prey caught is a comparatively small fly, e. g. of the families Tachinidae or Muscidae, to which the egg is attached. Then the nest is sealed, and while the egg is hatching, and the young larva devouring the fly, the mother wasp excavates another nest. The next prey consists of a larger fly, e. g. Syrphidae or Therevidae, and finally flies are caught and brought home which are of almost equal size to the wasp itself, e. g. Tabanidae, Asilidae og Bombyliidae. Such progressive provisioning is only known from other closely related genera. The egg hatches in the course of a few days, and in about a week the larva has devoured the prey. After a resting period formation of the large firm cocoon takes place, and metamorphosis occurs inside this. As cleptoparasites and parasitoids are stated species of Conopidae and Sarcophagidae (Diptera) and Parnopes grandior Pallas (Hymenoptera, Chrysididae).

## Genus *Nysson* Latreille

Nysson Latreille, 1802:340.

Type-species: Crabro spinosus Fabricius, 1775 (= Sphex spinosus Forster, 1771).

Medium-sized to rather small species (Fig. 255) with yellow and sometimes also red pattern, especially on abdomen. Head in front view very broad, approximately cordiform. Eyes very strongly convex. Inner orbits strongly converging ventrally, whereby distance across mandibular articulations becomes shorter than uppermost frontal distance between eyes (Fig. 256). Mandibles short, strongly curved, ending in a single tooth. Antennae short and thick, in males thickened distally, usually with excavations usable as key characters. Antennae inserted very close together below a slightly elevated area. Head with dense and coarse sculpture. Clypeus large; especially in males with dense, silvery pubescence which extends some distance along inner orbits. Thorax short and broad with strong, dense sculpture except on epicnemium. Propodeum coarsely striate or rugose, laterally with two stout, backwardly directed, teeth or spines. Thorax usually with dense, adpressed,

silvery pubescence ventrally. Abdomen sessile, in females with distinctly delimited pygidial area. Tergum 7 of male flat, laterally prolonged as two attenuate spines. Legs stout, but tarsi long and slender, considerably longer than tibiae. Foretarsus of female without pecten. Tibia 2 with two apical spurs. Forewing with three cubital cells, of which the second is petiolate and joined by both discoidal transverse veins.

The species live as cleptoparasites on species of Gorytes, Dienoplus and Argogorytes. For details: see no. 79. The genus is represented by a large number of species in Holarctis.

### Key to species of Nysson

#### Females

- |   |  |   |
|---|--|---|
| 1 | First abdominal segment red. Sternum 2 seen in profile weakly swollen (Fig. 258) ..... | 2 |
| - | First abdominal segment black. Sternum 2, except                                       |   |

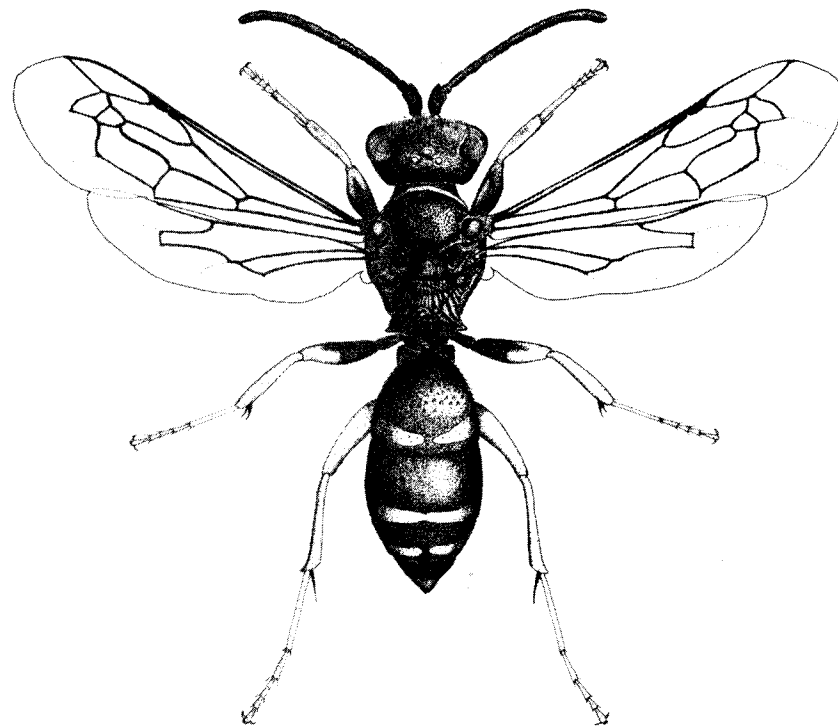

Fig. 255. Female of Nysson spinosus (Forster). Length: 10-12 mm.

- in niger, seen in profile strongly humped or angularly protruding (Fig. 257) ..... 5
- 2(1) Pronotum, and usually also scutellum, with white-yellow transverse spot. Femur 3 uniformly red-yellow ..... 79. maculosus (Gmelin)
- Pronotum and scutellum always without yellow pattern. Femur 3 more or less darkened ..... 3
- 3(2) Occipital carina stout and strongly projecting, joining the hypostomal carina (Fig. 259). Last sternum with a shiny, impunctate, longitudinal keel. Punctuation on remaining part of the sternum rather coarse, drawn out into a rugose sculpture. Propodeum on either side of articulation of abdomen without tooth ..... 80. tridens Gerstäcker
- Lower part of occipital carina absent. Instead an area with weak longitudinal rugae is found near the hypostomal carina. Last sternum finely punctate, without longitudinal keel. Propodeum on either side of articulation of abdomen with small tooth ..... 4
- 4(3) Scutum with uniform and evenly distributed, rather strong punctuation. Interstices between the stout ribs on dorsal face of propodeum with weak irregular sculpture at the bottom, whereby the lustre of the shiny surface is dimmed. Abdomen with yellow lateral spots on terga 1 and 2 or only 2 ..... 81. dimidiatus Jurine
- Scutum with marked double sculpture, which partly consists of a dense punctuation (as in dimidiatus), partly of large, rather shallow pits. These may sometimes be difficult to distinguish. Interstices between the very stout ribs on dorsal face of propodeum without sculpture, shining. Abdomen usually with yellow lateral spots on terga 1-3. 82. mimulus Valkeila
- 5(1) Media of hindwing originates distally to apex of anal cell (Fig. 255). Anterior border of clypeus arcuately emarginate centrally, with two small, longitudinal keels (Fig. 256) ..... 6
- Media of hindwing originates from apex of anal cell (Fig. 260). Anterior border of clypeus without such emargination ..... 7

- 6(5) Tooth on metanotum immediately above articulation of coxa 3 with rather dense and strong pubescence. Yellow bands on terga 2 and 3 not or only very

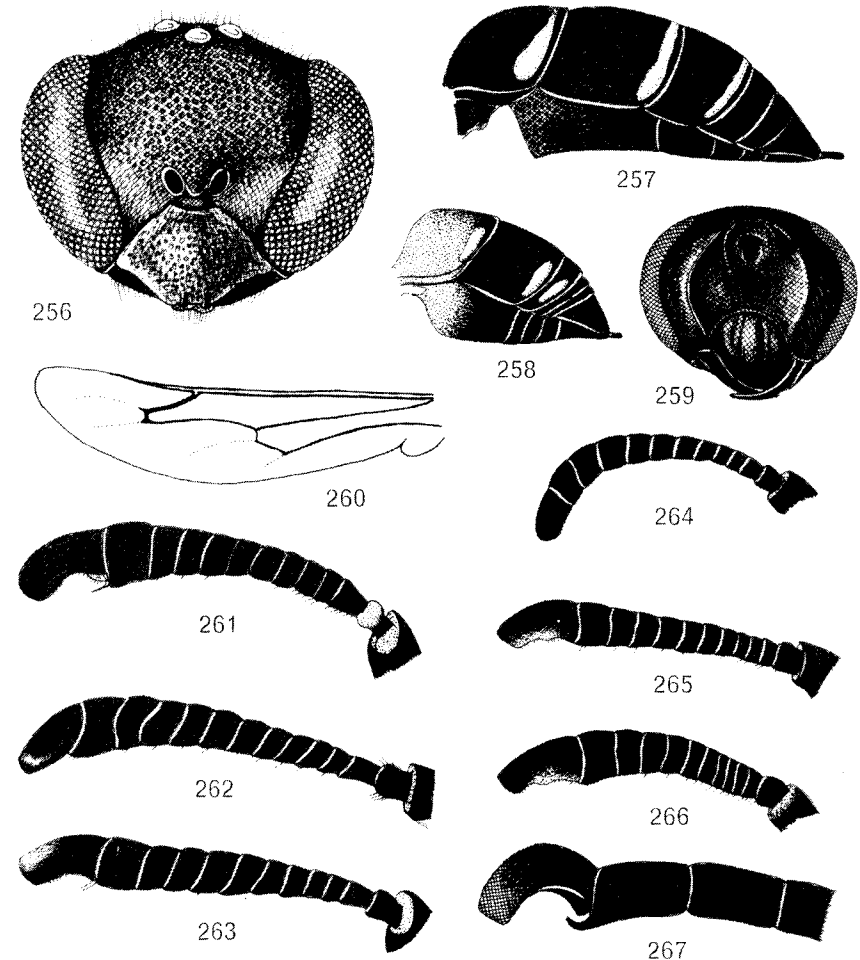

Fig. 256. Head in frontal view of female Nysson spinosus (Forster).  
 Figs. 257-258. Abdomen in lateral view of female Nysson. - 257: spinosus (Forster); 258: maculosus (Gmelin).  
 Fig. 259. Head in posterior view of female Nysson tridens Gerstäcker.  
 Fig. 260. Hindwing of Nysson trimaculatus (Rossi).  
 Fig. 261-266. Antennae of male Nysson. - 261: maculosus (Gmelin); 262: trimaculatus (Rossi); 263: niger Chevrier; 264: tridens Gerstäcker; 265: dimidiatus Jurine; 266: mimulus Valkeila.  
 Fig. 267. Distal part of antenna of male Didineis lunicornis (Fabr.).

- narrowly interrupted in the middle. Humeral tubercle black. Pattern of abdomen bright yellow. 75. spinus (Forster)
- Tooth on metanotum with short and very thin pubescence. Yellow bands on terga 2 and 3 usually broadly interrupted in the middle. Humeral tubercle generally yellow. Pattern of abdomen white-yellow ..... 76. interruptus (Fabricius)
- 7(5) Scutellum dorsally with yellow transverse spot. Femur 3 and tibiae black ..... 77. trimaculatus (Rossi)
- Scutellum without yellow spot. Femur 3 and tibia 3 red-yellow. Tergum 2 in profile slightly swollen ..... 78. niger Chevrier
- Males
- 1 First abdominal segment red ..... 2
- First abdominal segment without red pattern ..... 4
- 2(1) Last antennal segment much shorter than combined length of segments 11 and 12, only very slightly excavate ventrally (Fig. 264). Antennal segment 12 seen from above longer than broad. Anterior part of clypeus very coarsely and densely punctate. 80. tridens Gerstäcker
- Last antennal segment as long as or longer than combined length of segments 11 and 12, ventrally with deep, double emargination (Figs. 265, 266). Antennal segment 12 seen from above broader than long. Anterior part of clypeus finely punctate, admixed with coarser punctures ..... 3
- 3(2) Humeral tubercle yellow spotted. Metatarsus 1 and 2 distally on the inner side with 4-5 dark, short strong spines. Antennae as in Fig. 265. Abdomen with yellow lateral spots on terga 1 and 2, and sometimes also on tergum 3. Spots on tergum 1 often missing ..... 81. dimidiatus Jurine
- Humeral tubercle without yellow spot. Spines on apex of tibiae 1 and 2 weak and pale. Antennae as in Fig. 266. Terga 1-3, and occasionally also tergum 4, with yellow lateral spots ..... 82. mimulus Valkeila
- 4(1) Anterior border of clypeus in middle with arcuate

- emargination, on either side delimited by a small longitudinal keel (Fig. 256). Sternum 2 seen in profile strongly convex (Fig. 257) ..... 5
- Anterior border of clypeus without such emargination and without longitudinal keels. Sternum 2, expect in trimaculatus, evenly rounded (Fig. 258) .. 6
- 5(4) Femora and tibiae mainly black. Humeral tubercle black. Sterna 2 and 3 usually with complete transverse, bright yellow bands ..... 75. spinus (Forster)
- All tibiae and tarsi red-yellow. Femora 1 and 2 mainly black, femur 3 red-yellow. Humeral tubercle usually yellow. Terga 2 and 3 with white-yellow lateral spots ..... 76. interruptus (Fabricius)
- 6(4) Last antennal segment long, ventrally with a strong excavation, in which is found a row of short, ventrally directed hairs ..... 7
- Last antennal segment short, slightly excavate, without hair fringe ventrally. Pronotum usually black, but may have a single, or very rarely 3, small yellow spots. Sternum 2 seen in profile strongly convex ..... 77. trimaculatus (Rossi)
- 7(6) Scutellum always black. Emargination of last antennal segment weak (Fig. 263) ..... 78. niger Chevrier
- Scutellum with yellow transverse spot. This may sometimes be very reduced or absent. Emargination of last antennal segment deep (Fig. 261). 79. maculosus (Gmelin)

75. NYSSON SPINOSUS (Forster, 1771)  
Figs. 255-257.

Sphex spinosus Forster, 1771:87.

Female: 10-12 mm. Pronotum and first three terga with bright yellow transverse bands. Humeral tubercle black. Frons in front of ocelli rather coarsely, longitudinally rugoso-punctate. Clypeus shining, with rather coarse and sparse punctures and also fine, dense punctation, missing in an area along anterior border. Anterior border with U-shaped central emargination, on either side delimited by a short longitudinal keel (Fig. 256). The very dense, pitted sculpture on scutum somewhat irregular, since the pits

are of very unequal size. Interstices, especially in anterior fourth, densely set with fine punctures. Pubescence of head and scutum grey-yellow. Mesopleuron coarsely and densely reticulo-punctate, partly with thin, sateen-like, shining pubescence, partly with sparse erect hairs. Scutellum irregularly, longitudinally rugose. Propodeum dorsally in front of lateral spine with long and sparse pubescence, otherwise with very strong ribs. First tergum closely and rather deeply pitted on anterior part. Legs red-yellow with darker femoral bases.

Male: 9-11 mm. Head in front view very broad above the strongly convex eyes. Frons slightly excavate with densely pitted sculpture, which only in front of the median ocellus shows an indication of longitudinal striation. Inner orbits weakly emarginate. Anterior border of clypeus with small arcuate emargination, delimited by two short longitudinal keels. Lower part of face, inner orbits and clypeus with dense silvery pubescence. Last antennal segment without excavations ventrally. Frons with long and erect grey-yellow pubescence. Yellow transverse spot on pronotum usually present. Sometimes it is reduced to two smaller ones. Scutum with irregular rugose sculpture, often with a tendency to form longitudinal striation as on scutellum. Venter with dense, adpressed, silvery pubescence. Legs black with red-yellow knees and tarsi.

The species seems to have a south-eastern distribution pattern in Denmark. - Rather common in Sweden up to Dlr. and Hls. - Norway: not uncommon in the southern and south-eastern districts. - Finland: rather common, especially in the southern and south-eastern districts, northwards to Ok and Ks. - Soviet Karelia: Ib and Kr. - Known from all European countries and also recorded from the Ussuri region in eastern Siberia; and Japan (a subspecies). Distribution in southern Siberia not known.

The most common species of Nysson in Europe. Stated to live as a cleptoparasite in nests of Gorytes laticinctus (Lep.), G. quadrifasciatus (Fabr.), Argogorytes mystaceus (L) and A. fargei (Shuck.). Often seen licking nectar in flowers, e.g. of Knautia, Succisa, Jasione and several Umbelliferae.

76. NYSSON INTERRUPTUS (Fabricius, 1798)

Mellinus interruptus Fabricius, 1798:266.

Female: 7-9 mm. Pronotum, humeral tubercles and the first three terga with white-yellow pattern. Spots on abdomen seldom coalescing. Frons very densely and coarsely punctate, sculpture very irregular, however, not coalescing longitudinally. Anterior border of clypeus with distinct emargination, on

either side delimited by distinct, almost teeth-like projections. Scutum coarsely, densely and regularly pitted, with fine dense punctation between the large punctures in anterior third. Sculpture of scutellum consisting of oblong punctures, indicating longitudinal striation. Mesopleuron densely and coarsely reticulate-rugose, partly with thin and short silvery pubescence, partly with scattered long hairs. Tergum 1 coarsely punctate, the anterior part with distinct striation. Legs red-yellow, femur 1, however, often partly black.

Male: 7-9 mm. Yellow transverse band of pronotum always complete. Humeral tubercle with yellow mark which, however, may be missing in specimens from Sweden and Finland. The animal covered all over with silvery pubescence, especially pronounced on clypeus and ventrally on thorax. Last segment of antennae without emargination, ventrally with fine, longitudinal carina. Sculpture as in female, but somewhat stronger. Legs red-yellow. Femora 1 and 2 often with black markings.

The species has a rather local occurrence in Fennoscandia and Denmark, and does not seem to be as frequent as the preceding species. The distribution is slightly more southern in this area. Northernmost records in Sweden: Gstr. - Not known from Norway. - Finland: to Om and Kb in the north. - Soviet Karelia: Ib and Kr. - Known from all European countries and Asia Minor.

The species occurs in comparatively dry regions, where males as well as females may be met with on sunny leaves and on flowers, e.g. Knautia and Succisa. It is cleptoparasitic on Gorytes quinquecinctus (Fabr.) and G. quadrifasciatus (Fabr.).

77. NYSSON TRIMACULATUS (Rossi, 1790)

Figs. 260, 262.

Crabro trimaculatus Rossi, 1790:95.

Female: 6-8 mm. Pronotum with yellow transverse stripe, humeral tubercle, a transverse spot behind anterior border of scutellum and the spots along posterior border of the first three terga also yellow. Sculpture of head and scutum consists partly of coarse pits, partly of a fine, dense punctation. Interstices considerably smaller than diameter of the pits. Head with sparse, short, whitish pubescence. Anterior border of clypeus with small truncate tooth in middle. Sculpture on distal third of clypeus consists only of rather coarse sparse punctures, the proximal two-thirds are additionally provided with also a very dense and fine punctation. Mesopleuron very densely and coarsely reticulate; with sparse, greyish pubescence. Dorsal face of propo-

deum anteriorly with short, strong, longitudinal ribs, which are connected posteriorly by an often zig-zag transverse rib. Area in front of the lateral spine with dense, whitish pubescence. Sternum 2 seen in profile strongly convex. Tergum 1 coarsely and rather densely punctate, basally with longitudinal striation. Terga 1-3 with yellow lateral spots which may be fused into a transverse band on tergum 1. Legs black.

Male: 6-8 mm. Pronotum and scutellum usually without yellow pattern. Occasional individuals may, however, have faint yellow spots dorsally on pronotum and its humeral tubercles. Antennae distally strongly thickened. Proximal flagellar segments ventrally with a row of thin, ventrally directed, pale hairs. Last antennal segment short, penultimate segment as long as broad, less than twice as long as the one before it (Fig. 262). Sculpture as in female, only a little stronger. Clypeus with dense, silvery pubescence.

Denmark: very limited material from NEZ. - Sweden: rare, but rather widely distributed from Sk. to Vrm. and Gstr. - Norway: a few specimens from AK, VE and AAy. - Not known from Finland and Soviet Karelia, where niger is a common species. The distribution of trimaculatus and niger in Fennoscandia is interesting, since they seem to be allopatric. In other parts of Europe, however, the two species occur sympatrically. In contrast to niger, trimaculatus occurs in North-West Germany, just south of the Danish border, and therefore might have invaded Denmark from the south. The populations in Sweden might derive from specimens coming either from Denmark (Zealand) or via Bornholm. - The species is rare, but widely distributed, in Europe and Japan.

The species lives as cleptoparasite on Gorytes laticinctus (Lep.) and G. quadrifasciatus (Fabr.).

78. NYSSON NIGER Chevrier, 1868

Fig. 263.

Nysson niger Chevrier, 1868:383.

Nysson erytropoda Yasumatsu, 1942:111.

Female: 5.5 - 7.5 mm. Clypeus with straight or slightly arcuately emarginate anterior border; its punctation considerably finer than in trimaculatus. Area in front of ocelli with comparatively superficial and fine punctation, only slightly mixed with larger and deeper punctures. The double sculpture on scutum is dominated by the finer punctures, since the distance between the large and rather shallow pits is greater than the diameter of these. Sculpture on thorax on the whole distinctly finer than in trimaculatus. Abdomen with

yellow lateral spots on terga 1-3. All tibiae red-yellow, femora 1 and 2 mainly black, femur 3 red-yellow. Sternum 1 in profile weakly swollen (Fig. 258).

Male: 5-7 mm. Pronotum usually with a dorsal yellow transverse spot and yellow humeral tubercles. Scutellum always entirely black in European specimens. Clypeus very slightly convex, its protruding anterior border in the middle very slightly arcuately emarginate (considerably less than in maculosus). Antennae as Fig. 263. Otherwise very similar to maculosus.

In Fennoscandia this species only occurs in southern Finland, towards the north to Om and Kb, and on Gotland in Sweden. The very closely related trimaculatus occurs on the neighbouring island of Öland, and in South Sweden. Niger might therefore have invaded Finland from the east. - Widely distributed, but fairly rare in Central and East Europe, eastwards to Kazakhstan, Mongolia and China.

The species is probably cleptoparasitic on Gorytes laticinctus (Lep.) (Lefeber, 1967).

79. NYSSON MACULOSUS (Gmelin, 1790)

Figs. 258, 261.

Sphex maculosus Gmelin, 1790:2731.

Nysson maculatus auctt.

Female: 7-9 mm. Head in front view very broad. Frons densely and strongly punctate, ventrally mixed with coarser punctures. Protruding median part of clypeus weakly bilobed. Anterior part naked, shiny with scattered, rather coarse punctation; posterior part with sparse, silvery pubescence and double punctation. Antennae rather short and strong. Pronotum with white-yellow transverse spot. Humeral tubercle also with white-yellow pattern. Scutum partly with scattered coarse pits, partly with dense, rather fine punctation. Scutellum usually with white-yellow transverse spot along anterior border. Mesopleuron somewhat superficially and irregularly sculptured, laterally with sharp, vertical carina. Area below base of hindwings with short, stout transverse costae. Area just in front of lateral spine of propodeum with white, felty pubescence. Tergum 1 of abdomen red, posteriorly with two small white-yellow spots. Posterior border in middle with a triangular black spot. Terga 2 and 3 with long, narrow, white-yellow lateral spots. Legs red-yellow, femora 1 and 2, however, mainly black.

Male: 6-8 mm. Pronotum, humeral tubercle, scutellum and three first terga with white-yellow pattern. Spots on abdomen never coalescing. Tergum

1 without red pattern. The strongly silvery pubescence on lower part of face and on clypeus consists of strongly depressed hairs. Antennae much thickened apically. Last antennal segment a little more than twice as long as broad, ventrally with strong, slightly obliquely placed excavation, at the bottom of which a slightly S-shaped carina is found. Antennal segments 4-12 considerably broader than long. Segments 3-5 ventrally with a few, long, ventrally directed hairs (Fig. 261). Sculpture as in female. Legs yellow or red-yellow with black femora.

The species is found in most districts of Denmark, locally in rather large numbers, also where neither Dienoplus tumidus nor lunatus have been found. In Sweden the species is distributed from Sk. in the south to Gstr. in the north. It is rather common on Öland and Gotland, where tumidus is also frequent. - Not known from Norway. - Finland: very limited distribution in the south-eastern districts (Sa). - Soviet Karelia: Ib and Kr (several localities). - Large distribution in Europe, Kazakhstan, China and Korea.

Common, mainly in dry, sandy localities, where the females are seen swarming low above the ground, searching for nests of Dienoplus tumidus (Panz.) (no. 72). Having found such nests, the female will remove the loose sand plug which seals the entrance, and enter. The very small egg is deposited under the wing of one of the paralyzed Cicadas. Then the nest is left and sealed again. The maculosus egg hatches very soon, and the young larva at once seeks the still unhatched egg of the "host" in order to devour it. Later on it feeds on the provision.

80. NYSSON TRIDENS Gerstäcker, 1867  
Figs. 259, 264.

Nysson tridens Gerstäcker, 1867:106.

Female: 5-6 mm. Pronotum and scutellum without yellow pattern. Humeral tubercle yellow. Frons convex, evenly and densely punctate. Silvery pubescence on clypeus sparse. Anterior border almost straight. Occipital carina very distinct, especially near anterior part of head. Pronotum and scutum with golden-brown, densely adpressed pubescence. First, and partly second, tergum red. White-yellow spots always present on tergum 2; but may be absent from terga 1 and 3. Legs red-yellow to rusty with brown femora.

Male: 4-6 mm. Antennae only very slightly thickened apically, last segment simple, without excavation, only slightly longer than the penultimate segment (Fig. 264). Posterior face of head with distinct occipital carina.

Only tergum 1 red (may, however, be almost entirely black in very small individuals). Lateral spots usually missing on tergum 3.

A typical southern element in the Danish and Swedish faunas (SJ, EJ, LFM, NEZ and Sk., Arild). - Not known from Norway and Finland. - Widely distributed, but sporadic in Europe. Also recorded from Kazakhstan and Mongolia. - Cleptoparasite on Dienoplus tumidus (Panz.) and lunatus (Dahlb.).

Note. Specimens with completely or partly black tergum 1 were described by Müller, 1918 under the name N. tridens var. melas, but this cannot be regarded as a subspecies, since it occurs sympatrically with the nominate form in several places in the distribution area. The problem needs, however, further investigation.

81. NYSSON DIMIDIATUS Jurine, 1807  
Fig. 265.

Nysson dimidiatus Jurine, 1807:191.

Nysson wesmaeli Lepeletier, 1845:50.

Female/male: 4-6 mm. Very closely related to the preceding species, but can be distinguished by the following characters. Lower part of occipital carina missing. Head ventrally finely, but slightly irregularly striate. Anterior border of clypeus weakly arcuately dilated. In addition, the last antennal segment of the male is very large, more than twice as long as broad, ventrally with double emargination (Fig. 265).

Known from most districts in Denmark. In Sweden, Norway and Finland the northern distribution limit is similar to that of its host. In some districts in Norway (On) and Finland (ObN) dimidiatus apparently occurs north of the distribution area of tumidus, but still within the limits of that of lunatus. The species is distributed throughout most of Europe, and it also occurs in Kazakhstan. - Cleptoparasitic on Dienoplus tumidus (Panz.).

82. NYSSON MIMULUS Valkeila, 1964  
Fig. 266.

Nysson mimulus Valkeila, 1964:197.

Nysson friesei f. handlirschi Westerlund sensu Hellén, 1954:125.

4-6 mm. Closely related to dimidiatus. Scutum with double sculpture. Interstices smaller than the diameter of the large punctures. Occasional females have a yellow-brown mark instead of a yellow one on the humeral



tubercles. Ribs on pronotum very strong. Abdomen with yellow lateral spots on terga 1-3 and sometimes also on tergum 4 (males). Last antennal segment of males as Fig. 266.

The species is rather common in Finland: Åland, where *dimidiatus* has not been found. *Dienoplus tumidus* (Panz.) may thus play the rôle of 'host', especially on Åland, where *D. lunatus* (Dahlb.) apparently does not occur. *Mimulus* is fairly rare in Finland, but distributed over large areas, especially in the south-eastern districts, northwards to Kb and Sb. - In Sweden the species is recorded from Gstr. and Med. - The distribution in Central Europe and Fennoscandia suggests a boreo-alpine pattern.

## Genus *Didineis* Wesmael

*Didineis* Wesmael, 1852:109.

Type-species: *Pompilus lunicornis* Fabricius, 1798.

Closely related to *Alysson* but distinguishable by the following characters: Inner orbits distinctly converging ventrally, more strongly in males than females. Distance between antennal sockets in both sexes less than greatest breadth of scapus. Scapus in males about twice as long as broad. Last antennal segment in males (Fig. 267) strongly curved in a C-shape, penultimate segment spinose ventrally. Yellow or yellow-brown pattern on face limited to anterior border of clypeus and only present in females. Propodeum evenly rounded posteriorly without transverse carina, but with two posteriorly directed spines. Tergum 2 without yellow pattern. Forewing nervulus is strongly postfurcal (Fig. 268). Tibia 2 with two spurs. Tibia 3 of female with a proximal row of very short spines.

The genus has a Holarctic distribution, but comprises only a few species. Nests are constructed in the ground. Six species in Europe, only a single in the North. The prey consist of Homoptera Sternorrhyncha.

83. *DIDINEIS LUNICORNIS* (Fabricius, 1798)

Figs. 267, 268.

*Pompilus lunicornis* Fabricius, 1798:249.

Female: 7-8 mm. Frons in front of ocelli densely and finely punctate, the punctures often having a tendency to coalesce longitudinally. Clypeus short, posteriorly strongly punctate. Anterior half yellow or brown-yellow, anterior border with three teeth, of which the central is considerably stronger than

the lateral ones. Mandibles yellow with red-brown apex. Pronotum long and narrow, laterally with a weakly striate or transversely rugose sculpture, dorsally finely and densely punctate like scutum. Humeral tubercle posteriorly slightly brownish, without yellow mark. Scutellum black. Mesopleuron finely rugoso-punctate, often with indication of striae. Propodeum dorsally with apically attenuate area, with irregular, usually longitudinal sculpture, which consists of undulating carinae. Oblique, regular carinae run back from the delimiting carinae of the area. Two first segment of abdomen red without yellow pattern. The ventrally directed spinose dilation on apex of femur 3 considerably weaker than in *Alysson*.

Male: 5.5 - 7 mm. Much more slender than female. Frons in front of ocelli evenly and finely punctate, with shining interstices. Punctures without

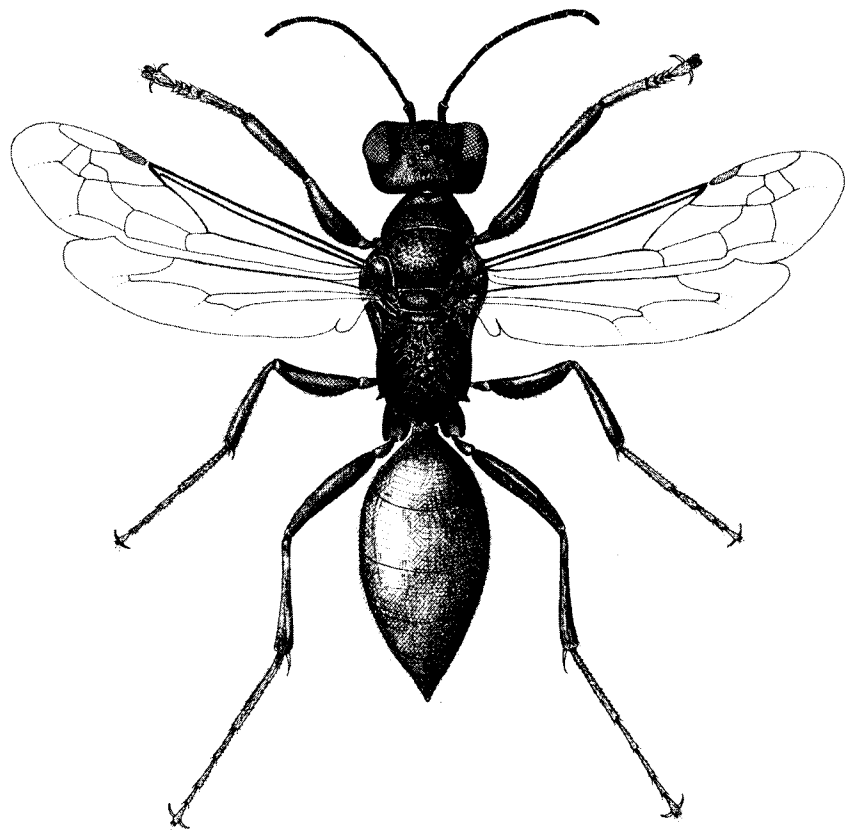

Fig. 268. Female of *Didineis lunicornis* (Fabr.). Length: 7-8 mm.

tendency to coalesce longitudinally. Clypeus uniform black, its anterior border slightly undulating, without teeth. Mandibles red-yellow with rusty apex. Antennae very long and slender, last segment strongly curved in a C-shape, penultimate segment distally on ventral face with forwardly directed spine (Fig. 267). Thorax and propodeum sculptured as in female. Abdomen with long and sparse pubescence, its base red. Posterior border of tergum 2 more or less dark. Tarsi long and slender.

Rather little, old material (last capture:1913) exists from Danish localities, predominantly from the southern districts (SJ, EJ and SZ). - The species is not recorded from Fennoscandia, but is known both from Great Britain and North Germany. This species is not common, but widespread in Europe and the Mediterranean area. Also occurring in Mongolia.

Nests in small banks and in horizontally placed localities with sparse vegetation. The nest consists of a rather long tunnel, terminating in a single cell. This cell is provisioned with Heteroptera, Homoptera, usually of the family Cicadellidae.

## Genus *Alysson* Panzer

*Alysson* Panzer, 1806:169.

Type-species: *Pompilus spinosus* Panz., 1801.

Small, rather rare species (Fig. 269). Head fairly small, about as broad as thorax. Inner orbits almost parallel in females, distinctly converging ventrally in males. Distance between antennal sockets greater than width of scapus in female, but considerably smaller in males. This is partly due to the very short, thick scapus in the males. Clypeus short and broad, in females with three distinct teeth on anterior border. Mandibles weakly bidentate. Antennae long and slender, in males the last segment is slightly excavate ventrally. Inner orbits, clypeus, mandibles and scapus with more or less extensive yellow marking. Pronotum elongate, almost neck-like. Thorax otherwise rather narrow, shining, weakly punctate dorsally. Mesopleuron without well-defined epicnemium. Propodeum very long, with strong carinae and ribs, dorsally forming a triangular area. On the junction between posterior and lateral faces of propodeum there are indistinct tubercles. Abdomen sessile, with a pair of round yellow or whitish spots on tergum 2. Tergum 6 in female with distinct pygidial areal. Tergum 7 of male flat, tergum 9 with a pair of sting-like prolongations. Forewings with three cubital cells, of which the second is petiolate. Stigma large. Nervulus inter-

stitial or slightly antefurcal. Legs long and slender. Anterior metatarsi in female with or without very weak pecten, pretarsus and pulvilli very well developed. Tibia 2 with a single, weakly developed spur. Femur 3 distally on the outer side with a well developed, ventrally directed, spinose dilation (Fig. 272). Tibia 3 of females with a double row of long, pale spines.

The genus is distributed in Holarctis, with about 12 species. The species nest in the soil. The main tunnel either terminates in a single cell (Nordic species), or leads to a system of short side tunnels, each terminating in a cell (Japanese species). Prey consists of Homoptera Sternorhyncha. The egg is laid on the last deposited prey.

### Key to species of *Alysson*

- 1 Area on dorsal surface of propodeum rounded posteriorly or indistinctly delimited, with irregular, partly reticulate coalescing rugae (Fig. 270). Female: base of abdomen red; scutellum usually with a white-yellow spot. Male: flagellum uniform black ..... 84. *spinus* (Panzer)

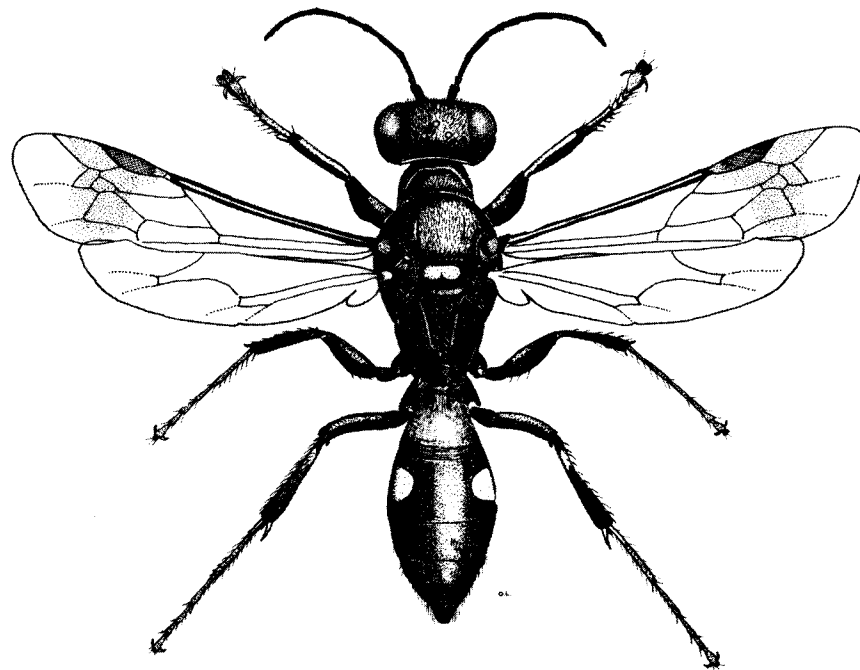

Fig. 269. Female of *Alysson spinosus* (Panz.). Length: 7-8 mm.

- Area on dorsal surface of propodeum concave, posteriorly attenuate; with strong, regular longitudinal carinae (Fig. 271).  
Female: abdomen without red pattern; scutellum black.  
Male: flagellum ventrally brown-yellow.... 85. ratzeburgi Dahlbom

84. ALYSSON SPINOSUS (Panzer, 1801)  
Figs. 269, 270, 272.

Sphex bimaculatus Panzer, 1798: H. 51, T. 4 (preocc.).

Pompilus spinosus Panzer, 1801: H. 80, T. 17.

Female: 6.5 - 8 mm. Inner orbits almost parallel. Frons in front of ocelli densely and strongly punctate. Area between antennal sockets broad, slightly swollen. Lower part of face with silvery pubescence. As a rule with extensive yellow pattern along inner orbits, laterally on clypeus, on anterior part of scapus and on mandibles. This colour pattern is most extensive in specimens from Central and South Europe. In Danish specimens it is very limited and often absent from large parts of clypeus. Anterior border of clypeus with three distinct teeth, of which the median is somewhat more strongly developed than the lateral. Third antennal segment distinctly longer than fourth. Pronotum dorsally very finely punctate, laterally striate. Along posterior border a rather deep furrow, whose bottom is partitioned by weak transverse carinae. Scutellum usually with a double yellow spot. Mesopleuron shining, almost impunctate. Dorsal area on propodeum rather narrow, centrally with two more or less distinct longitudinal ribs. From these, branched, oblique rugae often originate (Fig. 270). The area posteriorly rounded or truncate. Propodeum laterally with very small tubercles. Posterior face not distinctly delimited from remaining part of the sclerite. Tergum 1 red, 2 black with two large, white-yellow spots. Femora black. Tibia 1 with yellow longitudinal stripe along anterior border, tibia 3 with yellow proximal ring. Pretarsus and pulvillus very well-developed. Apical tooth on femur 3 as Fig. 272..

Male: 4.5 - 6,5 mm. Somewhat more slender than female. Head in front view broader than long. Clypeus without teeth on anterior border. Pattern on face as in female, light yellow, but the expansion of the colour more limited on clypeus. Scapus thick and short. Antennae comparatively short, ventrally brown-black, last segment truncate, ventrally with a very weak excavation. Humeral tubercle usually with yellow spot, extending a short distance along posterior border of pronotum. Scutellum usually black, but may bear two indistinct yellow spots. Sculpture on propodeum relatively somewhat stron-

ger than in female. Tergum 1 black, 2 with two yellow spots. Coxa 1 and trochanter 1, coxa 2, tibia 1 on the outer side and tibia 2 proximally with yellow pattern. Last abdominal segment red-yellow.

In the North only recorded from Denmark: F, several localities. - Known from Central and southern Europe. Rare.

The nests are constructed at the base of slopes exposed to the sun; where the soil consists of sand or gravel. The tunnel at first runs horizontally for some distance, then it turns, running almost vertically down. The number of cells probably varies, but according to previous authors the species constructs only a single cell per entrance. The paralyzed prey (usually Cicadellidae, e. g. Philaenus spumarius L) are flown almost the whole way to the nests, being held exclusively with the mandibles. The last part of the journey to the entrance is made on foot.

85. ALYSSON RATZEBURGI Dahlbom, 1843  
Fig. 271.

Alysson ratzeburgi Dahlbom, 1843:145.

Female: 7-8 mm. Inner orbits distinctly converging ventrally. Frons in front of ocelli finely and rather sparsely punctate, with shiny appearance, distance between punctures being as great as or greater than the diameter of the punctures. Area between antennal sockets slightly swollen, often with a yellow spot. Silvery pubescence on face very sparse, limited to a small

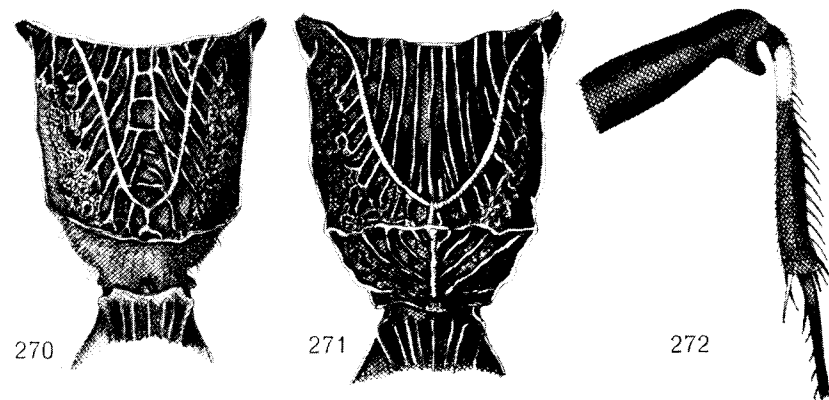

Figs. 270-271. Propodeum in dorsal view of female Alysson. - 270: spinosus (Panzer); 271: ratzeburgi Dahlbom.  
Fig. 272. Hindleg of female Alysson spinosus (Panzer).

spot between lower part of eyes and antennal sockets. Yellow pattern of face considerably less extensive than in spinosus, there being usually a narrow yellow or yellow-brown band along the inner orbits. Mandibles brown-yellow with red-brown apex. Yellow spot on anterior side of scapus may be absent. Clypeus without yellow pattern, the shiny impunctate anterior area separated from the posterior, rather densely punctate half by a row of large, deep, bristle-bearing punctures. Anterior border with a broad, rounded, median tooth, lateral teeth very small. Antennal segments 3 and 4 almost equally long. Furrow along posterior border of pronotum very weakly developed, without transverse carinae in the bottom. Scutellum without yellow marking. Propodeum distinctly concave dorsally. Triangular area broad (Fig. 271) with comparatively regular longitudinal carinae. Posterior face of propodeum delimited from the lateral and dorsal faces by well-developed carinae, forming a small tubercular thickening where the three areas meet. Abdomen without red, spots on tergum 2 yellow. Mid- and hindlegs mainly red-yellow. Forelegs red-yellow with black femora. Coxa 1 with yellow or red-yellow distal spot.

Male: 6-7 mm. Clypeus, two large, triangular spots along inner orbits and a spot extending from posterior border of clypeus up between antennal sockets, bright lemon-coloured. Mandibles, palps and scapus also with extensive yellow markings. Antennae ventrally brown-yellow, distally gradually darker. Last antennal segment somewhat more excavated than in spinosus. Posterior border of humeral tubercle yellowish. Often two yellow spots are present on pronotum. Scutellum with or without yellow pattern. Sculpture on propodeum stronger than in female, triangular area more concave. Tergum 2 with lemon-coloured lateral spots. Last abdominal segment red-brown. Coxa 1 distally with a small spine-like prolongation. Forelegs ventrally, including coxae and trochanters, with very extensive yellow markings. Foretarsi black-brown. Fore- and midlegs with more or less extensive yellow and yellow-brown pattern, tibia 3 uniform yellow-brown.

A northern species which is rather common in Central and North Sweden up to Vb. and Ly. Lpm. Not recorded from the southern districts. - Norway: a few specimens from AK. - Finland: widespread but rare from Al in the south to Ks, Li and ObN in the north. - Soviet Karelia: Ib, Kr and Lr. - Recorded from Central and East Europe. Additional records from Japan and Korea. Distribution through southern Siberia unknown.

Biology as in preceding species.

## SUBFAMILY MELLININAE

The taxonomical status not fixed. The group was treated as a tribe within the Nyssoninae by Bohart and Menke (1975), Beaumont (1954) and several others, whereas Evans (1959) gave it subfamily rank, concluding from larval morphology that the group is apparently not closely related to the Nyssoninae. As concerns subfamily characters of imagines, see generic description of Mellinus. In addition, it should be noticed that the epicnemium is not differentiated, since the epicnemial carina is absent and the transverse discoidal veins join first and third cubital cells, respectively. The latter character is only found in Ampulex (Ampulicinae) and some Pison (Larrinae, Trypoxylonini), suggesting it to be rather primitive. The only specialized character of imagines might be the petiolate abdomen.

As regards larval morphology the following description is based only on the single species being described. Body with pleural lobes and a series of dorso-lateral prominences conically produced, dark-tipped, and armed with numerous short, stout spinules (Figs. 37, 38). Integument otherwise smooth. Parietal bands only indicated. Antennal papillae absent. Apical margin of labrum bristly, with a strong V-shaped emargination. Mandibles bidentate, strongly excavate proximally. Maxillary palpus slightly longer than galea. Maxillae directed medially. Spinneret paired, the salivary openings at the tip of slender prolongations, proximally connected by a membrane.

The subfamily only comprises a single genus. Probably all species display terrestrial nesting habits.

## Genus *Mellinus* Fabricius

Mellinus Fabricius, 1790:226.

Type-species: Vespa arvensis Linné, 1758.

Rather large, easily recognizable species (Fig. 273) with extensive and very variable yellow pattern. Head large, in front view broader than long. In females the lower two-thirds of inner orbits of eyes are parallel, whereas they are distinctly converging downwards in the males. Antennae long, filiform, inserted far from each other. Clypeus with three rounded teeth on anterior border, its yellow or white-yellow pattern most strongly developed in the males. Mandibles stout, in females tridentate, in males bidentate. Thorax with yellow pattern on pronotum, scutellum, and mesopleuron. Propodeum elongate, slightly convex, dorsally with distinctly delimited area